

# Atlas Concorde

## Generel katalog 2023



# Flisestudiet

  
**Italiensk flisedesign**

# Collections

# 2023

General Catalog

INTERACTIVE VERSION

## Index

### Product Finder

- ↔ ALPHABETICAL INDEX
- ↔ LOOK INDEX
- ↔ PORCELAIN TILES SIZE INDEX
- ↔ OUTDOOR SIZE INDEX
- ↔ WALL TILES SIZE INDEX

### Surface Range

- ↔ PORCELAIN TILES
- ↔ WALL TILES

### Company

### Collections

- ↔ 3D WALL
- ↔ CONCRETE & RESIN LOOK
- ↔ METAL LOOK
- ↔ MARBLE LOOK
- ↔ STONE LOOK
- ↔ WOOD LOOK

- ↔ Trim Tiles

### ↔ Large Sizes

### ↔ Slabs for Countertops & Furniture

### ↔ Sinks & Bathroom Furnishing

### ↔ Facades

### Technical Specifications

- ↔ Certifications
- ↔ Technical features
- ↔ Sensitech technology
- ↔ Anti-slip classification
- ↔ Laying suggestions, cleaning and maintenance
- ↔ Packing
- ↔ General sales conditions

A COMPLETE PRODUCT SYSTEM >

PRODUCT FINDER >

SURFACE RANGE >

COMPANY >

COLLECTIONS >

LARGE SIZES >

SLABS FOR COUNTERTOPS & FURNITURE >

SINKS & BATHROOM FURNISHING >

FACADES >

TECHNICAL SPECIFICATIONS >

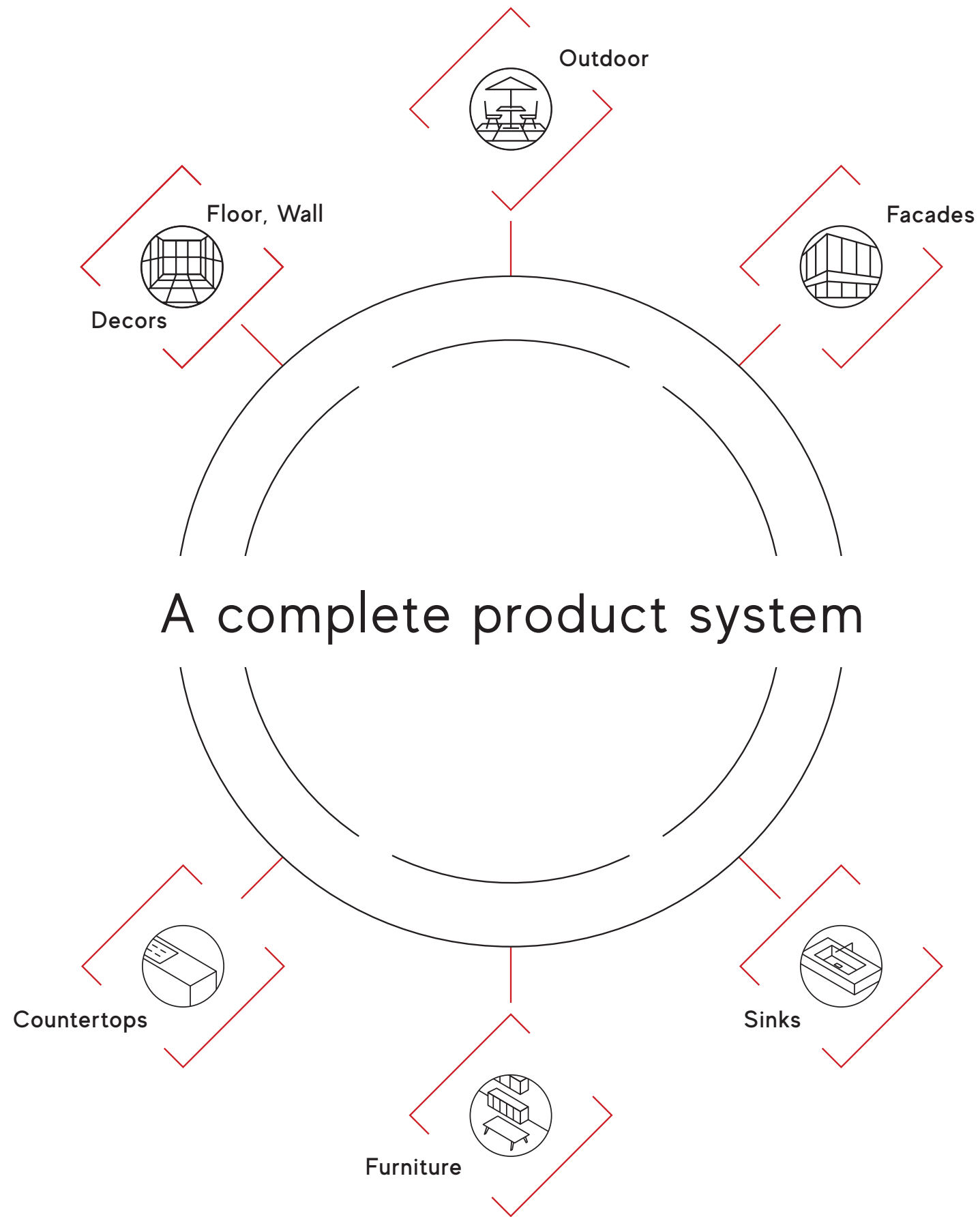

A system of indoor and outdoor surfaces: floors, walls, and decors.



Large slabs for kitchen countertops, tables, and furnishings.



Washbasins and bathroom furnishings in combination with Atlas Concorde surfaces.



Our product system is designed to create complete, coordinated interiors and exteriors. With our brands we offer a stylistic selection of functional surfaces and products for every space.

Il nostro sistema di prodotto è pensato per realizzare ambienti completi e coordinati. Attraverso i nostri brand offriamo una proposta stilistica di superfici e prodotti funzionali per ogni spazio.

Notre système de produits est conçu pour créer des ambiances complètes et coordonnées. À travers nos marques, nous offrons une proposition stylistique de surfaces et de produits fonctionnels pour chaque espace.

Unser Produktsystem ist darauf ausgelegt, Räumlichkeiten komplett und koordiniert zu gestalten. Mit unseren Marken bieten wir stilistisch ansprechende Beläge und funktionelle Produkte für jedes Ambiente.

Nuestro sistema de productos está diseñado para crear ambientes completos y combinados. A través de nuestras marcas, ofrecemos una propuesta estilística de superficies y productos funcionales para todos los espacios.

Наша продуктовая система задумана для комплексного оформления интерьеров. Посредством наших брендов мы предлагаем широкий ассортимент функциональных изделий и плитки для любого пространства.

A COMPLETE PRODUCT SYSTEM >

PRODUCT FINDER >

SURFACE RANGE >

COMPANY >

COLLECTIONS >

LARGE SIZES >

SLABS FOR COUNTERTOPS & FURNITURE >

SINKS & BATHROOM FURNISHING >

FACADES >

TECHNICAL SPECIFICATIONS >

# Alphabetical Index

[86](#) 3D WALL CARVE <sup>(1)</sup> <sup>(2)</sup>

[90](#) 3D WALL DESIGN

[244](#) AIX

[94](#) APLOMB <sup>(1)</sup>

[100](#) ARTY

[312](#) AXI

[150](#) BLAZE

[106](#) BOOST

[252](#) BOOST MIX

[114](#) BOOST NATURAL <sup>(1)</sup>

[122](#) BOOST PRO

[258](#) BOOST STONE

[264](#) BRAVE

[104](#) CANONE INVERSO

[130](#) DWELL

[316](#) ENTICE

[322](#) ETIC

[326](#) ETIC PRO

[332](#) EXENCE

[340](#) HEARTWOOD

[272](#) KLIF

[278](#) KONE

[284](#) LIMS

[158](#) MARVEL

[170](#) MARVEL DREAM

[178](#) MARVEL EDGE

[188](#) MARVEL GALA

[192](#) MARVEL GEMS

[194](#) MARVEL PRO

[206](#) MARVEL SHINE

[218](#) MARVEL STONE Marble Look

[292](#) MARVEL STONE Stone Look

[228](#) MARVEL TRAVERTINE

[236](#) MARVEL X

[344](#) NID

[298](#) NORDE

[134](#) PRISM

[306](#) TRUST

[144](#) VENTI BOOST



CATALOGS DOWNLOAD

# Look Index

## 3D Wall

[86](#) 3D WALL CARVE <sup>(1)</sup> <sup>(2)</sup>

[90](#) 3D WALL DESIGN

[94](#) APLOMB <sup>(1)</sup>

[100](#) ARTY

## Concrete & Resin Look

[106](#) BOOST

[114](#) BOOST NATURAL <sup>(1)</sup>

[122](#) BOOST PRO

[104](#) CANONE INVERSO

[130](#) DWELL

[134](#) PRISM

[144](#) VENTI BOOST

## Metal Look

[150](#) BLAZE

## Marble Look

[158](#) MARVEL

[170](#) MARVEL DREAM

[178](#) MARVEL EDGE

[188](#) MARVEL GALA

[192](#) MARVEL GEMS

[194](#) MARVEL PRO

[206](#) MARVEL SHINE

[218](#) MARVEL STONE

[228](#) MARVEL TRAVERTINE

[236](#) MARVEL X

## Stone Look

[244](#) AIX

[252](#) BOOST MIX

[258](#) BOOST STONE

[264](#) BRAVE

[272](#) KLIF

[278](#) KONE

[284](#) LIMS

[292](#) MARVEL STONE

[228](#) MARVEL TRAVERTINE

[298](#) NORDE

[306](#) TRUST

## Wood Look

[312](#) AXI

[316](#) ENTICE

[322](#) ETIC

[326](#) ETIC PRO

[332](#) EXENCE

[340](#) HEARTWOOD

[344](#) NID



reddot winner 2022  
(1)



(2)

A COMPLETE PRODUCT SYSTEM >

PRODUCT FINDER >

ALPHABETICAL INDEX  
LOOK INDEX  
PORCELAIN TILES SIZE INDEX  
OUTDOOR TILES SIZE INDEX  
WALL TILES SIZES INDEX

SURFACE RANGE >

COMPANY >

COLLECTIONS >

LARGE SIZES >

SLABS FOR COUNTERTOPS & FURNITURE >

SINKS & BATHROOM FURNISHING >

FACADES >

TECHNICAL SPECIFICATIONS >

# Porcelain Tiles Size Index

## 162x324 402 SLABS FOR COUNTERTOPS & FURNITURE 159x324

	<b>160x320</b>	<b>106</b>	BOOST	Concrete Look
		<b>122</b>	BOOST PRO	Concrete Look
		<b>158</b>	MARVEL	Marble Look
		<b>194</b>	MARVEL PRO	Marble Look
		<b>206</b>	MARVEL SHINE	Marble Look
		<b>218</b>	MARVEL STONE	Marble Look

	<b>160x160</b>	<b>106</b>	BOOST	Concrete Look
		<b>122</b>	BOOST PRO	Concrete Look
		<b>158</b>	MARVEL	Marble Look
		<b>194</b>	MARVEL PRO	Marble Look
		<b>206</b>	MARVEL SHINE	Marble Look
		<b>218</b>	MARVEL STONE	Marble Look

	<b>120x278</b>	<b>150</b>	BLAZE	Metal Look
		<b>106</b>	BOOST	Concrete Look
		<b>252</b>	BOOST MIX	Stone Look
		<b>114</b>	BOOST NATURAL	Concrete Look
		<b>122</b>	BOOST PRO	Concrete Look
		<b>292</b>	BOOST STONE	Stone Look
		<b>284</b>	LIMS	Stone Look
		<b>158</b>	MARVEL	Marble Look
		<b>170</b>	MARVEL DREAM	Marble Look
		<b>178</b>	MARVEL EDGE	Marble Look
		<b>188</b>	MARVEL GALA	Marble Look
		<b>194</b>	MARVEL PRO	Marble Look
		<b>206</b>	MARVEL SHINE	Marble Look
		<b>218</b>	MARVEL STONE	Marble Look
		<b>228</b>	MARVEL TRAVERTINE	Marble Look
		<b>236</b>	MARVEL X	Marble Look
		<b>134</b>	PRISM	Concrete Look

	<b>120x240</b>	<b>106</b>	BOOST	Concrete Look
		<b>122</b>	BOOST PRO	Concrete Look
		<b>158</b>	MARVEL	Marble Look
		<b>170</b>	MARVEL DREAM	Marble Look
		<b>178</b>	MARVEL EDGE	Marble Look
		<b>194</b>	MARVEL PRO	Marble Look
		<b>206</b>	MARVEL SHINE	Marble Look
		<b>218</b>	MARVEL STONE	Marble Look
		<b>292</b>	MARVEL STONE	Stone Look
		<b>228</b>	MARVEL TRAVERTINE	Marble Look
		<b>236</b>	MARVEL X	Marble Look

## 120x120 150 BLAZE Metal Look 106 BOOST Concrete Look 252 BOOST MIX Stone Look 114 BOOST NATURAL Concrete Look 122 BOOST PRO Concrete Look 258 BOOST STONE Stone Look 130 DWELL Concrete Look 278 KONE Stone Look 284 LIMS Stone Look 158 MARVEL Marble Look 170 MARVEL DREAM Marble Look 178 MARVEL EDGE Marble Look 188 MARVEL GALA Marble Look 194 MARVEL PRO Marble Look 206 MARVEL SHINE Marble Look 218 MARVEL STONE Marble Look 292 MARVEL STONE Stone Look 228 MARVEL TRAVERTINE Marble Look 236 MARVEL X Marble Look 134 PRISM Concrete Look



## 60x120 116 BOOST Concrete Look 252 BOOST MIX Stone Look 114 BOOST NATURAL Concrete Look 122 BOOST PRO Concrete Look 258 BOOST STONE Stone Look 158 MARVEL Marble Look 170 MARVEL DREAM Marble Look 188 MARVEL GALA Marble Look 194 MARVEL PRO Marble Look 206 MARVEL SHINE Marble Look 218 MARVEL STONE Marble Look 228 MARVEL TRAVERTINE Marble Look 236 MARVEL X Marble Look 298 NORDE Stone Look 134 PRISM Concrete Look



## 75x150 244 AIX Stone Look 150 BLAZE Metal Look 106 BOOST Concrete Look 122 BOOST PRO Concrete Look 264 BRAVE Stone Look 278 KONE Stone Look 272 KLIF Stone Look 284 LIMS Stone Look 158 MARVEL Marble Look 170 MARVEL DREAM Marble Look 178 MARVEL EDGE Marble Look 194 MARVEL PRO Marble Look 206 MARVEL SHINE Marble Look 218 MARVEL STONE Marble Look 292 MARVEL STONE Stone Look 236 MARVEL X Marble Look



## 75x75 244 AIX Stone Look 150 BLAZE Metal Look 106 BOOST Concrete Look 122 BOOST PRO Concrete Look 264 BRAVE Stone Look 278 KONE Stone Look 272 KLIF Stone Look 284 LIMS Stone Look 158 MARVEL Marble Look 170 MARVEL DREAM Marble Look 178 MARVEL EDGE Marble Look 194 MARVEL PRO Marble Look 206 MARVEL SHINE Marble Look 218 MARVEL STONE Marble Look 292 MARVEL STONE Stone Look 236 MARVEL X Marble Look



## 37,5x75 244 AIX Stone Look 272 KLIF Stone Look 284 LIMS Stone Look 206 MARVEL SHINE Marble Look



## 60x60 106 BOOST Concrete Look 252 BOOST MIX Stone Look 114 BOOST NATURAL Concrete Look 122 BOOST PRO Concrete Look 258 BOOST STONE Stone Look 264 BRAVE Stone Look 130 DWELL Concrete Look 278 KONE Stone Look 158 MARVEL Marble Look 170 MARVEL DREAM Marble Look 178 MARVEL EDGE Marble Look 192 MARVEL GEMS Marble Look 194 MARVEL PRO Marble Look 206 MARVEL SHINE Marble Look 218 MARVEL STONE Marble Look 292 MARVEL STONE Stone Look 228 MARVEL TRAVERTINE Marble Look 236 MARVEL X Marble Look 298 NORDE Stone Look 306 TRUST Stone Look



## 30x60 106 BOOST Concrete Look 252 BOOST MIX Stone Look 114 BOOST NATURAL Concrete Look 122 BOOST PRO Concrete Look 258 BOOST STONE Stone Look 264 BRAVE Stone Look 278 KONE Stone Look 158 MARVEL Marble Look 178 MARVEL EDGE Marble Look 194 MARVEL PRO Marble Look 206 MARVEL SHINE Marble Look 218 MARVEL STONE Marble Look 236 MARVEL X Marble Look 298 NORDE Stone Look 134 PRISM Concrete Look 306 TRUST Stone Look



## 45x90 264 BRAVE Stone Look



## 25x150 326 ETIC PRO Wood Look 344 NID Wood Look



## 18,5x150 316 ENTICE Wood Look 332 EXENCE Wood Look 340 HEARTWOOD Wood Look 344 NID Wood Look



## 20x120 316 ENTICE Wood Look 332 EXENCE Wood Look 340 HEARTWOOD Wood Look



## 22,5x90 312 AXI Wood Look 322 ETIC Wood Look 326 ETIC PRO Wood Look



## 15x90 344 NID Wood Look



## 20x20 144 VENTI BOOST Concrete Look



INDEX



A COMPLETE PRODUCT SYSTEM >

PRODUCT FINDER >

ALPHABETICAL INDEX LOOK INDEX

PORCELAIN TILES SIZE INDEX

OUTDOOR TILES SIZE INDEX

WALL TILES SIZES INDEX

SURFACE RANGE >

COMPANY >

COLLECTIONS >

LARGE SIZES >







SLABS FOR COUNTERTOPS & FURNITURE >







SINKS & BATHROOM FURNISHING >

FACADES >





TECHNICAL SPECIFICATIONS >

# Outdoor Size Index

	<b>120x240</b>	106	BOOST	20 mm	Concrete Look
		150	BLAZE	20 mm	Metal Look
		106	BOOST	9/20 mm	Concrete Look
		252	BOOST MIX	20 mm	Stone Look
122		BOOST PRO	9/20 mm	Concrete Look	
	114	BOOST NATURAL	9/20 mm	Concrete Look	
	258	BOOST STONE	20 mm	Stone Look	
	264	BRAVE	20 mm	Stone Look	
	134	PRISM	9/20 mm	Concrete Look	
		106	BOOST	20 mm	Concrete Look
		252	BOOST MIX	20 mm	Stone Look
		122	BOOST PRO	20 mm	Concrete Look
114		BOOST NATURAL	9 mm	Concrete Look	
258		BOOST STONE	9/20 mm	Stone Look	
264		BRAVE	20 mm	Stone Look	
284		LIMS	20 mm	Stone Look	
228		MARVEL TRAVERTINE	9/20 mm	Marble Look	
236		MARVEL X	20 mm	Marble Look	
298		NORDE	9/20 mm	Stone Look	
	306	TRUST	20 mm	Stone Look	
	162	PRISM	20 mm	Concrete Look	
	338	NORDE	20 mm	Stone Look	
	106	BOOST	20 mm	Concrete Look	
	122	BOOST PRO	20 mm	Concrete Look	
	244	AIX	20 mm	Stone Look	
	298	NORDE	20 mm	Stone Look	

	<b>37,5x75</b>	244	AIX	9 mm	Stone Look	
		272	KLIF	9 mm	Stone Look	
		284	LIMS	9 mm	Stone Look	
	<b>60x60</b>	150	BLAZE	20 mm	Metal Look	
		106	BOOST	20 mm	Concrete Look	
		252	BOOST MIX	20 mm	Stone Look	
		122	BOOST PRO	20 mm	Concrete Look	
		114	BOOST NATURAL	20 mm	Concrete Look	
		258	BOOST STONE	20 mm	Stone Look	
		264	BRAVE	20 mm	Stone Look	
		284	LIMS	20 mm	Stone Look	
		298	NORDE	20 mm	Stone Look	
		306	TRUST	20 mm	Stone Look	
	<b>30x60</b>	264	BRAVE	9 mm	Stone Look	
		252	BOOST MIX	9 mm	Stone Look	
		258	BOOST STONE	9 mm	Stone Look	
		278	KONE	9 mm	Stone Look	
		194	MARVEL PRO	9 mm	Marble Look	
		298	NORDE	9 mm	Stone Look	
		306	TRUST	9 mm	Stone Look	
	<b>18,5x150</b>	332	EXENCE	9 mm	Wood Look	
		<b>30x120</b>	316	ENTICE	20 mm	Wood Look
			236	ETIC PRO	20 mm	Wood Look
		332	EXENCE	20 mm	Wood Look	
	<b>20x120</b>	316	ENTICE	9 mm	Wood Look	
	<b>22,5x90</b>	326	ETIC PRO	9 mm	Wood Look	

# Wall Tiles Size Index

	<b>50x120</b>	90	3D WALL DESIGN		
		94	APLOMB	Concrete Look	
		120	BOOST NATURAL	Concrete Look	
		156	BLAZE	Metal Look	
		166	MARVEL	Marble Look	
		176	MARVEL DREAM	Marble Look	
		184	MARVEL EDGE	Marble Look	
		204	MARVEL PRO	Marble Look	
		216	MARVEL SHINE	Marble Look	
		226	MARVEL STONE	Marble Look	
	<b>40x80</b>	86	3D WALL CARVE		
		90	3D WALL DESIGN		
		250	AIX	Stone Look	
		100	ARTY	Concrete Look	
		112	BOOST	Concrete Look	
		128	BOOST PRO	Concrete Look	
		270	BRAVE	Stone Look	
		290	LIMS	Stone Look	
		166	MARVEL	Marble Look	
		184	MARVEL EDGE	Marble Look	
	<b>30,5x91,5</b>	166	MARVEL	Marble Look	
		204	MARVEL PRO	Marble Look	
		<b>30,5x56</b>	90	3D WALL DESIGN	
			166	MARVEL	Marble Look
		<b>8,5x31,5</b>	166	MARVEL	Marble Look
			204	MARVEL PRO	Marble Look
			226	MARVEL STONE	Marble Look



- INDEX 
- A COMPLETE PRODUCT SYSTEM 
- PRODUCT FINDER 
- ALPHABETICAL INDEX
- LOOK INDEX
- PORCELAIN TILES SIZE INDEX
- OUTDOOR TILES SIZE INDEX
- WALL TILES SIZES INDEX
- SURFACE RANGE 
- COMPANY 
- COLLECTIONS 
- LARGE SIZES 
- SLABS FOR COUNTERTOPS & FURNITURE 
- SINKS & BATHROOM FURNISHING 
- FACADES 
- TECHNICAL SPECIFICATIONS 

# Porcelain Tiles Concrete & Resin Look



INDEX



A COMPLETE  
PRODUCT  
SYSTEM



PRODUCT  
FINDER



SURFACE  
RANGE



PORCELAIN TILES  
WALL TILES

COMPANY



COLLECTIONS



LARGE SIZES



SLABS FOR  
COUNTERTOPS  
& FURNITURE



SINKS &  
BATHROOM  
FURNISHING





FACADES



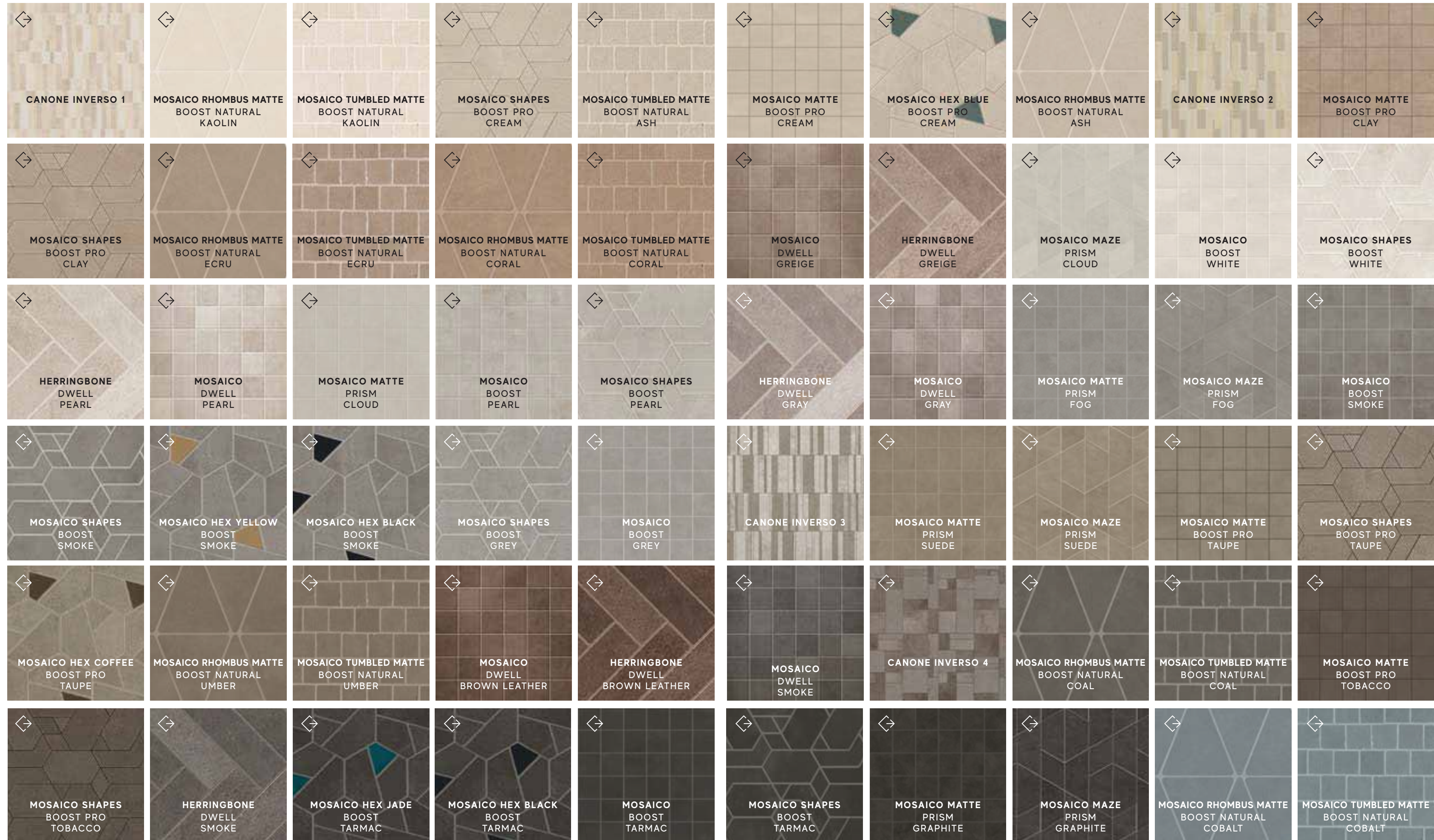

TECHNICAL  
SPECIFICATIONS





INDEX 

A COMPLETE PRODUCT SYSTEM 

PRODUCT FINDER 

**SURFACE RANGE** 

PORCELAIN TILES  
WALL TILES

COMPANY 

COLLECTIONS 

LARGE SIZES 

SLABS FOR COUNTERTOPS & FURNITURE 

SINKS & BATHROOM FURNISHING 

FACADES 

TECHNICAL SPECIFICATIONS 





# Porcelain Tiles Metal Look

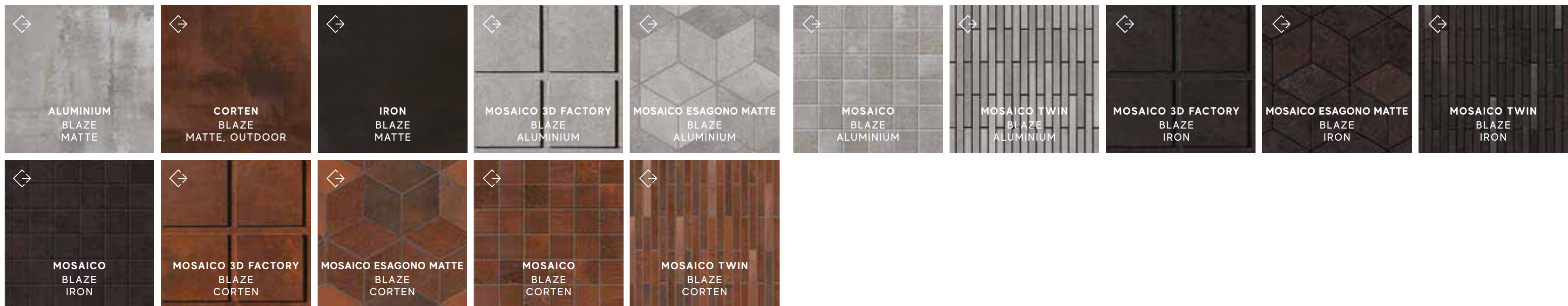

INDEX



A COMPLETE PRODUCT SYSTEM



PRODUCT FINDER



SURFACE RANGE



PORCELAIN TILES  
WALL TILES

COMPANY



COLLECTIONS



LARGE SIZES



SLABS FOR COUNTERTOPS & FURNITURE



SINKS & BATHROOM FURNISHING



FACADES



TECHNICAL SPECIFICATIONS



# Porcelain Tiles Marble Look

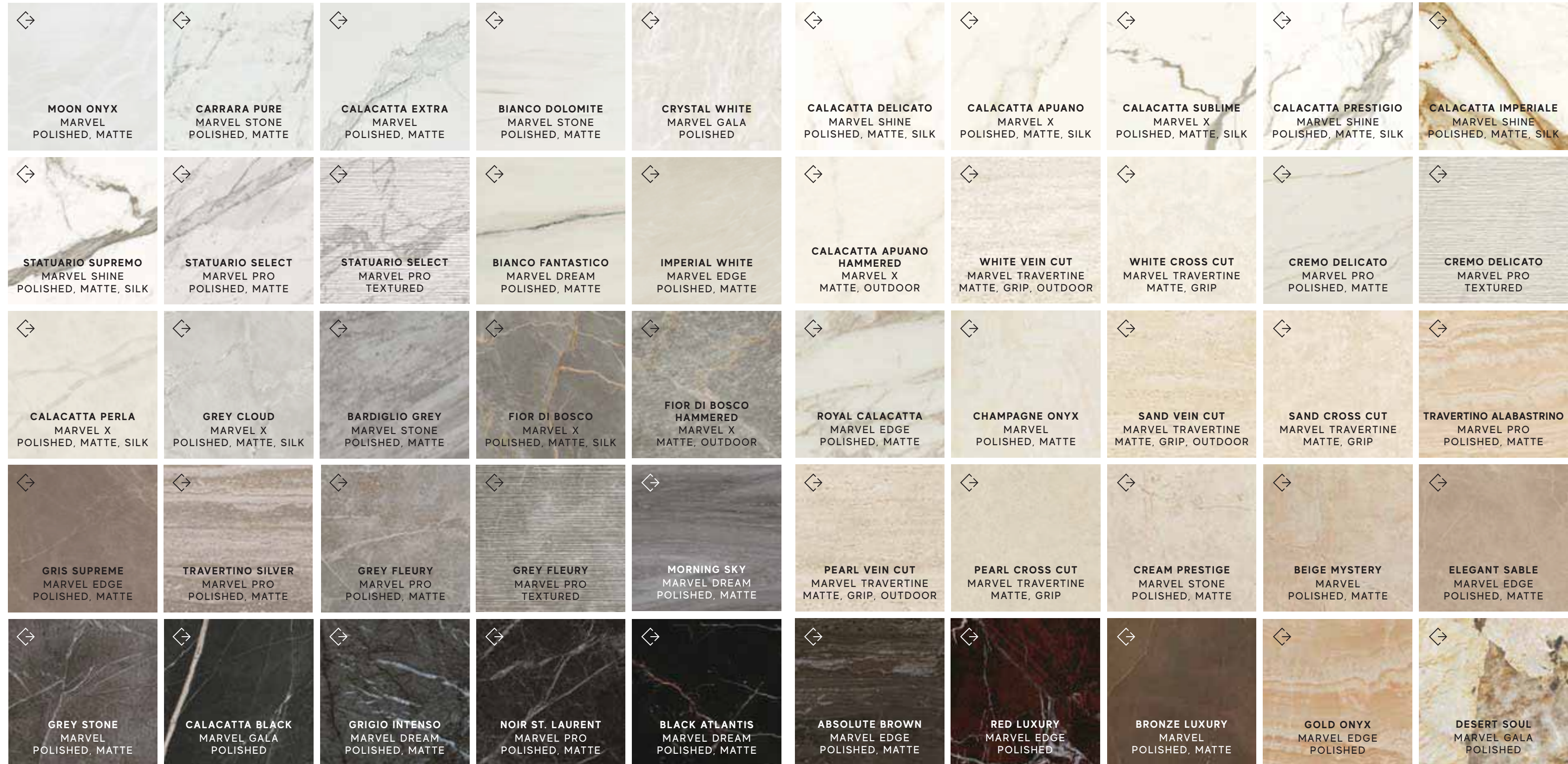

INDEX



A COMPLETE  
PRODUCT  
SYSTEM



PRODUCT  
FINDER



SURFACE  
RANGE



PORCELAIN TILES  
WALL TILES

COMPANY



COLLECTIONS



LARGE SIZES



SLABS FOR  
COUNTERTOPS  
& FURNITURE



SINKS &  
BATHROOM  
FURNISHING



FACADES



TECHNICAL  
SPECIFICATIONS



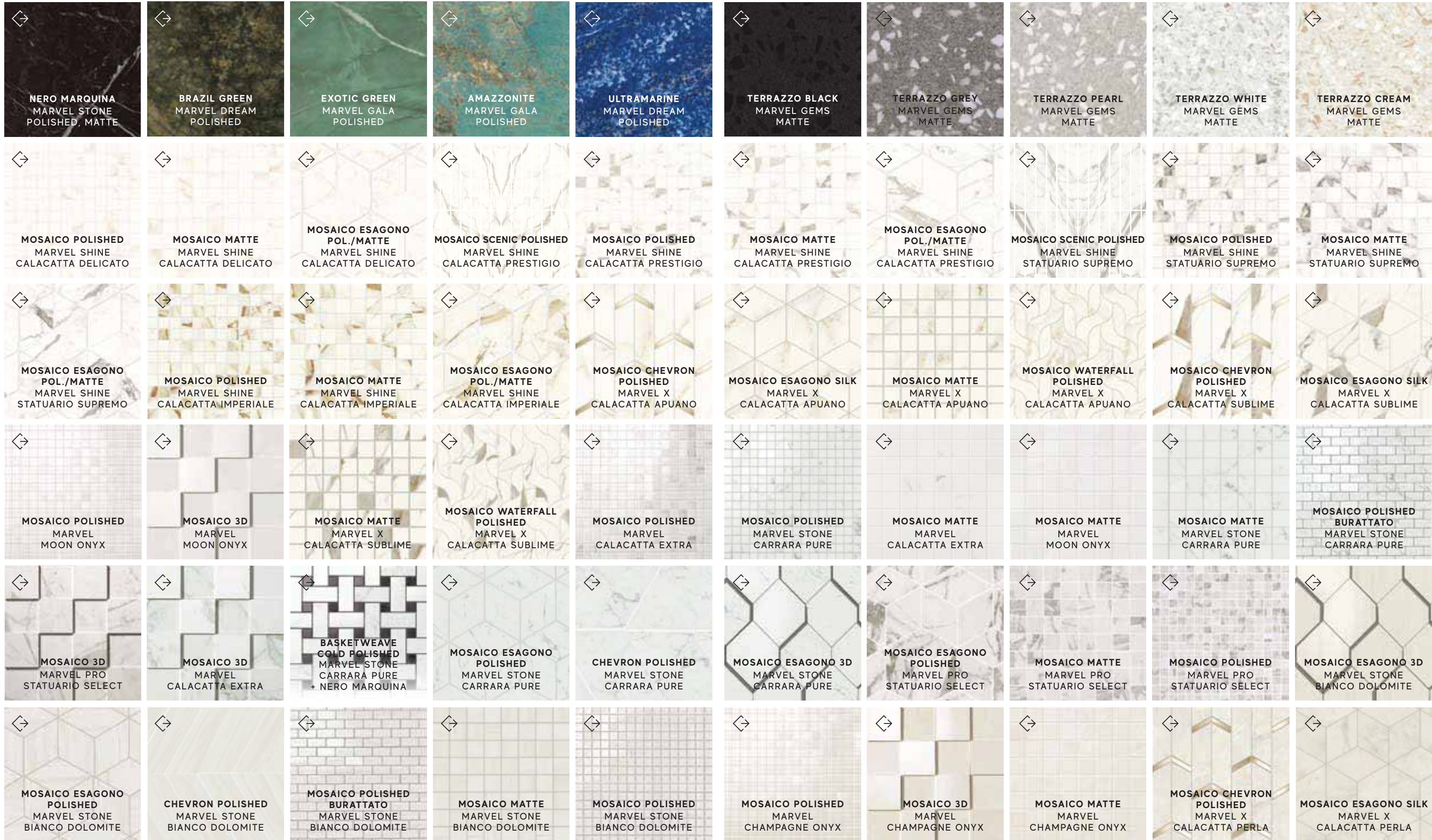

INDEX



A COMPLETE  
PRODUCT  
SYSTEM



PRODUCT  
FINDER



SURFACE  
RANGE



PORCELAIN TILES  
WALL TILES

COMPANY



COLLECTIONS



LARGE SIZES



SLABS FOR  
COUNTERTOPS  
& FURNITURE



SINKS &  
BATHROOM  
FURNISHING



FACADES



TECHNICAL  
SPECIFICATIONS



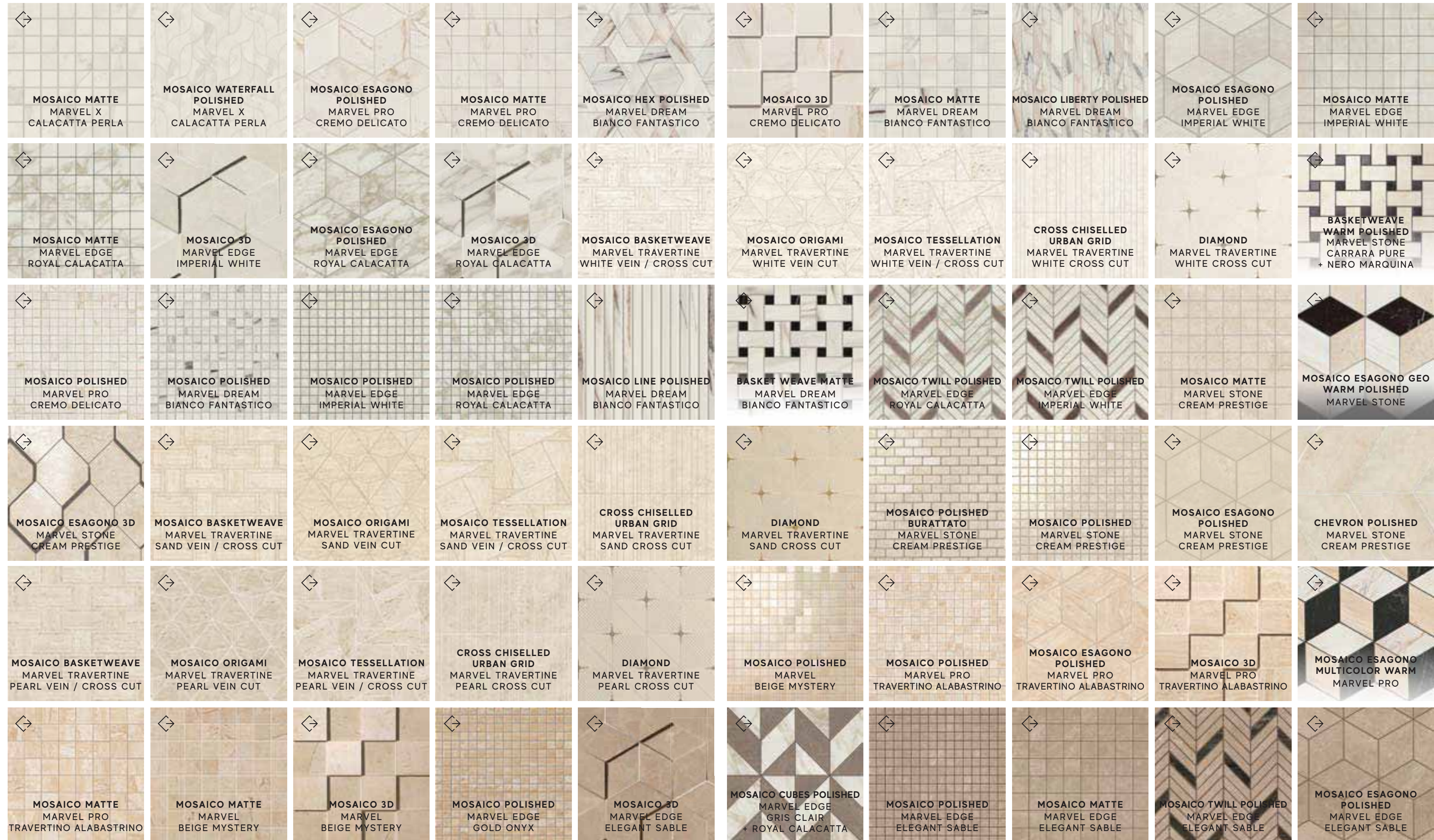

INDEX



A COMPLETE PRODUCT SYSTEM >

PRODUCT FINDER >

SURFACE RANGE >

PORCELAIN TILES  
WALL TILES

COMPANY >

COLLECTIONS >

LARGE SIZES >

SLABS FOR COUNTERTOPS & FURNITURE >

SINKS & BATHROOM FURNISHING >

FACADES >

TECHNICAL SPECIFICATIONS >

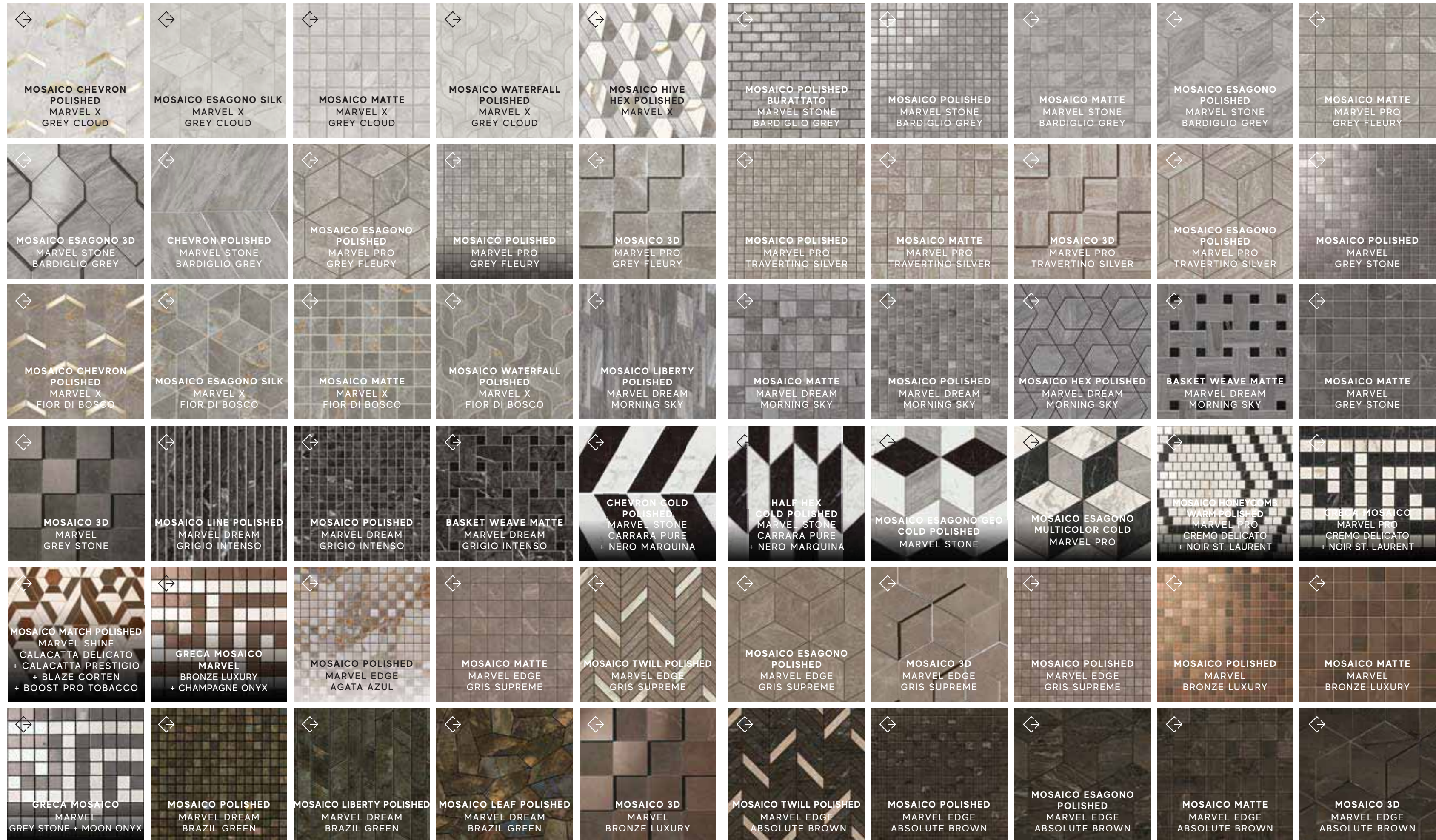

INDEX 

A COMPLETE PRODUCT SYSTEM 

PRODUCT FINDER 

**SURFACE RANGE** 

PORCELAIN TILES  
WALL TILES

COMPANY 

COLLECTIONS 

LARGE SIZES 

SLABS FOR COUNTERTOPS & FURNITURE 

SINKS & BATHROOM FURNISHING 

FACADES 

TECHNICAL SPECIFICATIONS 



INDEX



A COMPLETE  
PRODUCT  
SYSTEM



PRODUCT  
FINDER



SURFACE  
RANGE



PORCELAIN TILES  
WALL TILES

COMPANY



COLLECTIONS



LARGE SIZES



SLABS FOR  
COUNTERTOPS  
& FURNITURE



SINKS &  
BATHROOM  
FURNISHING



FACADES



TECHNICAL  
SPECIFICATIONS



# Porcelain Tiles Stone Look



INDEX



A COMPLETE  
PRODUCT  
SYSTEM



PRODUCT  
FINDER



SURFACE  
RANGE



PORCELAIN TILES  
WALL TILES

COMPANY



COLLECTIONS



LARGE SIZES



SLABS FOR  
COUNTERTOPS  
& FURNITURE



SINKS &  
BATHROOM  
FURNISHING



FACADES



TECHNICAL  
SPECIFICATIONS



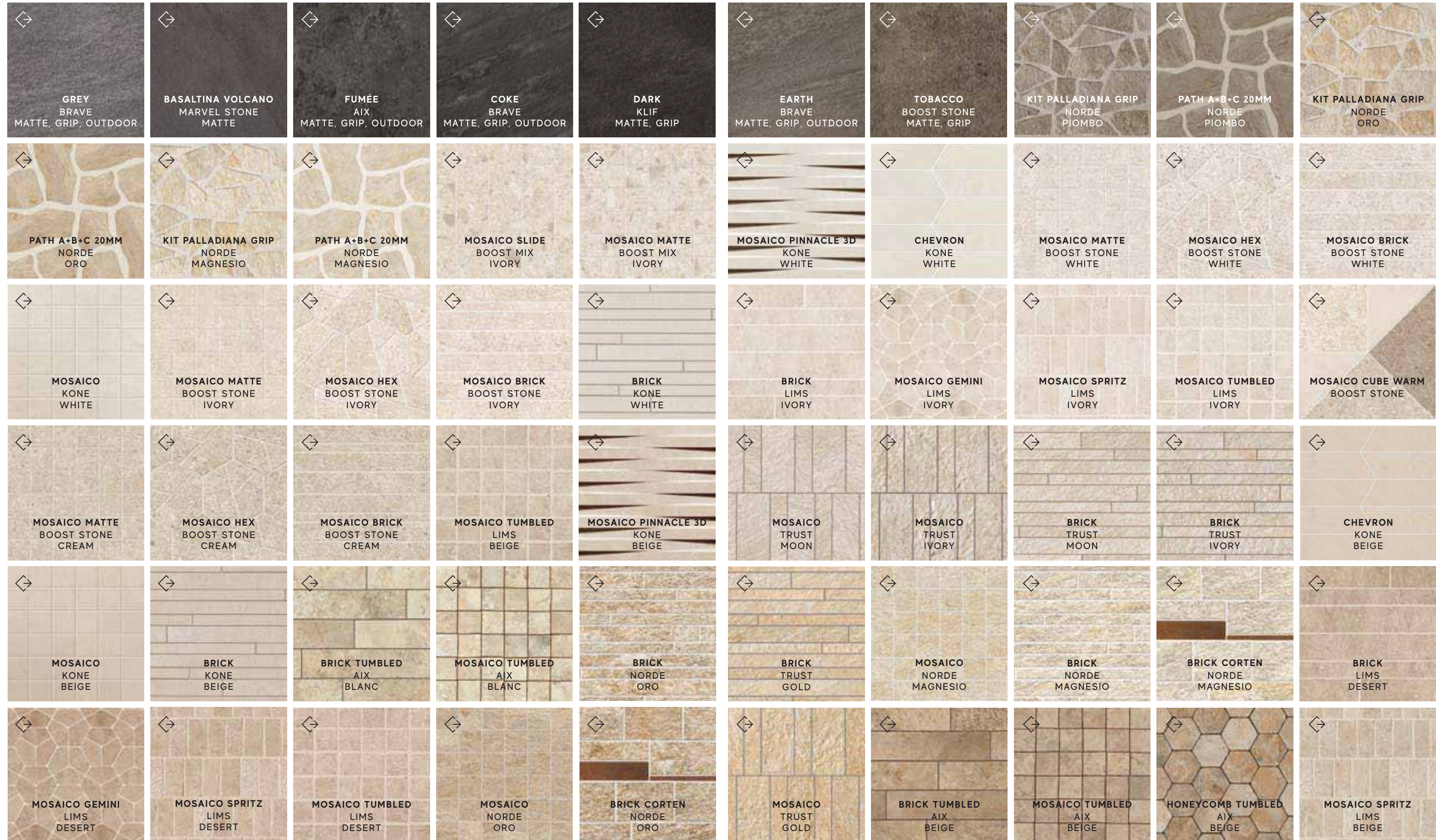

INDEX



A COMPLETE PRODUCT SYSTEM



PRODUCT FINDER



SURFACE RANGE



PORCELAIN TILES  
WALL TILES

COMPANY



COLLECTIONS



LARGE SIZES



SLABS FOR COUNTERTOPS & FURNITURE



SINKS & BATHROOM FURNISHING



FACADES



TECHNICAL SPECIFICATIONS







INDEX



A COMPLETE PRODUCT SYSTEM



PRODUCT FINDER



SURFACE RANGE



PORCELAIN TILES  
WALL TILES

COMPANY



COLLECTIONS



LARGE SIZES



SLABS FOR COUNTERTOPS & FURNITURE



SINKS & BATHROOM FURNISHING





FACADES



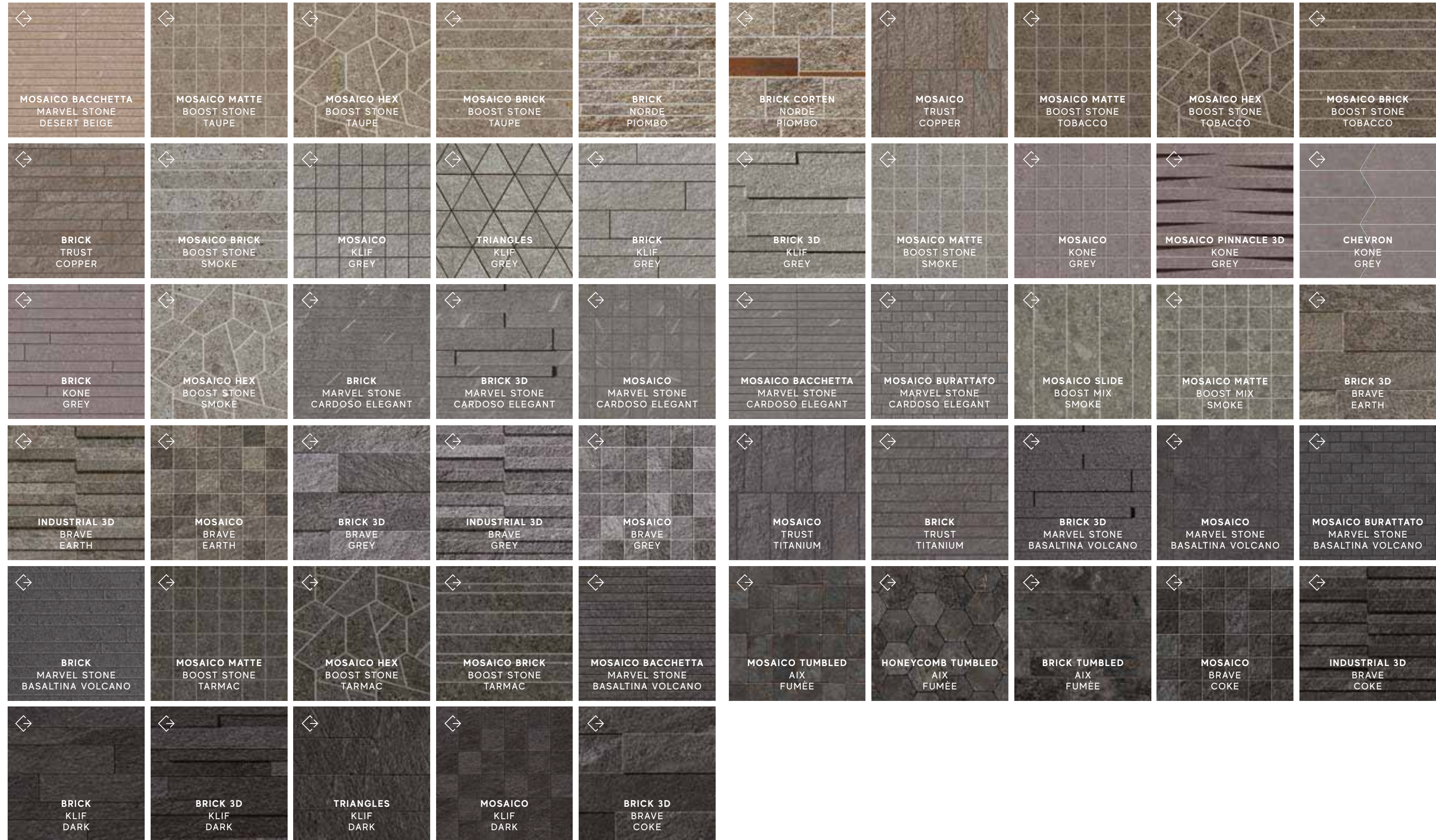

TECHNICAL SPECIFICATIONS





INDEX 

A COMPLETE PRODUCT SYSTEM 

PRODUCT FINDER 

**SURFACE RANGE** 

PORCELAIN TILES  
WALL TILES

COMPANY 

COLLECTIONS 

LARGE SIZES 

SLABS FOR COUNTERTOPS & FURNITURE 

SINKS & BATHROOM FURNISHING 

FACADES 

TECHNICAL SPECIFICATIONS 

# Porcelain Tiles Wood Look

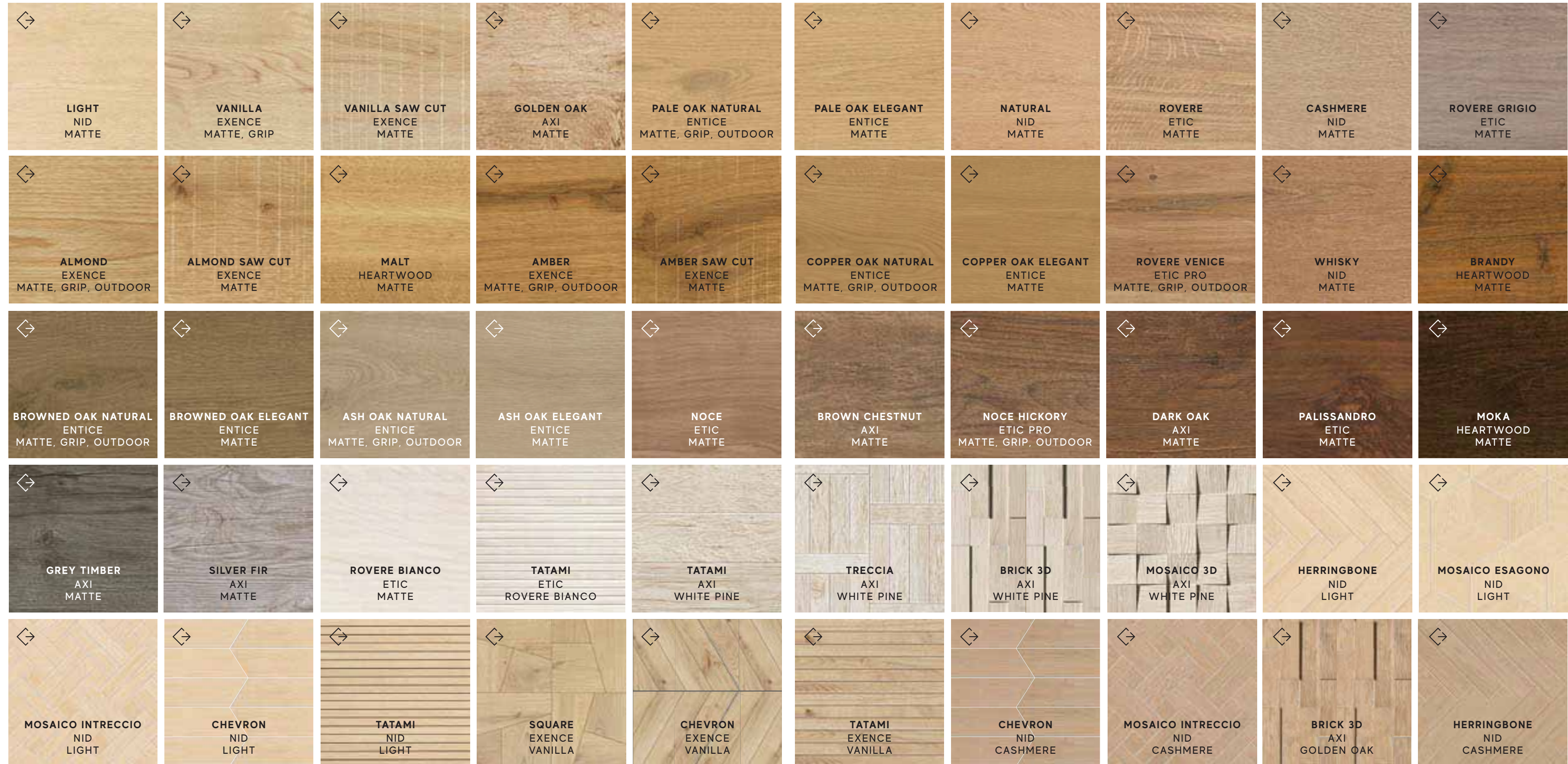

INDEX 

A COMPLETE PRODUCT SYSTEM 

PRODUCT FINDER 

**SURFACE RANGE** 

PORCELAIN TILES  
WALL TILES

COMPANY 

COLLECTIONS 













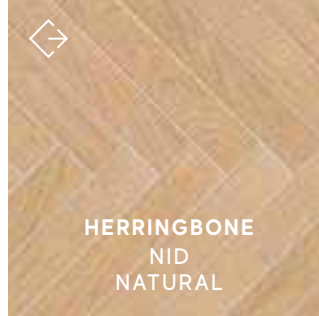

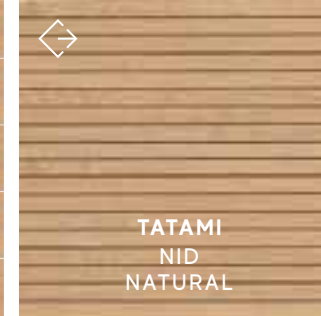

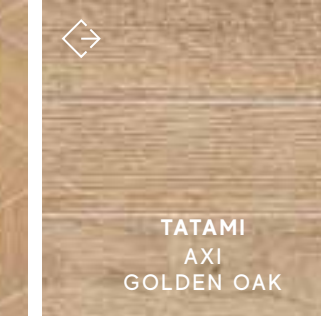
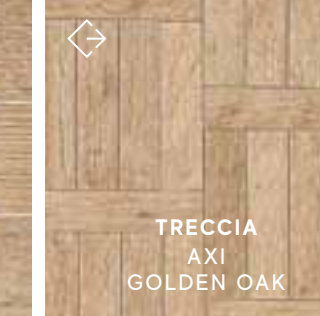
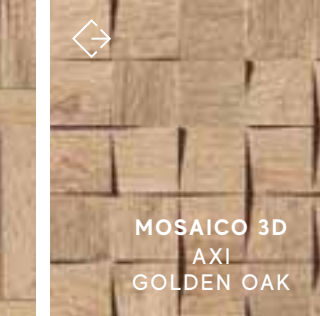

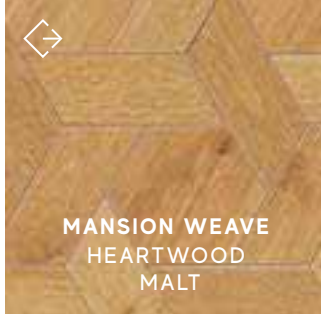
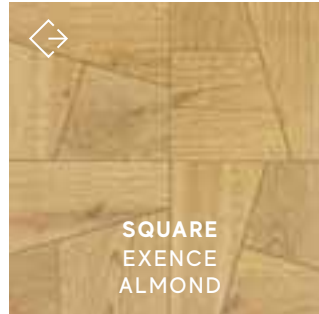
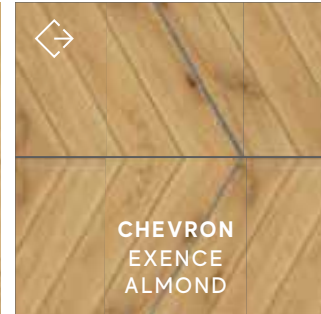
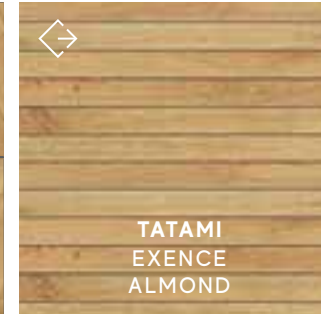
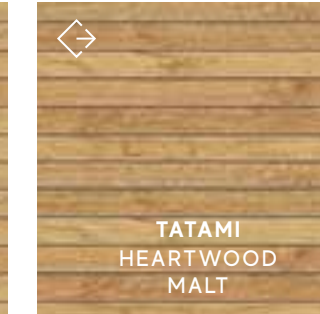
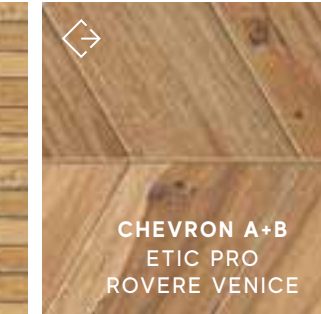
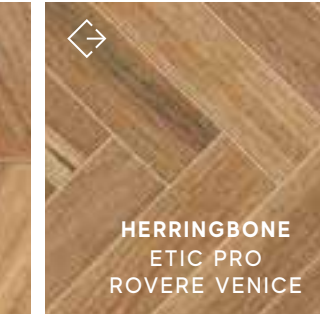

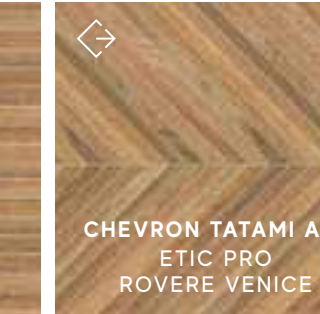

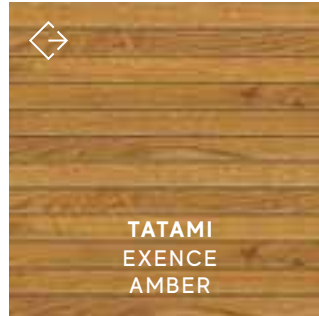
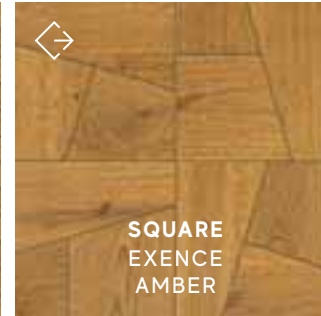
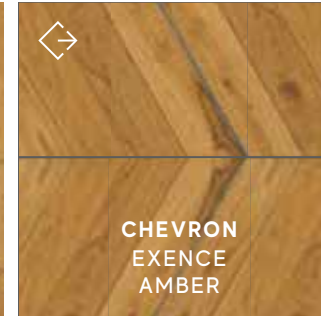

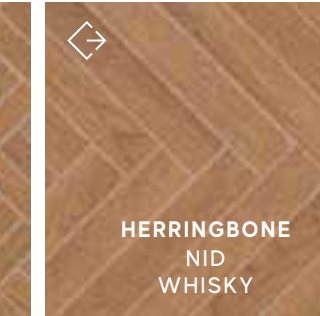

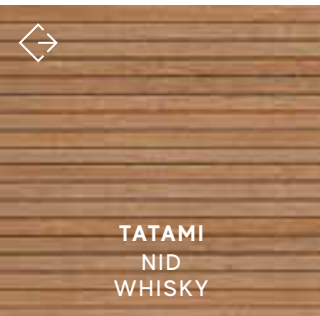
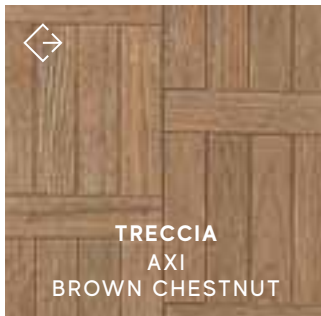
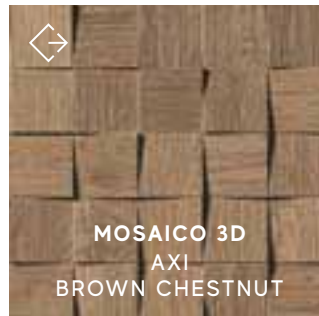
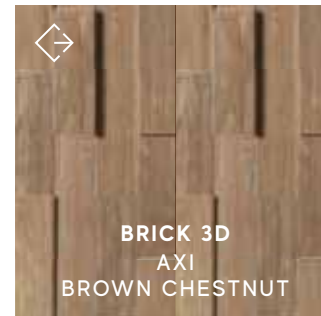

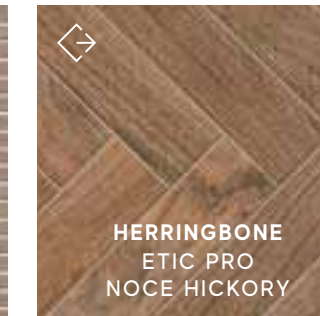
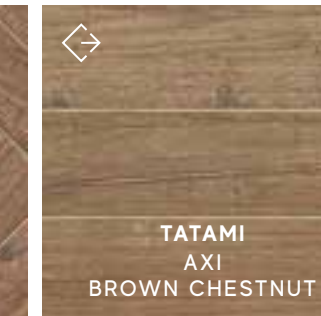
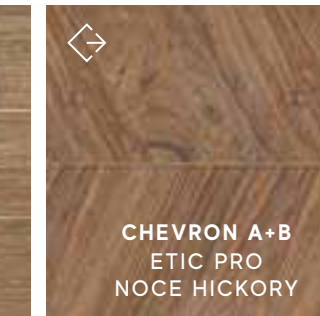
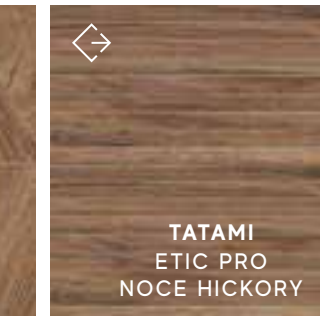
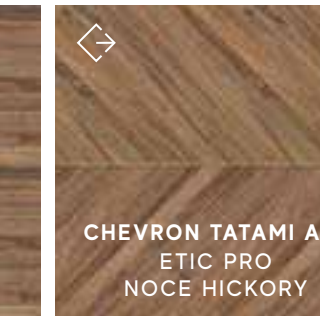
LARGE SIZES 

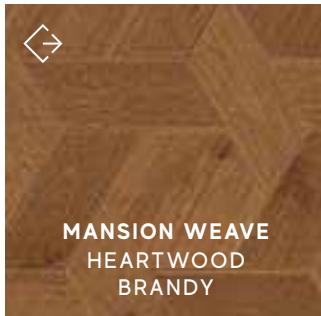
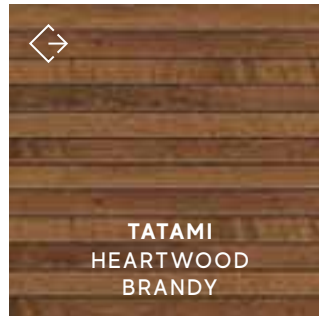
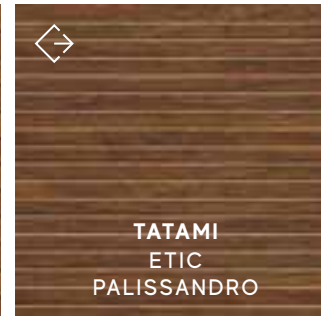
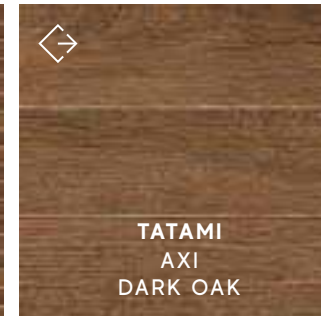
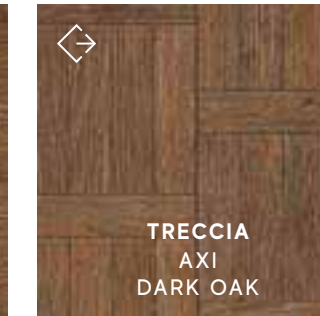
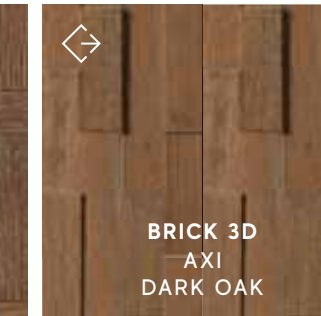
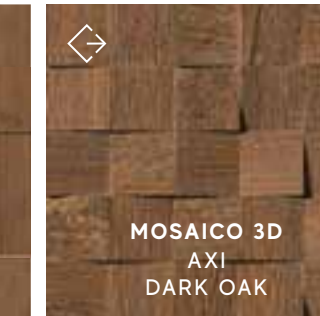
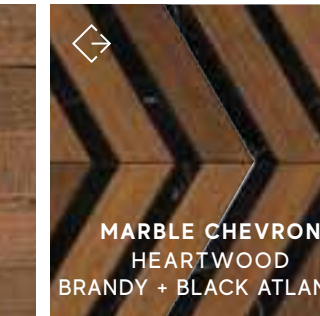
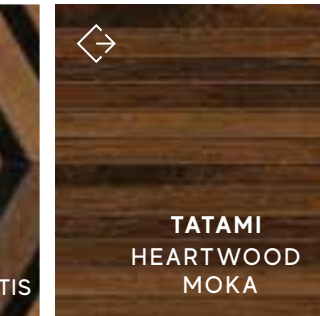
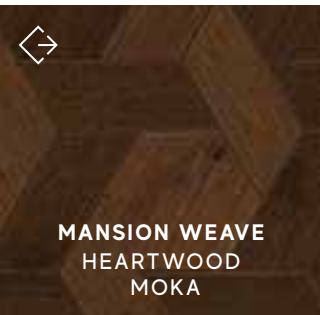
SLABS FOR COUNTERTOPS & FURNITURE 

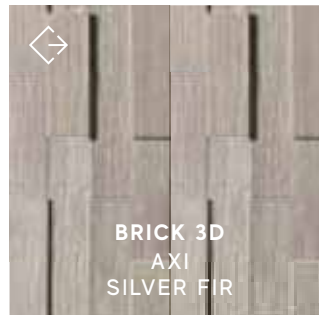
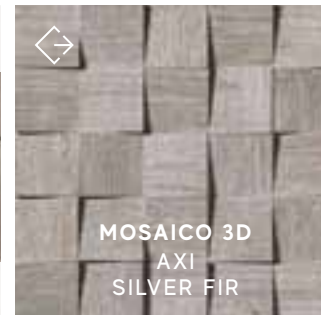
SINKS & BATHROOM FURNISHING 

FACADES 

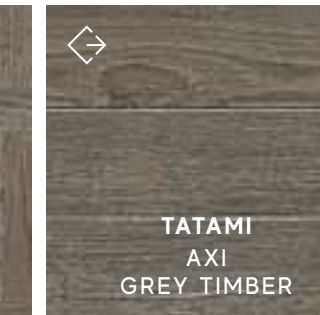
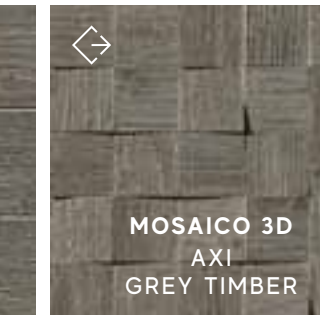
TECHNICAL SPECIFICATIONS 

 MOSAICO ESAGONO NID CASHMERE	 MOSAICO INTRECCIO NID NATURAL	 HERRINGBONE NID NATURAL	 CHEVRON NID NATURAL	 TATAMI NID NATURAL	 MOSAICO ESAGONO NID NATURAL	 TATAMI AXI GOLDEN OAK	 TRECCIA AXI GOLDEN OAK	 MOSAICO 3D AXI GOLDEN OAK	 TATAMI NID CASHMERE
 TATAMI ETIC ROVERE	 MANSION WEAVE HEARTWOOD MALT	 SQUARE EXENCE ALMOND	 CHEVRON EXENCE ALMOND	 TATAMI EXENCE ALMOND	 TATAMI HEARTWOOD MALT	 CHEVRON A+B ETIC PRO ROVERE VENICE	 HERRINGBONE ETIC PRO ROVERE VENICE	 TATAMI ETIC PRO ROVERE VENICE	 CHEVRON TATAMI A+B ETIC PRO ROVERE VENICE
 INDUSTRIAL 3D ETIC PRO ROVERE VENICE	 MARBLE CHEVRON HEARTWOOD MALT + BLACK ATLANTIS	 TATAMI EXENCE AMBER	 SQUARE EXENCE AMBER	 CHEVRON EXENCE AMBER	 TATAMI ETIC NOCE	 MOSAICO INTRECCIO NID WHISKY	 HERRINGBONE NID WHISKY	 MOSAICO ESAGONO NID WHISKY	 CHEVRON NID WHISKY
 TATAMI NID WHISKY	 TRECCIA AXI BROWN CHESTNUT	 MOSAICO 3D AXI BROWN CHESTNUT	 BRICK 3D AXI BROWN CHESTNUT	 TATAMI ETIC ROVERE GRIGIO	 HERRINGBONE ETIC PRO NOCE HICKORY	 TATAMI AXI BROWN CHESTNUT	 CHEVRON A+B ETIC PRO NOCE HICKORY	 TATAMI ETIC PRO NOCE HICKORY	 CHEVRON TATAMI A+B ETIC PRO NOCE HICKORY
 INDUSTRIAL 3D ETIC PRO NOCE HICKORY	 MANSION WEAVE HEARTWOOD BRANDY	 TATAMI HEARTWOOD BRANDY	 TATAMI ETIC PALISSANDRO	 TATAMI AXI DARK OAK	 TRECCIA AXI DARK OAK	 BRICK 3D AXI DARK OAK	 MOSAICO 3D AXI DARK OAK	 MARBLE CHEVRON HEARTWOOD BRANDY + BLACK ATLANTIS	 TATAMI HEARTWOOD MOKA
 MANSION WEAVE HEARTWOOD MOKA	 MARBLE CHEVRON HEARTWOOD MOKA + BLACK ATLANTIS	 BRICK 3D AXI SILVER FIR	 MOSAICO 3D AXI SILVER FIR	 TATAMI AXI SILVER FIR	 TRECCIA AXI SILVER FIR	 TRECCIA AXI GREY TIMBER	 TATAMI AXI GREY TIMBER	 MOSAICO 3D AXI GREY TIMBER	 BRICK 3D AXI GREY TIMBER

INDEX



A COMPLETE  
PRODUCT  
SYSTEM



PRODUCT  
FINDER



SURFACE  
RANGE



PORCELAIN TILES  
WALL TILES

COMPANY



COLLECTIONS



LARGE SIZES



SLABS FOR  
COUNTERTOPS  
& FURNITURE



SINKS &  
BATHROOM  
FURNISHING



FACADES



TECHNICAL  
SPECIFICATIONS



# Wall Tiles

## 3D Wall



INDEX



A COMPLETE  
PRODUCT  
SYSTEM



PRODUCT  
FINDER



SURFACE  
RANGE



PORCELAIN TILES  
WALL TILES

COMPANY



COLLECTIONS



LARGE SIZES



SLABS FOR  
COUNTERTOPS  
& FURNITURE



SINKS &  
BATHROOM  
FURNISHING



FACADES



TECHNICAL  
SPECIFICATIONS





# Wall Tiles Stone Look



INDEX



A COMPLETE  
PRODUCT  
SYSTEM



PRODUCT  
FINDER



SURFACE  
RANGE



PORCELAIN TILES  
WALL TILES

COMPANY



COLLECTIONS



LARGE SIZES



SLABS FOR  
COUNTERTOPS  
& FURNITURE



SINKS &  
BATHROOM  
FURNISHING



FACADES



TECHNICAL  
SPECIFICATIONS



# Wall Tiles Concrete Look

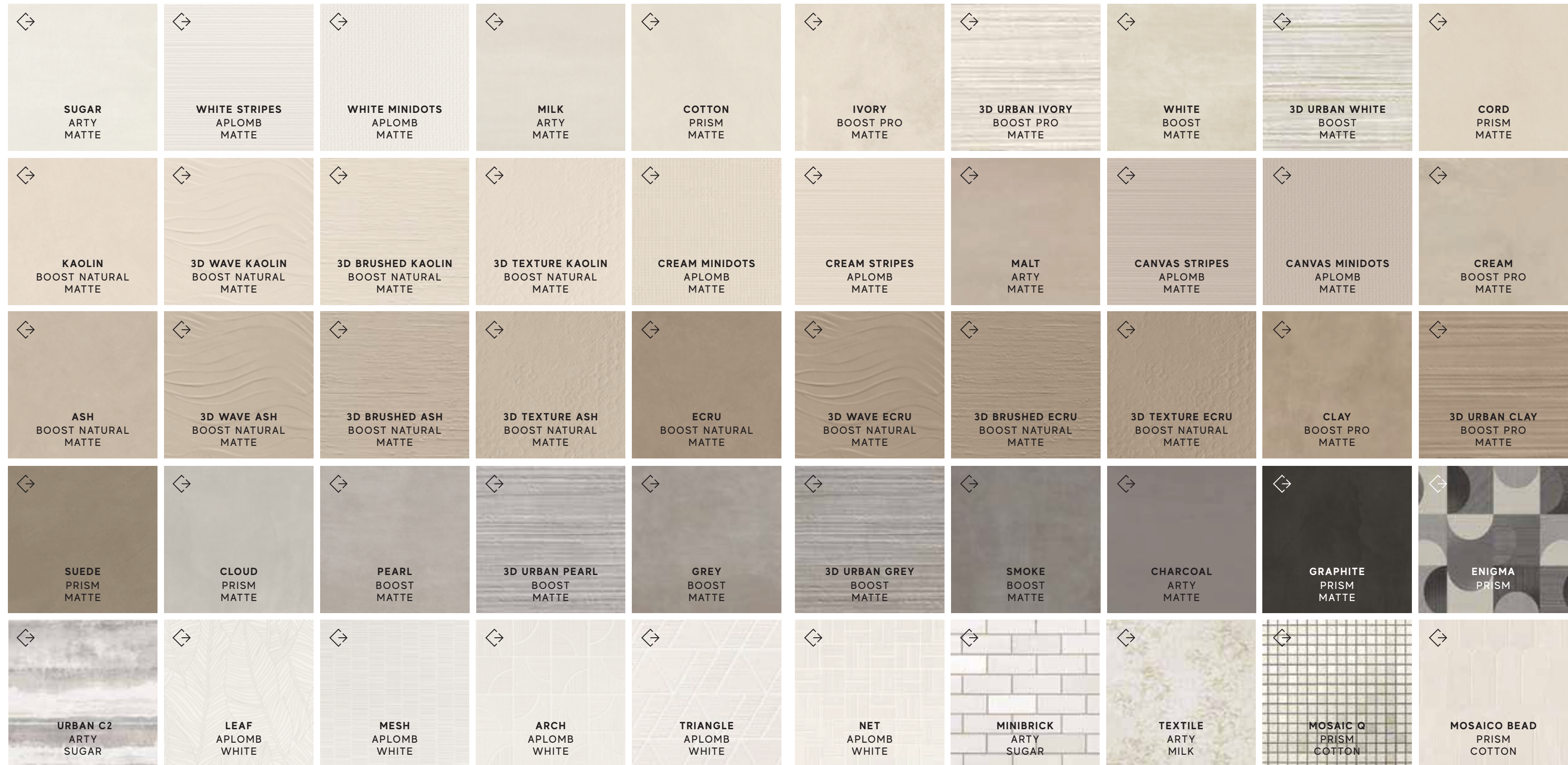

INDEX



A COMPLETE PRODUCT SYSTEM >

PRODUCT FINDER >

**SURFACE RANGE** >

PORCELAIN TILES  
WALL TILES

COMPANY >

COLLECTIONS >

LARGE SIZES >

SLABS FOR COUNTERTOPS & FURNITURE >

SINKS & BATHROOM FURNISHING >

FACADES >

TECHNICAL SPECIFICATIONS >

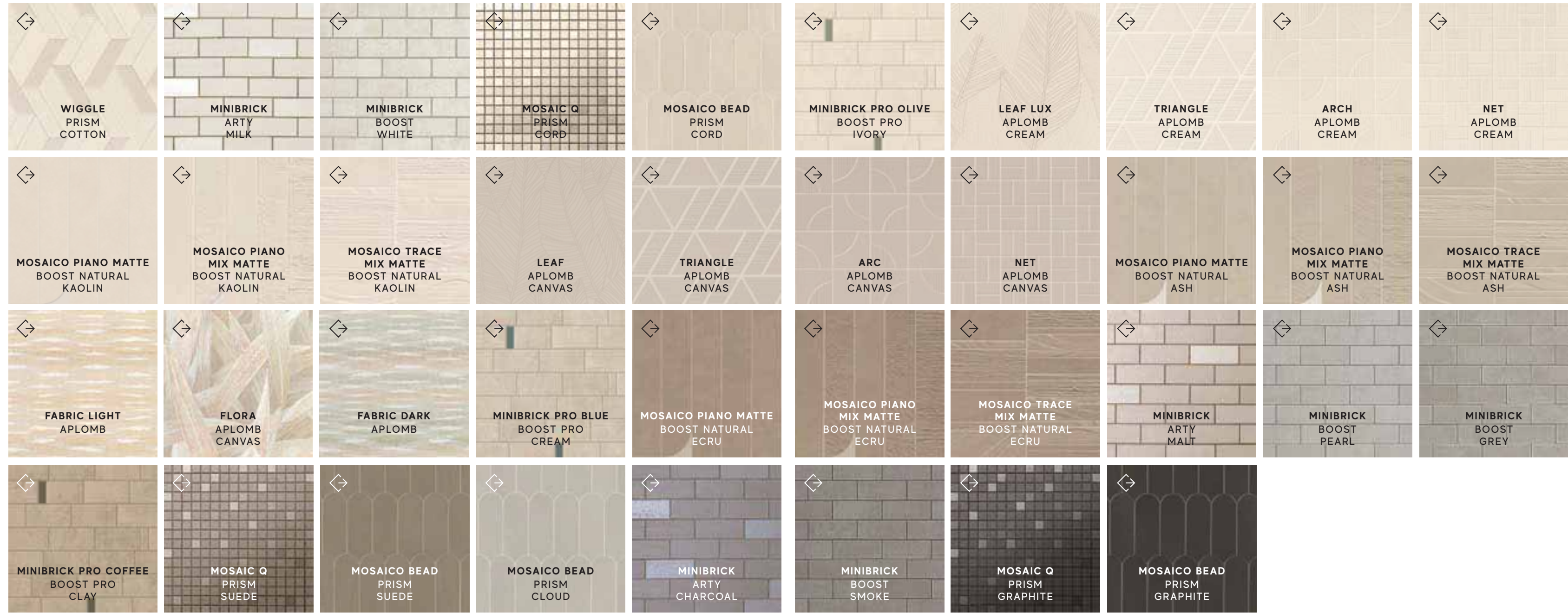

INDEX 

A COMPLETE PRODUCT SYSTEM 

PRODUCT FINDER 

**SURFACE RANGE**   
PORCELAIN TILES  
WALL TILES

COMPANY 

COLLECTIONS 

LARGE SIZES 

SLABS FOR COUNTERTOPS & FURNITURE 

SINKS & BATHROOM FURNISHING 

FACADES 

TECHNICAL SPECIFICATIONS 



# Wall Tiles Marble Look

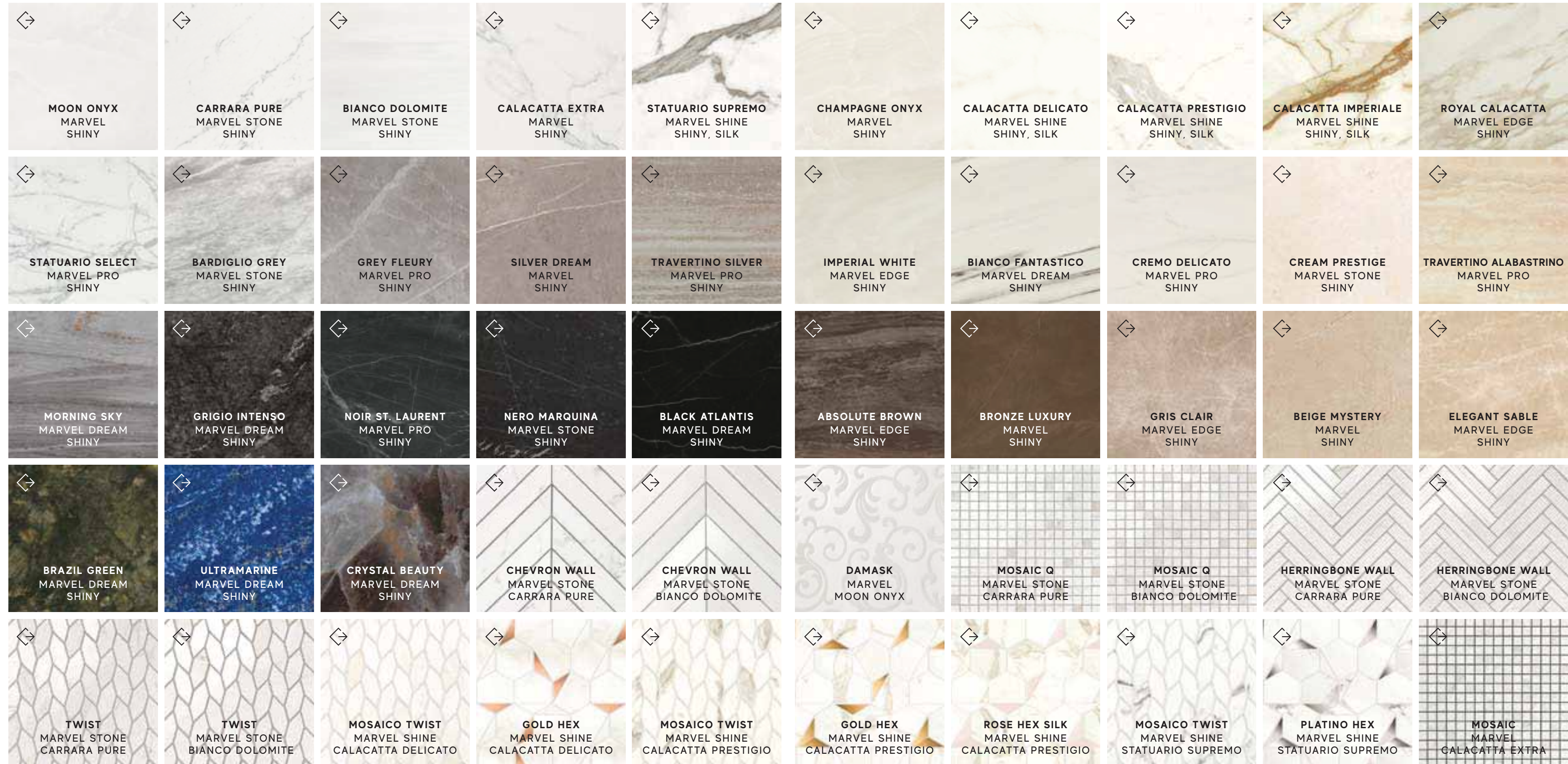

INDEX



A COMPLETE PRODUCT SYSTEM >

PRODUCT FINDER >

**SURFACE RANGE** >

PORCELAIN TILES  
WALL TILES

COMPANY >

COLLECTIONS >

LARGE SIZES >

SLABS FOR COUNTERTOPS & FURNITURE >

SINKS & BATHROOM FURNISHING >

FACADES >

TECHNICAL SPECIFICATIONS >

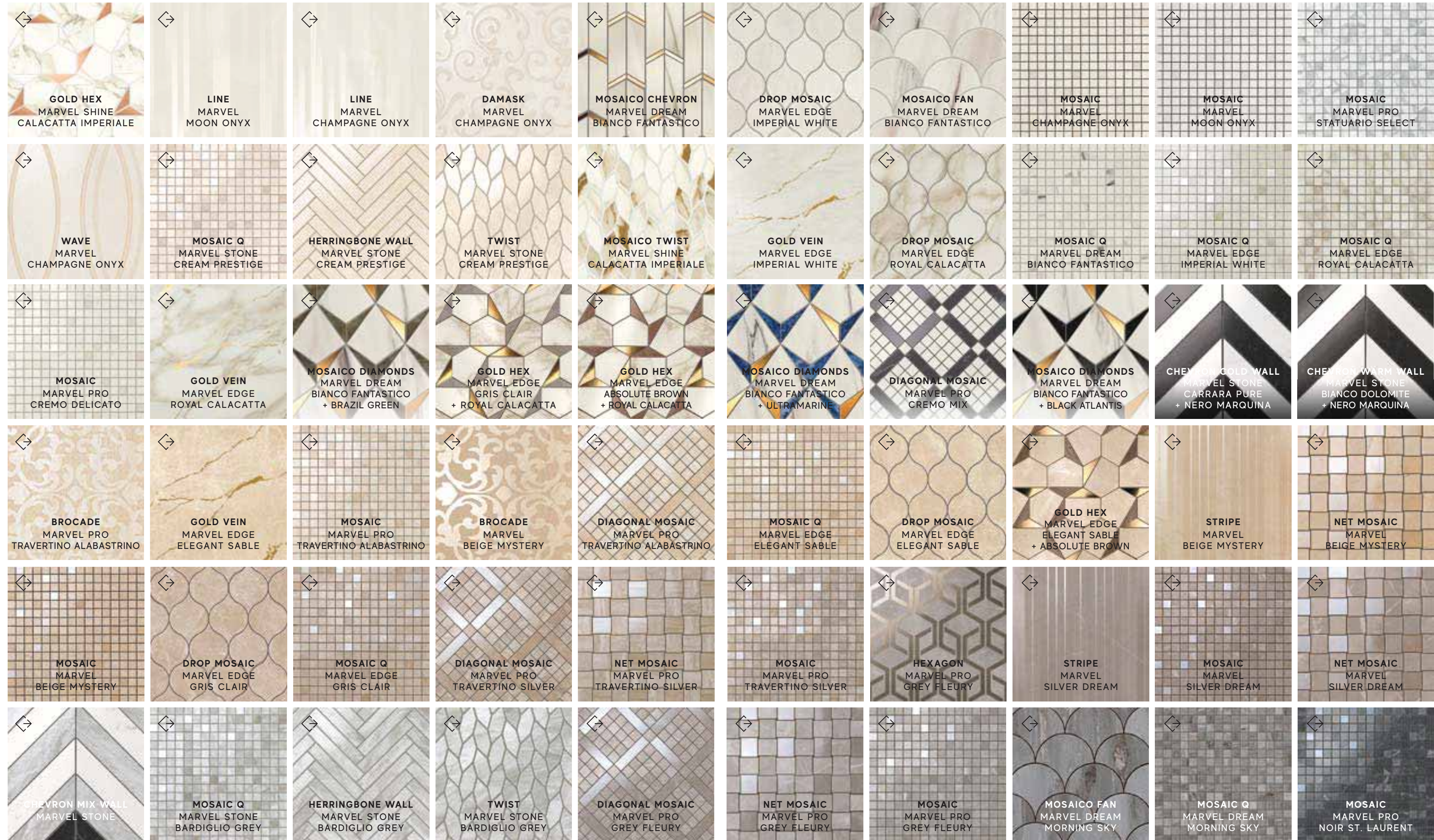

INDEX 

A COMPLETE PRODUCT SYSTEM 

PRODUCT FINDER 

**SURFACE RANGE**   
PORCELAIN TILES  
WALL TILES

COMPANY 

COLLECTIONS 

LARGE SIZES 

SLABS FOR COUNTERTOPS & FURNITURE 

SINKS & BATHROOM FURNISHING 

FACADES 

TECHNICAL SPECIFICATIONS 

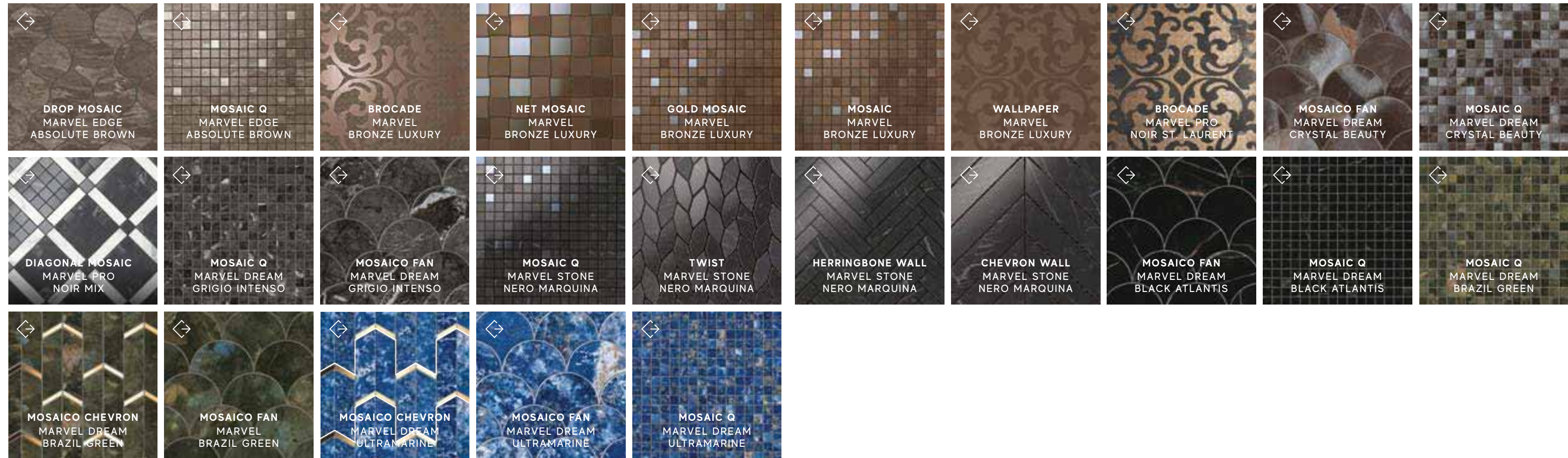

INDEX



A COMPLETE  
PRODUCT  
SYSTEM



PRODUCT  
FINDER



**SURFACE  
RANGE**



PORCELAIN TILES  
WALL TILES

COMPANY



COLLECTIONS



LARGE SIZES



SLABS FOR  
COUNTERTOPS  
& FURNITURE



SINKS &  
BATHROOM  
FURNISHING



FACADES



TECHNICAL  
SPECIFICATIONS



# Wall Tiles Color Look

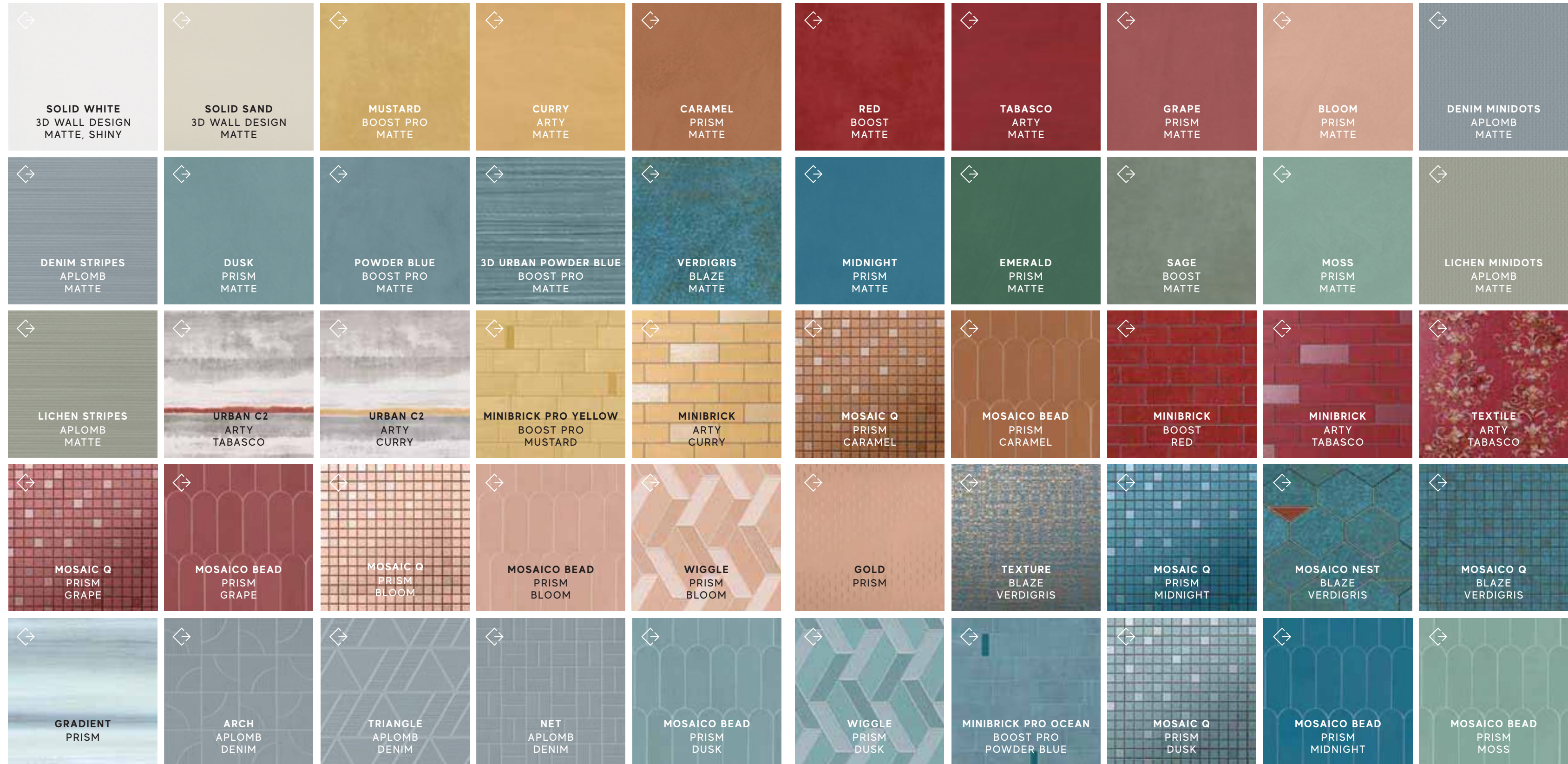

INDEX



A COMPLETE  
PRODUCT  
SYSTEM



PRODUCT  
FINDER



SURFACE  
RANGE



PORCELAIN TILES  
WALL TILES

COMPANY



COLLECTIONS



LARGE SIZES



SLABS FOR  
COUNTERTOPS  
& FURNITURE



SINKS &  
BATHROOM  
FURNISHING



FACADES



TECHNICAL  
SPECIFICATIONS



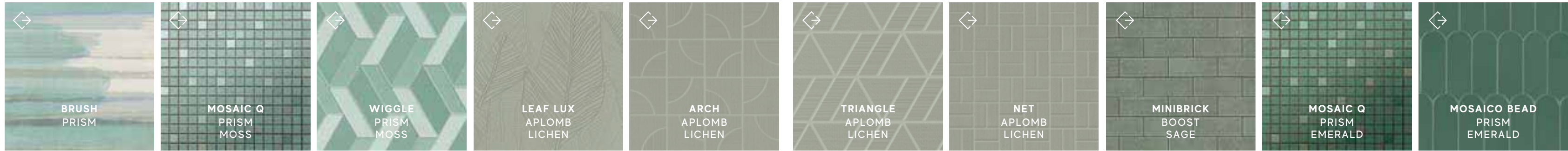

# Wall Tiles Metal Look

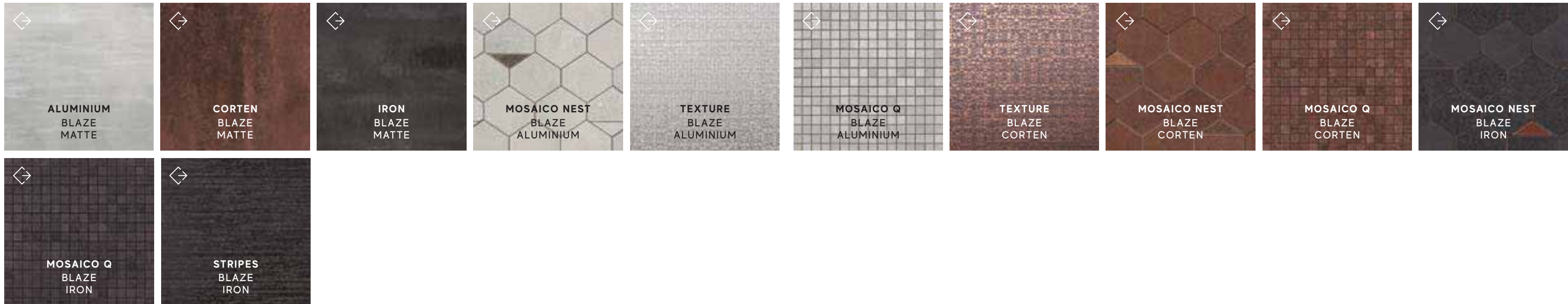

INDEX



A COMPLETE PRODUCT SYSTEM



PRODUCT FINDER



SURFACE RANGE



PORCELAIN TILES  
WALL TILES

COMPANY



COLLECTIONS



LARGE SIZES



SLABS FOR COUNTERTOPS & FURNITURE



SINKS & BATHROOM FURNISHING



FACADES



TECHNICAL SPECIFICATIONS



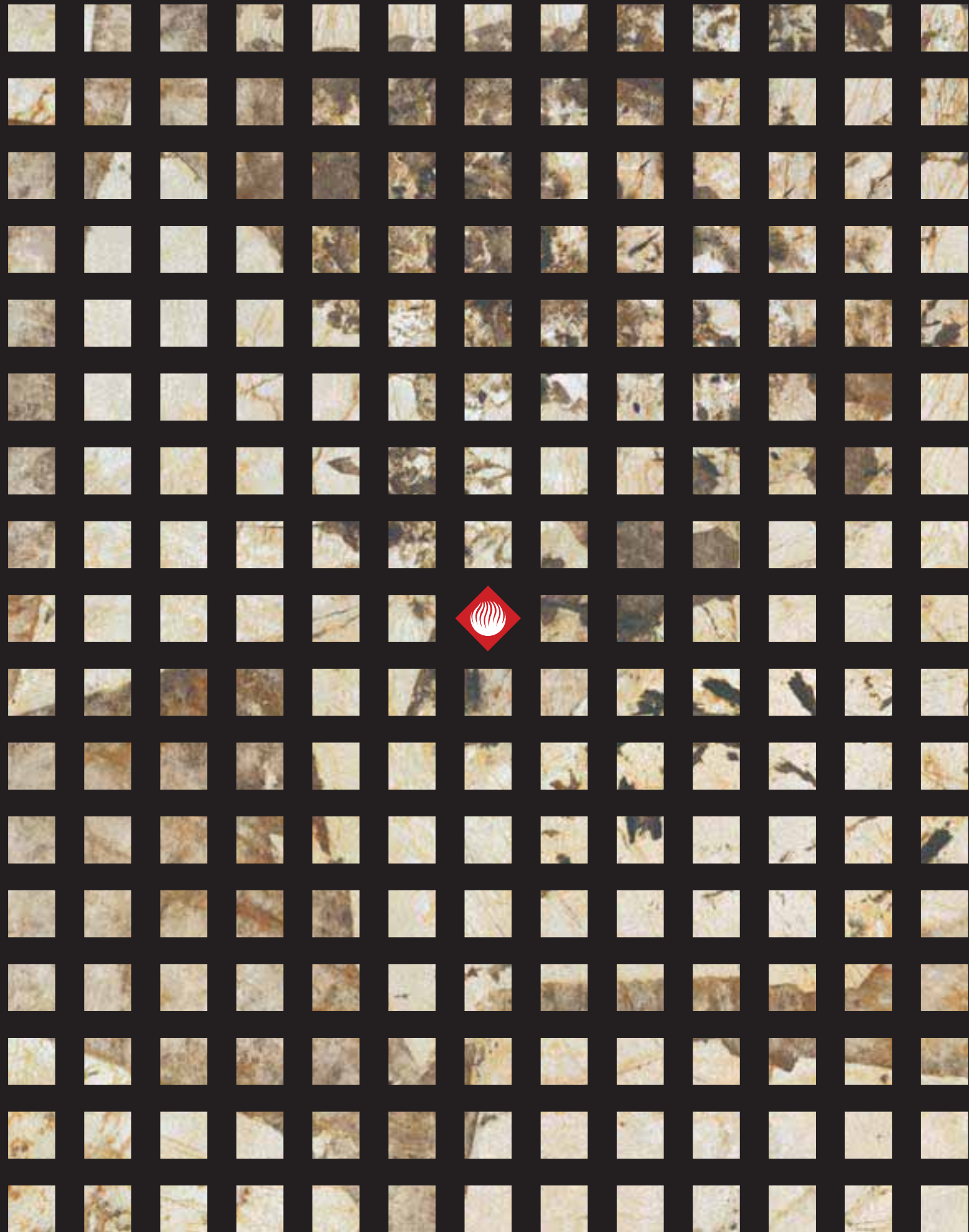

# Company

- ↔ HISTORY
- ↔ HEADQUARTERS
- ↔ SHOWROOMS
- ↔ INTERNATIONAL LEADERSHIP
- ↔ WORLDWIDE PROJECTS
- ↔ A COMPLETE RANGE
- ↔ DESIGN
- ↔ SUSTAINABILITY
- ↔ ENVIRONMENT
- ↔ CERTIFICATIONS
- ↔ PEOPLE
- ↔ ETHICAL IDENTITY
- ↔ A SAFE CHOICE

INDEX



A COMPLETE  
PRODUCT  
SYSTEM



PRODUCT  
FINDER



SURFACE  
RANGE



COMPANY



COLLECTIONS



LARGE SIZES



SLABS FOR  
COUNTERTOPS  
& FURNITURE



SINKS &  
BATHROOM  
FURNISHING



FACADES



TECHNICAL  
SPECIFICATIONS



# History

From 1969 to the present. Growth on solid pillars: innovation, technology, research.



© Ceramiche Atlas Concorde



© Ceramiche Atlas Concorde

Historical photos from 1969

Atlas Concorde, progenitor of the Concorde Group, is one of the leading global brands in the production of ceramic surfaces, with a strong vocation for design and architecture.

Atlas Concorde, capostipite del Gruppo Concorde, è uno dei principali brand mondiali nella produzione di superfici ceramiche, con una spiccata vocazione al design e all'architettura.

Atlas Concorde, société mère du groupe Concorde, est l'une des principales marques mondiales dans le domaine de la fabrication de surfaces céramiques, avec un accent particulier sur le design et l'architecture.

Atlas Concorde, Stammhaus eines der weltweit wichtigsten Hersteller von Keramikbelägen, zeichnet sich durch eine klare Berufung zum Design und zur Architektur aus.

Atlas Concorde, empresa matriz del Grupo Concorde, es una de las marcas líderes en la producción de superficies cerámicas a nivel mundial, con una fuerte vocación por el diseño y la arquitectura.

Компания Atlas Concorde, родоначальница группы Concorde, является одним из ведущих мировых производителей плитки и создателем незаурядных решений для архитектуры и дизайна.



© Ceramiche Atlas Concorde

INDEX



A COMPLETE PRODUCT SYSTEM >

PRODUCT FINDER >

SURFACE RANGE >

COMPANY >

COLLECTIONS >

LARGE SIZES >

SLABS FOR COUNTERTOPS & FURNITURE >

SINKS & BATHROOM FURNISHING >

FACADES >

TECHNICAL SPECIFICATIONS >



© Ceramiche Atlas Concorde

# Headquarters

A unique multifunctional area.



© Ceramiche Atlas Concorde

**The headquarters**  
Offices designed by the architect Tiziano Lugli



© Ceramiche Atlas Concorde

**The outdoor pavilion**  
A multifunctional space surrounded by greenery, designed by the architect Guglielmo Renzi

— **Villa Casino Vicini and its park**  
An elegant lodging facility with restaurant and sports and recreational facilities in a centuries-old park

INDEX



A COMPLETE PRODUCT SYSTEM >

PRODUCT FINDER >

SURFACE RANGE >

COMPANY >

COLLECTIONS >

LARGE SIZES >

SLABS FOR COUNTERTOPS & FURNITURE >

SINKS & BATHROOM FURNISHING >

FACADES >

TECHNICAL SPECIFICATIONS >



# Showrooms

Our spaces in the most important capitals of design:  
Milan, Dubai, Lyon, Moscow, London.



© Ceramiche Atlas Concorde

**Atlas Concorde Studio Milano**  
Brera Design District



© Ceramiche Atlas Concorde

**Atlas Concorde London Studio**  
Clerkenwell Design District

**Atlas Concorde Headquarter Showroom** —  
Fiorano Modenese



© Ceramiche Atlas Concorde

INDEX



A COMPLETE  
PRODUCT  
SYSTEM >

PRODUCT  
FINDER >

SURFACE  
RANGE >

COMPANY >

COLLECTIONS >

LARGE SIZES >

SLABS FOR  
COUNTERTOPS  
& FURNITURE >

SINKS &  
BATHROOM  
FURNISHING >

FACADES >

TECHNICAL  
SPECIFICATIONS >

# International leadership

A widespread presence around the world.

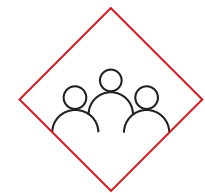

OVER  
**4000**  
CUSTOMERS

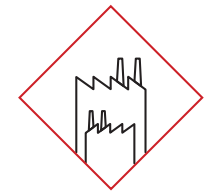

**4**  
PRODUCTION FACILITIES

FRANKLIN, USA  
FINALE EMILIA, ITALY  
FIORANO MODENESE, ITALY  
MOSCOW, RUSSIA

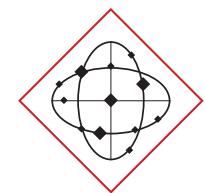

ACTIVE IN  
**5**  
CONTINENTS

**130**  
COUNTRIES

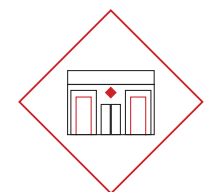

**7**  
SHOWROOMS

FRANKLIN, USA  
LONDON, UK  
LYON, FRANCE  
MILANO, ITALY  
FIORANO MODENESE, ITALY  
MOSCOW, RUSSIA  
DUBAI, UAE

**16**  
COMMERCIAL OFFICES

FRANKLIN, USA - DANIA BEACH, USA  
LYON, FRANCE - PARIS, FRANCE - LONDON, UK  
MILANO, ITALY - FIORANO MODENESE, ITALY  
PRAGUE, CZECH REPUBLIC - KIEV, UKRAINA  
RIGA, LATVIA - BUDAPEST, HUNGARY  
SAINT PETERSBURG, RUSSIA - MOSCOW, RUSSIA  
DUBAI, UAE - SEOUL, SOUTH KOREA - SYDNEY, AUSTRALIA

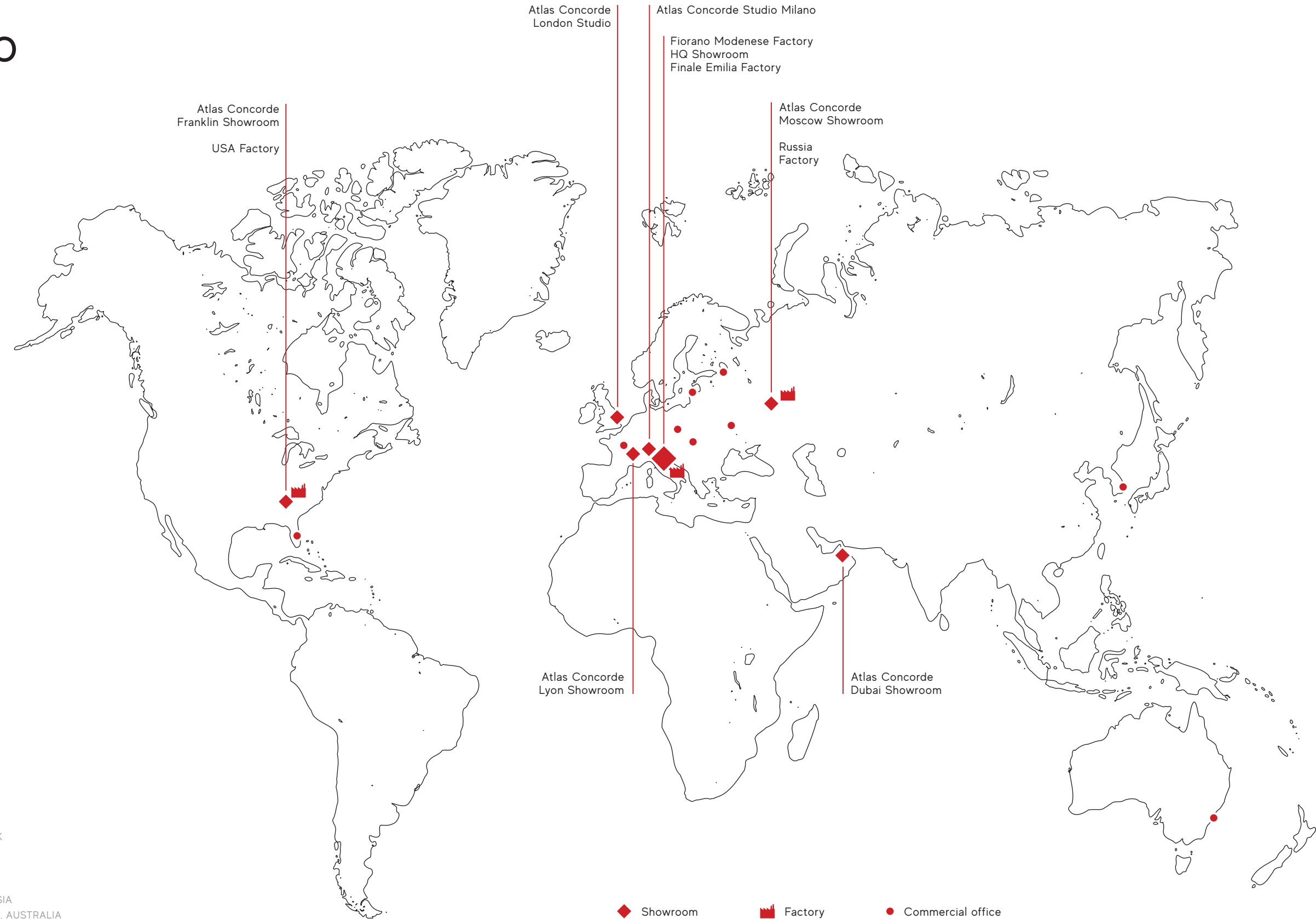

A COMPLETE PRODUCT SYSTEM >

PRODUCT FINDER >

SURFACE RANGE >

COMPANY >

COLLECTIONS >

LARGE SIZES >

SLABS FOR COUNTERTOPS & FURNITURE >

SINKS & BATHROOM FURNISHING >

FACADES >

TECHNICAL SPECIFICATIONS >

# Worldwide projects

A selection of projects featuring our surfaces.



INDEX 

A COMPLETE PRODUCT SYSTEM 

PRODUCT FINDER 

SURFACE RANGE 

COMPANY 

COLLECTIONS 

LARGE SIZES 

SLABS FOR COUNTERTOPS & FURNITURE 

SINKS & BATHROOM FURNISHING 

FACADES 

TECHNICAL SPECIFICATIONS 



© Ceramiche Atlas Concorde

# A complete range

The result of passion, know-how, and maximum industrial efficiency.

## PRODUCTION

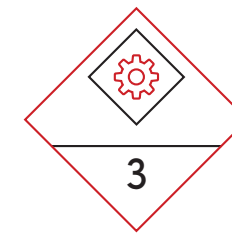

PORCELAIN TILES  
WALL TILES  
LARGE SLABS

## COLLECTIONS

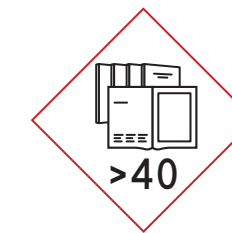

AN AVERAGE OF  
**5** NEW LAUNCHES  
EACH YEAR

## SIZES



26 SIZES  
**LARGE SLABS**  
6 SIZES

## FINISHES

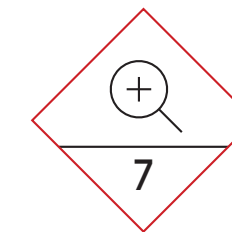

MATTE  
MATTE SENSITECH  
SATIN  
SILK  
POLISHED  
GRIP  
OUTDOOR

## TECHNOLOGIES

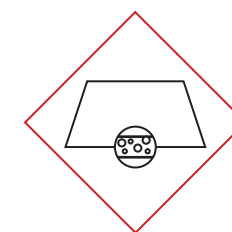

**Sensitech**  
**NATURA-VEIN™**  
TECH  
**NATURA-BODY™**  
TECH

## LOOKS

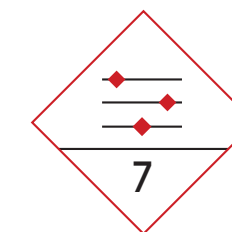

3D WALL  
CONCRETE & RESIN  
MARBLE  
STONE  
WOOD  
METAL  
COLOR

INDEX



A COMPLETE  
PRODUCT  
SYSTEM



PRODUCT  
FINDER



SURFACE  
RANGE



COMPANY



COLLECTIONS



LARGE SIZES



SLABS FOR  
COUNTERTOPS  
& FURNITURE



SINKS &  
BATHROOM  
FURNISHING



FACADES



TECHNICAL  
SPECIFICATIONS



# With designers, for designers

Side by side with design professionals.

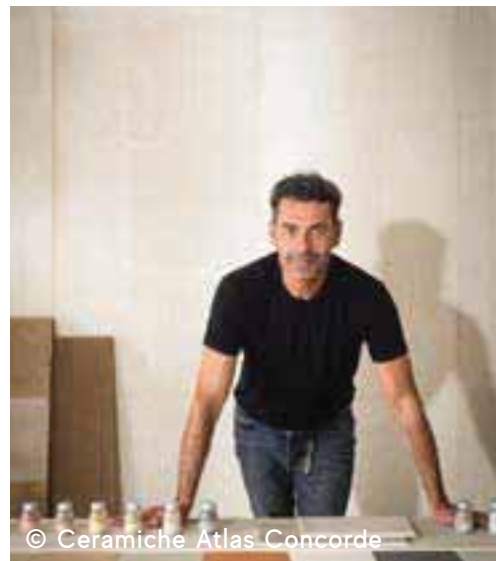

Matteo Brioni  
BOOST NATURAL 





Mario Ferrarini  
DIALOGO 



HBA (Hirsch Bedner Associates)  
MARVEL TRAVERTINE



Piero Lissoni  
CANONE INVERSO  
PRISM  
3D WALL CARVE  

© Ceramiche Atlas Concorde

Design achievements and awards.



reddot winner 2022

3D WALL CARVE  
APLOMB BOOST NATURAL  
DIALOGO



2022 3D WALL CARVE

A COMPLETE  
PRODUCT  
SYSTEM >

PRODUCT  
FINDER >

SURFACE  
RANGE >

COMPANY >

COLLECTIONS >

LARGE SIZES >

SLABS FOR  
COUNTERTOPS  
& FURNITURE >

SINKS &  
BATHROOM  
FURNISHING >

FACADES >

TECHNICAL  
SPECIFICATIONS >

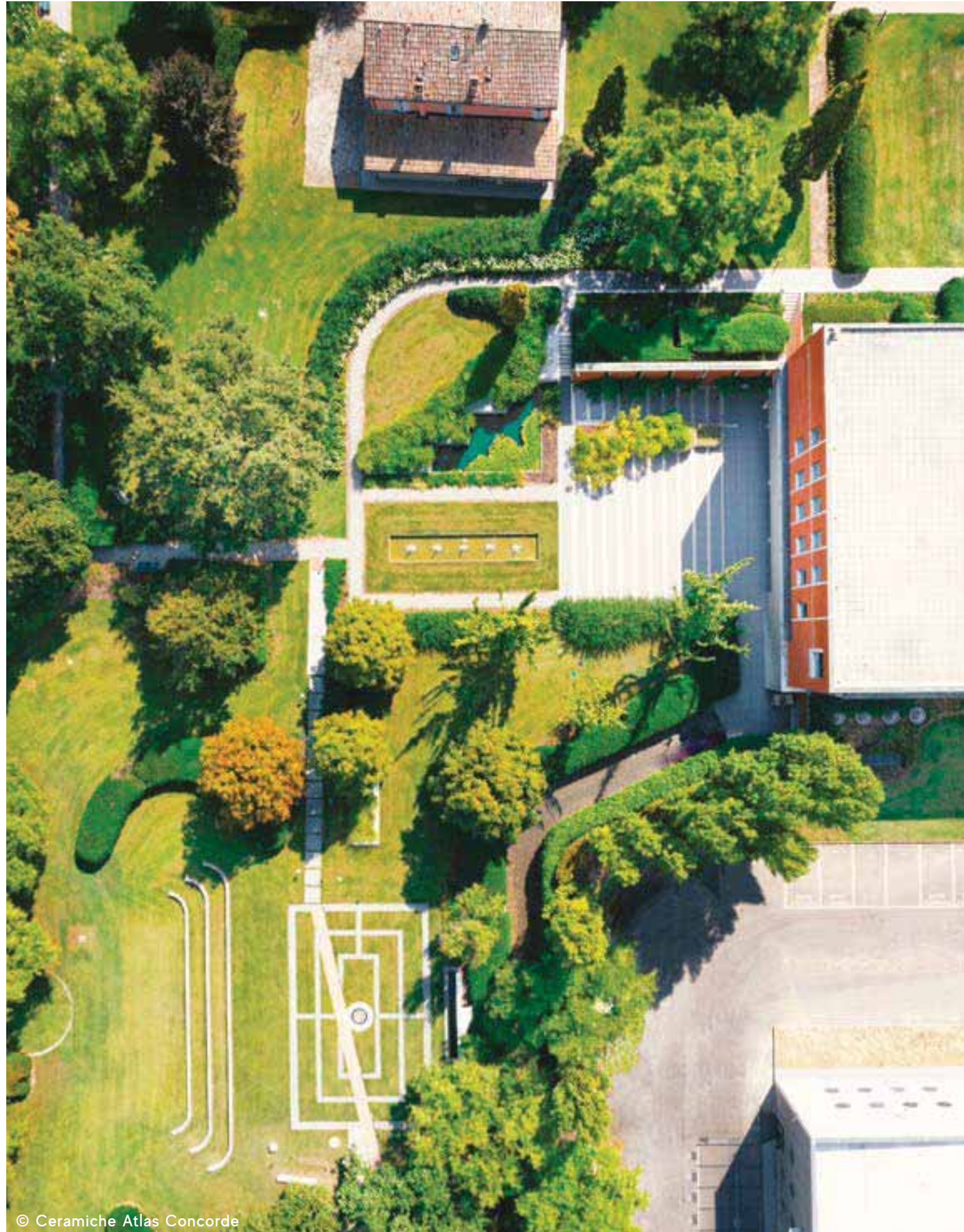

© Ceramiche Atlas Concorde

# Commitment to sustainability

Design the present, protect the future.



© Ceramiche Atlas Concorde



© Ceramiche Atlas Concorde

Sustainability is a priority, certified by leading international bodies. From energy cogeneration to resource reuse and recycling, we are constantly striving to reduce our environmental impact while maintaining production efficiency. Social responsibility is also an integral part of our business model.

La sostenibilità è una priorità, certificata dai principali enti internazionali. Dalla cogenerazione energetica, al riutilizzo e al riciclo delle risorse, ci impegniamo costantemente per ridurre l'impatto ambientale, mantenendo inalterata l'efficienza produttiva. La responsabilità sociale è inoltre parte integrante del modello imprenditoriale.

La durabilité environnementale est une priorité, certifiée par les principaux organismes internationaux. De la cogénération d'énergie, à la réutilisation et au recyclage des ressources, nous nous engageons à réduire constamment l'impact sur l'environnement tout en maintenant l'efficacité de la fabrication. La responsabilité sociale fait également partie intégrante de notre modèle d'entreprise.

Die von den wichtigsten internationalen Prüfstellen zertifizierte Nachhaltigkeit ist eine Priorität des Unternehmens. Von der Kraft-Wärme-Kopplung bis zur Wiederverwendung und zum Recycling der Ressourcen verpflichten wir uns zur kontinuierlichen Reduzierung der Umweltauswirkung bei gleichbleibend hoher Effizienz. Die soziale Verantwortung ist wesentlicher Bestandteil des unternehmerischen Modells.

La sostenibilidad es una prioridad, certificada por los principales organismos internacionales. Desde la cogeneración de energía hasta la reutilización y el reciclaje de recursos, nos esforzamos constantemente por reducir nuestro impacto ambiental manteniendo, a la vez, la eficiencia de la producción. La responsabilidad social también es parte integrante del modelo empresarial.

Экологичность нашей продукции и производства сертифицирована ведущими международными организациями. Когенерация энергии, повторное использование ресурсов, применение вторичного сырья позволяют нам снизить воздействие на окружающую среду при полном сохранении эффективности технологического процесса. Неотъемлемой составляющей нашей бизнес-модели является также социальная ответственность.

INDEX



A COMPLETE PRODUCT SYSTEM



PRODUCT FINDER



SURFACE RANGE



COMPANY



COLLECTIONS



LARGE SIZES



SLABS FOR COUNTERTOPS & FURNITURE



SINKS & BATHROOM FURNISHING



FACADES



TECHNICAL SPECIFICATIONS



# Environmental sustainability

Excellent results for a high quality product.

## Energy optimisation



Efficient methane gas cogeneration plant



Heat recovery from furnaces and cooling water



-40% CHP vapour recovery with 40% savings in methane gas



-50% 100% LED lighting, 50% annual power savings

## Waste management



100% recycled raw and cooked waste



99% waste sent to recovery



100% recycled industrial water and 27% reduction in water consumption over the last 3 years



100% recyclable packaging materials

## Environment and health



Continuously operating purification and filtration systems



RTO system to reduce harmful emissions and odours

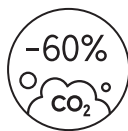

-60% Automated Vertical Warehouse: 60% reduction in CO<sub>2</sub>

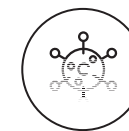

0% lead, cadmium, and other carcinogenic substances in products

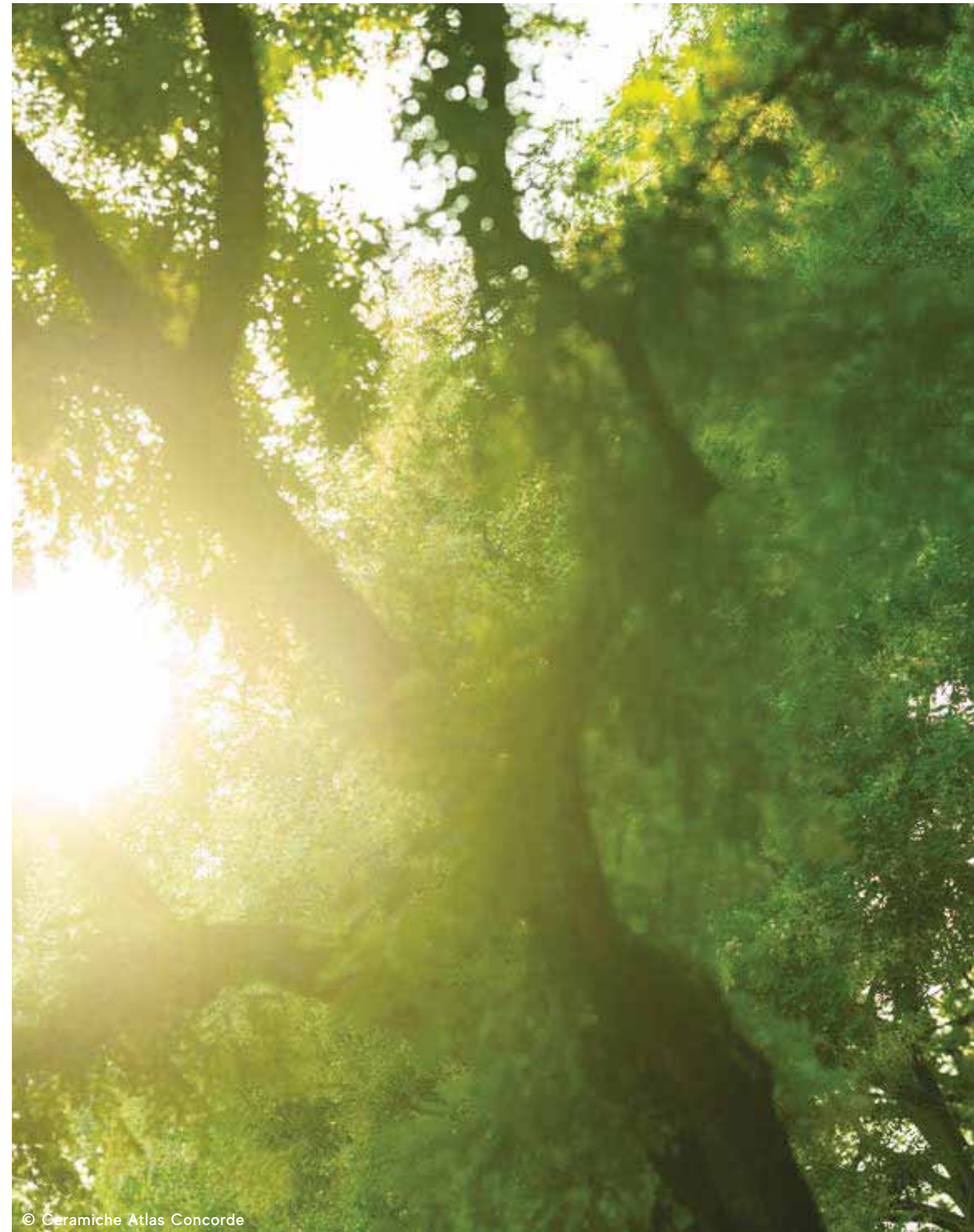

© Ceramiche Atlas Concorde

INDEX



A COMPLETE PRODUCT SYSTEM >

PRODUCT FINDER >

SURFACE RANGE >

COMPANY >

COLLECTIONS >

LARGE SIZES >

SLABS FOR COUNTERTOPS & FURNITURE >

SINKS & BATHROOM FURNISHING >

FACADES >

TECHNICAL SPECIFICATIONS >



© Ceramiche Atlas Concorde

# Certifications

The certainty of reliability, safety, and respect for the environment.

Page 448

Company certifications



Product certifications



Product declarations

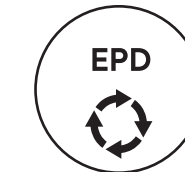

- INDEX ≡
- A COMPLETE PRODUCT SYSTEM >
- PRODUCT FINDER >
- SURFACE RANGE >
- COMPANY** >
- COLLECTIONS >
- LARGE SIZES >
- SLABS FOR COUNTERTOPS & FURNITURE >
- SINKS & BATHROOM FURNISHING >
- FACADES >
- TECHNICAL SPECIFICATIONS >



# People: our strength

Training programs, investments in safety and wellbeing at work.



© Ceramiche Atlas Concorde



© Ceramiche Atlas Concorde

**"Asilo Concorde", Concorde Kindergarden**  
A service to support our employees and the community

**The company spaces**  
Bright, designer environments to support wellbeing at work



© Ceramiche Atlas Concorde

**The people** —  
The training of our employees is a top priority

A COMPLETE PRODUCT SYSTEM >

PRODUCT FINDER >

SURFACE RANGE >

COMPANY >

COLLECTIONS >

LARGE SIZES >

SLABS FOR COUNTERTOPS & FURNITURE >

SINKS & BATHROOM FURNISHING >

FACADES >

TECHNICAL SPECIFICATIONS >



© Ceramiche Atlas Concorde

# Ethical identity

Representatives of unmistakable Italian authenticity and style.



Made in Italy isn't just style, design and excellence, it's a way of being. We identify with the values expressed by Confindustria Ceramica's ethical code, which guarantee absolute compliance with labor regulations, and with the marks Made in Italy and Ceramics of Italy, which certify the quality of authentic Italian style.

Made in Italy non è solo stile, design ed eccellenza, ma un modo di essere. Ci riconosciamo nei valori espressi dal codice etico di Confindustria Ceramica, che garantiscono il rispetto assoluto delle normative sul lavoro, e nei marchi Made in Italy e Ceramics of Italy, che certificano la qualità dell'autentico stile italiano.

Le Made in Italy n'est pas seulement un style, un design et une excellence, mais une façon d'être. Nous nous reconnaissons dans les valeurs exprimées par le code éthique de Confindustria Ceramica, qui garantit le respect absolu des règles du travail, et dans les marques Made in Italy et Ceramics of Italy, qui certifient la qualité du style italien authentique.

Made in Italy bedeutet nicht nur Stil, Design und exzellente Produkte. Es ist eine Lebenseinstellung. Wir teilen die im Ethikcode des Unternehmerverbands Confindustria Ceramica zum Ausdruck gebrachten Werte, welche die absolute Einhaltung der arbeitsrechtlichen Vorschriften garantieren, sowie jene der Marken Made in Italy und Ceramics of Italy als Garantie der Qualität des authentischen, italienischen Stils.

El Made in Italy no es sólo estilo, diseño y excelencia, sino una forma de ser. Nos reconocemos en los valores expresados por el código ético de Confindustria Ceramica, que garantizan el respeto absoluto de las leyes laborales, y en las marcas Made in Italy y Ceramics of Italy, que certifican la calidad del auténtico estilo italiano.

«Made in Italy» для нас – это не просто стиль и производственное мастерство, а образ жизни. Поэтому мы полностью разделяем ценности, закрепленные в «Этическом кодексе» федерации Confindustria Ceramica (ассоциация предприятий керамической отрасли) и предусматривающие строгое соблюдение трудового законодательства. А маркировка Made in Italy и Ceramics of Italy на нашей плитке является гарантией ее качества и аутентичного итальянского дизайна.

INDEX



A COMPLETE PRODUCT SYSTEM



PRODUCT FINDER



SURFACE RANGE



COMPANY



COLLECTIONS



LARGE SIZES



SLABS FOR COUNTERTOPS & FURNITURE



SINKS & BATHROOM FURNISHING



FACADES



TECHNICAL SPECIFICATIONS



# Porcelain and wall tiles: a safe choice

**HYGIENIC**  
Igienico

**RECYCLABLE**  
Riciclabile

**VERSATILE**  
Versatile

**SAFE**  
Sicuro

**FIREPROOF**  
Non brucia

**EASY TO CLEAN  
AND DISINFECT**  
Facile da pulire e sanificare

**ECO-FRIENDLY**  
Ama l'ambiente

**LONG LASTING**  
Dura a lungo

**RESISTANT**  
Resistente

**ZERO PVC**  
Zero PVC

DISCOVER  
MORE



INDEX



A COMPLETE  
PRODUCT  
SYSTEM >

PRODUCT  
FINDER >

SURFACE  
RANGE >

COMPANY >

COLLECTIONS >

LARGE SIZES >

SLABS FOR  
COUNTERTOPS  
& FURNITURE >

SINKS &  
BATHROOM  
FURNISHING >

FACADES >

TECHNICAL  
SPECIFICATIONS >



# Collections

## 3D Wall

- ↔ 3D WALL CARVE
- ↔ 3D WALL DESIGN

In collaboration with **Piero Lissoni**

- ↔ APLOMB
- ↔ ARTY

## Concrete & Resin look

- ↔ BOOST
- ↔ BOOST NATURAL
- ↔ BOOST PRO
- ↔ CANONE INVERSO
- ↔ DWELL
- ↔ PRISM
- ↔ VENTI BOOST

In collaboration with **Matteo Brioni**

In collaboration with **Piero Lissoni**

In collaboration with **Piero Lissoni**

## Metal Look

- ↔ BLAZE

## Marble Look

- ↔ MARVEL
- ↔ MARVEL DREAM
- ↔ MARVEL EDGE
- ↔ MARVEL GALA
- ↔ MARVEL GEMS
- ↔ MARVEL PRO
- ↔ MARVEL SHINE
- ↔ MARVEL STONE
- ↔ MARVEL TRAVERTINE
- ↔ MARVEL X

In collaboration with **HBA**

## Stone Look

- ↔ AIX
- ↔ BOOST MIX
- ↔ BOOST STONE
- ↔ BRAVE
- ↔ KLIF
- ↔ KONE
- ↔ LIMS
- ↔ MARVEL STONE
- ↔ MARVEL TRAVERTINE
- ↔ NORDE
- ↔ TRUST

In collaboration with **HBA**

## Wood Look

- ↔ AXI
- ↔ ENTICE
- ↔ ETIC
- ↔ ETIC PRO
- ↔ EXENCE
- ↔ HEARTWOOD
- ↔ NID

INDEX



A COMPLETE PRODUCT SYSTEM



PRODUCT FINDER



SURFACE RANGE



COMPANY



COLLECTIONS



3D WALL  
CONCRETE & RESIN LOOK  
METAL LOOK  
MARBLE LOOK  
STONE LOOK  
WOOD LOOK

LARGE SIZES



SLABS FOR COUNTERTOPS & FURNITURE



SINKS & BATHROOM FURNISHING



FACADES



TECHNICAL SPECIFICATIONS



# 3D Wall Carve

3D Sign + 3S Squares: Capsule Collection by **Piero Lissoni**

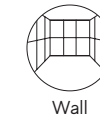

## Wall Tiles RECTIFIED MONOCALIBER

Sizes	Thickness	Surface finish
40x80 cm - 15 <sup>3</sup> / <sub>4</sub> "x31 <sup>1</sup> / <sub>2</sub> "	± 8,5 mm	Matte
<b>3D WALL TILES</b> 40x80 cm - 15 <sup>3</sup> / <sub>4</sub> "x31 <sup>1</sup> / <sub>2</sub> "	± 8,5 mm	Matte

## 3D SIGN + 3D SQUARES : DESIGN BY PIERO LISSONI



INDEX



A COMPLETE  
PRODUCT  
SYSTEM >

PRODUCT  
FINDER >

SURFACE  
RANGE >

COMPANY >

COLLECTIONS >

3D WALL  
CONCRETE & RESIN LOOK  
METAL LOOK  
MARBLE LOOK  
STONE LOOK  
WOOD LOOK

LARGE SIZES >

SLABS FOR  
COUNTERTOPS  
& FURNITURE >

SINKS &  
BATHROOM  
FURNISHING >

FACADES >

TECHNICAL  
SPECIFICATIONS >

# 3D Wall Carve

## MATTE SURFACE



± 8,5 mm

40x80 cm - 15<sup>3</sup>/<sub>4</sub>"x31<sup>1</sup>/<sub>2</sub>"

A57T 3D Wall Carve Field White

A57U 3D Wall Carve Field Pearl

A57V 3D Wall Carve Field Ivory



± 8,5 mm 3D WALL

40x80 cm - 15<sup>3</sup>/<sub>4</sub>"x31<sup>1</sup>/<sub>2</sub>"

A57W 3D Wall Carve Sign White

A57X 3D Wall Carve Sign Pearl

A57Y 3D Wall Carve Sign Ivory

A57Z 3D Wall Carve Squares White

A57Ø 3D Wall Carve Squares Pearl

A571 3D Wall Carve Squares Ivory

A572 3D Wall Carve Chisel White

A573 3D Wall Carve Chisel Pearl

A574 3D Wall Carve Chisel Ivory

A575 3D Wall Carve Whittle White

A576 3D Wall Carve Whittle Pearl

A577 3D Wall Carve Whittle Ivory

A578 3D Wall Carve Leaf White

A58A 3D Wall Carve Leaf Pearl

A579 3D Wall Carve Leaf Ivory

## TRIM TILES



1,4x40 cm - <sup>5</sup>/<sub>8</sub>"x15<sup>3</sup>/<sub>4</sub>"

A60A 3D Wall Carve Field White Corner 40 \*

A60B 3D Wall Carve Field Pearl Corner 40 \*

A60C 3D Wall Carve Field Ivory Corner 40 \*



1,4x1,4 cm - <sup>5</sup>/<sub>8</sub>"x<sup>5</sup>/<sub>8</sub>"

A60D 3D Wall Carve Field White Corner A.E. \*

A60E 3D Wall Carve Field Pearl Corner A.E. \*

A60F 3D Wall Carve Field Ivory Corner A.E. \*

V1 Uniform Appearance

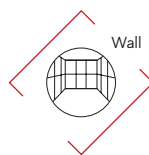

3D SIGN + 3D SQUARES : DESIGN BY PIERO LISSONI

\* These parts are supplied to order - I pezzi sono disponibili su ordinazione - Les pièces sont disponibles sur commande - Die Teile sind auf Bestellung lieferbar - Las piezas se hacen por encargo - Изготавливаются на заказ

INDEX



A COMPLETE PRODUCT SYSTEM



PRODUCT FINDER



SURFACE RANGE



COMPANY



COLLECTIONS



3D WALL  
CONCRETE & RESIN LOOK  
METAL LOOK  
MARBLE LOOK  
STONE LOOK  
WOOD LOOK

LARGE SIZES



SLABS FOR COUNTERTOPS & FURNITURE



SINKS & BATHROOM FURNISHING



FACADES



TECHNICAL SPECIFICATIONS



# 3D Wall Design

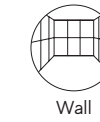

Wall

## Wall Tiles RECTIFIED MONOCALIBER

Sizes	Thickness	Surface finish
50x120 cm - 19 5/8"x47 1/4"	± 11 mm	Matte, Shiny
	± 8,5 mm	Matte Shiny
40x80 cm - 15 3/4"x31 1/2"	± 10 mm	Matte, Shiny
	± 8,5 mm	Matte, Shiny
30,5x56 cm - 12"x22"	± 9,5 mm	Matte
	± 8,5 mm	Matte

SOLID WHITE MATTE	SOLID WHITE GLOSSY	SOLID SAND MATTE
3D LINE WHITE MATTE	3D FLOWS WHITE MATTE	3D WAVE ARTY SUGAR MATTE
3D WIND WHITE MATTE	3D WAVE WHITE GLOSSY	3D WAVE ARTY MILK MATTE
3D RIBBON WHITE MATTE	3D DUNE WHITE MATTE	3D DUNE SAND MATTE
3D ULTRA BLADE WHITE MATTE	3D BLADE WHITE MATTE	3D BLADE ROSE MATTE
3D STARS WHITE MATTE	3D ANGLE WHITE MATTE	3D TWIST 80 SAGE MATTE
3D FLASH WHITE MATTE	3D DIAMOND WHITE MATTE	3D DIAMOND NIGHT MATTE

INDEX



A COMPLETE PRODUCT SYSTEM



PRODUCT FINDER



SURFACE RANGE



COMPANY



COLLECTIONS



- 3D WALL
- CONCRETE & RESIN LOOK
- METAL LOOK
- MARBLE LOOK
- STONE LOOK
- WOOD LOOK

LARGE SIZES



SLABS FOR COUNTERTOPS & FURNITURE



SINKS & BATHROOM FURNISHING



FACADES



TECHNICAL SPECIFICATIONS



# 3D Wall Design

## Wall Tiles

### MATTE SURFACE

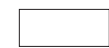

± 11 mm

50x120 cm - 19<sup>5</sup>/<sub>8</sub>"x47<sup>1</sup>/<sub>4</sub>"

A6BJ 3D Wall Design 3D Ultra Blade White <sup>(2)</sup>

A6BH 3D Wall Design 3D Line White <sup>(2)</sup>

A6BI 3D Wall Design 3D Flows White <sup>(2)</sup>



± 8,5 mm

50x120 cm - 19<sup>5</sup>/<sub>8</sub>"x47<sup>1</sup>/<sub>4</sub>"

A6BF 3D Wall Design Solid White



± 10 mm

40x80 cm - 15<sup>3</sup>/<sub>4</sub>"x31<sup>1</sup>/<sub>2</sub>"

8DMA 3D Wall Design 3D Angle White <sup>(2)</sup>

8DBW 3D Wall Design 3D Blade White <sup>(2)</sup>

8DAW 3D Wall Design 3D Stars White <sup>(2)</sup>

8DDI 3D Wall Design 3D Diamond White <sup>(2)</sup>

8DDN 3D Wall Design 3D Diamond Night <sup>(2)</sup>

8DFW 3D Wall Design 3D Flash White <sup>(2)</sup>

8DUW 3D Wall Design 3D Dune White <sup>(2)</sup>

8DUS 3D Wall Design 3D Dune Sand <sup>(2)</sup>

8DMW 3D Wall Design 3D Wind White <sup>(2)</sup>

8AWS 3D Wall Design 3D Wave Arty Sugar <sup>(2)</sup>

8AWM 3D Wall Design 3D Wave Arty Milk <sup>(2)</sup>

8SBW 3D Wall Design 3D Ribbon White <sup>(2)</sup>

8DSM 3D Wall Design 3D Twist Sage 80 <sup>(2)</sup>

A6PA 3D Wall Design 3D Blade Rose <sup>(2)</sup>



± 8,5 mm

40x80 cm - 15<sup>3</sup>/<sub>4</sub>"x31<sup>1</sup>/<sub>2</sub>"

8DSO 3D Wall Design Solid White

8DSA 3D Wall Design Solid Sand



± 9,5 mm

30,5x56 cm - 12"x22"

9D5B 3D Wall Design 3D Ultra Blade White <sup>(2)</sup>

9D5W 3D Wall Design 3D Wave White <sup>(2)</sup>



± 8,5 mm

30,5x56 cm - 12"x22"

9D5S 3D Wall Design Solid White

### SHINY SURFACE



± 8,5 mm

50x120 cm - 19<sup>5</sup>/<sub>8</sub>"x47<sup>1</sup>/<sub>4</sub>"

A6BG 3D Wall Design Solid White Glossy



± 10 mm

40x80 cm - 15<sup>3</sup>/<sub>4</sub>"x31<sup>1</sup>/<sub>2</sub>"

8DWG 3D Wall Design 3D Wave White Glossy <sup>(2)</sup>



± 8,5 mm

40x80 cm - 15<sup>3</sup>/<sub>4</sub>"x31<sup>1</sup>/<sub>2</sub>"

8DSL 3D Wall Design Solid White Glossy

### TRIM TILES

LD8W Spigolo 8,5mm White  
0,8x20 cm - <sup>3</sup>/<sub>8</sub>"x7<sup>7</sup>/<sub>8</sub>"

A8DW Spigolo 8,5mm White A.E.  
0,8x0,8 cm - <sup>3</sup>/<sub>8</sub>"x<sup>3</sup>/<sub>8</sub>"

LDWM Spigolo 10mm White \* <sup>(1)</sup>  
1x20 cm - <sup>3</sup>/<sub>8</sub>"x7<sup>7</sup>/<sub>8</sub>"

LDWG Spigolo 10mm White Glossy \* <sup>(1)</sup>  
1x20 cm - <sup>3</sup>/<sub>8</sub>"x7<sup>7</sup>/<sub>8</sub>"

LDAM Spigolo 10mm Sand \* <sup>(1)</sup>  
1x20 cm - <sup>3</sup>/<sub>8</sub>"x7<sup>7</sup>/<sub>8</sub>"

LDNM Spigolo 10mm Night \* <sup>(1)</sup>  
1x20 cm - <sup>3</sup>/<sub>8</sub>"x7<sup>7</sup>/<sub>8</sub>"

\* These parts are supplied to order - I pezzi sono disponibili su ordinazione - Les pièces sont disponibles sur commande - Die Teile sind auf Bestellung lieferbar - Las piezas se hacen por encargo - Изготавливаются на заказ

<sup>(1)</sup> The 10 mm edge matches three-dimensional wall tiles having a 10-11 mm thickness - Lo spigolo 10 mm si abbina a rivestimenti tridimensionali di spessore 10-11 mm - Le bord 10 mm s'adapte aux revêtements tridimensionnels épaisseur 10-11 mm - Die 10 mm Kante ist mit dreidimensionalen Wandfliesen mit einer Stärke von 10-11 mm kombinierbar - La arista de 10 mm se combina con revestimientos tridimensionales de 10-11 mm de grosor - Угловой элемент 10 мм сочетается с трехмерной настенной плиткой толщиной 10-11 мм

<sup>(2)</sup> Registered Community Design

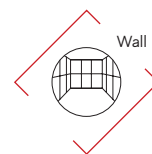

### DECOR RANGE

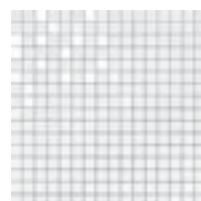

9DSM 3D Wall Design Solid White Mosaic  
30,5x30,5 cm - 12"x12"

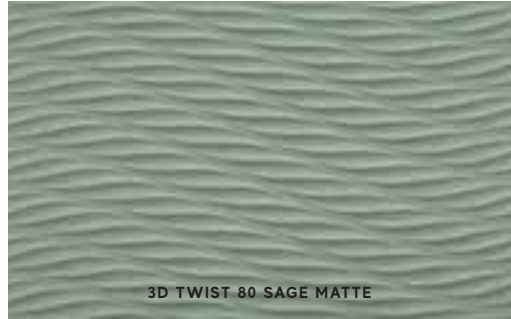
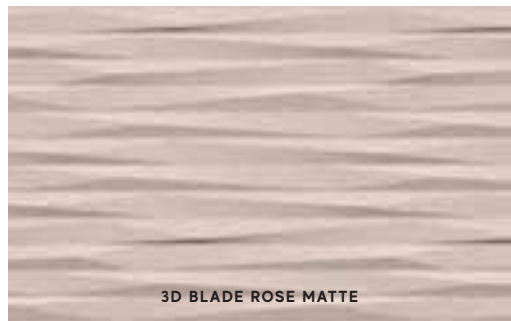

INDEX



A COMPLETE  
PRODUCT  
SYSTEM



PRODUCT  
FINDER



SURFACE  
RANGE



COMPANY



COLLECTIONS



3D WALL  
CONCRETE & RESIN LOOK  
METAL LOOK  
MARBLE LOOK  
STONE LOOK  
WOOD LOOK

LARGE SIZES



SLABS FOR  
COUNTERTOPS  
& FURNITURE



SINKS &  
BATHROOM  
FURNISHING



FACADES



TECHNICAL  
SPECIFICATIONS





# Aplomb

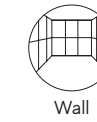



## Wall Tiles RECTIFIED MONOCALIBER

**Sizes** 50x120 cm - 19<sup>3</sup>/<sub>8</sub>"x47<sup>1</sup>/<sub>4</sub>"      **Thickness** ± 8,5 mm      **Surface finish** Matte



INDEX 

A COMPLETE PRODUCT SYSTEM 

PRODUCT FINDER 

SURFACE RANGE 

COMPANY 

COLLECTIONS 

3D WALL  
 CONCRETE & RESIN LOOK  
 METAL LOOK  
 MARBLE LOOK  
 STONE LOOK  
 WOOD LOOK

LARGE SIZES 

SLABS FOR COUNTERTOPS & FURNITURE 

SINKS & BATHROOM FURNISHING 

FACADES 

TECHNICAL SPECIFICATIONS 

# Aplomb

## Wall Tiles

### MATTE SURFACE



± 8,5 mm

50x120 cm - 19<sup>5</sup>/<sub>8</sub>"x47<sup>1</sup>/<sub>4</sub>"

- A6E5 Aplomb Canvas Minidots
- A6E4 Aplomb Cream Minidots
- A6E3 Aplomb White Minidots
- A6E6 Aplomb Denim Minidots
- A6IL Aplomb Lichen Minidots
- A6E9 Aplomb Canvas Stripes
- A6E8 Aplomb Cream Stripes
- A6E7 Aplomb White Stripes
- A6FA Aplomb Denim Stripes
- A6IM Aplomb Lichen Stripes

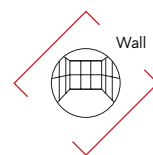

VI Uniform Appearance



### TRIM TILES



1,4x50 cm - <sup>5</sup>/<sub>8</sub>"x19<sup>5</sup>/<sub>8</sub>"

- A6NH Aplomb Canvas Minidots Corner 50 \*
- A6NG Aplomb Cream Minidots Corner 50 \*
- A6NF Aplomb White Minidots Corner 50 \*
- A6NJ Aplomb Denim Minidots Corner 50 \*
- A6NI Aplomb Lichen Minidots Corner 50 \*
- A6NM Aplomb Canvas Stripes Corner 50 \*
- A6NL Aplomb Cream Stripes Corner 50 \*
- A6NK Aplomb White Stripes Corner 50 \*
- A6NO Aplomb Denim Stripes Corner 50 \*
- A6NN Aplomb Lichen Stripes Corner 50 \*



1,4x1,4 cm - <sup>5</sup>/<sub>8</sub>"x<sup>5</sup>/<sub>8</sub>"

- A6NR Aplomb Canvas Minidots Corner A.E \*
- A6NQ Aplomb Cream Minidots Corner A.E \*
- A6NP Aplomb White Minidots Corner A.E \*
- A6NT Aplomb Denim Minidots Corner A.E \*
- A6NS Aplomb Lichen Minidots Corner A.E \*
- A6NW Aplomb Canvas Stripes Corner A.E \*
- A6NV Aplomb Cream Stripes Corner A.E \*
- A6NU Aplomb White Stripes Corner A.E \*
- A6NY Aplomb Denim Stripes Corner A.E \*
- A6NX Aplomb Lichen Stripes Corner A.E \*

\* These parts are supplied to order - I pezzi sono disponibili su ordinazione - Les pièces sont disponibles sur commande - Die Teile sind auf Bestellung lieferbar - Las piezas se hacen por encargo - Изготавливаются на заказ

### DECOR RANGE

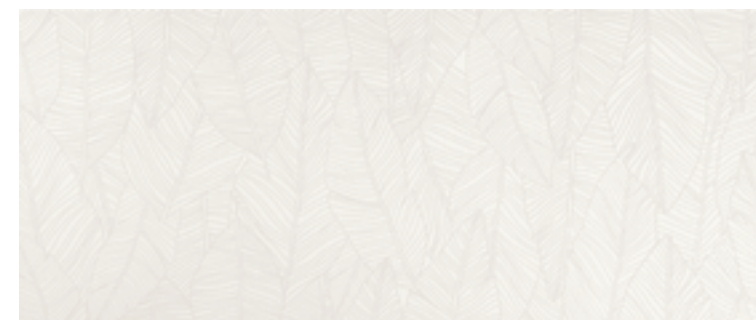

A6FC Aplomb White Leaf  
50x120 cm - 19<sup>5</sup>/<sub>8</sub>"x47<sup>1</sup>/<sub>4</sub>"

3 patterns with no graphic continuity / 3 pattern senza continuità grafica.

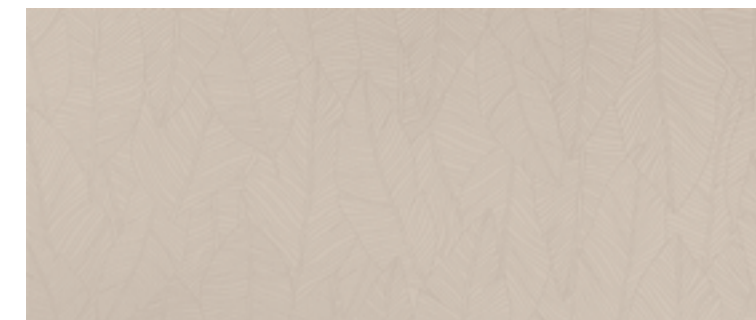

A6FD Aplomb Canvas Leaf  
50x120 cm - 19<sup>5</sup>/<sub>8</sub>"x47<sup>1</sup>/<sub>4</sub>"

3 patterns with no graphic continuity / 3 pattern senza continuità grafica.

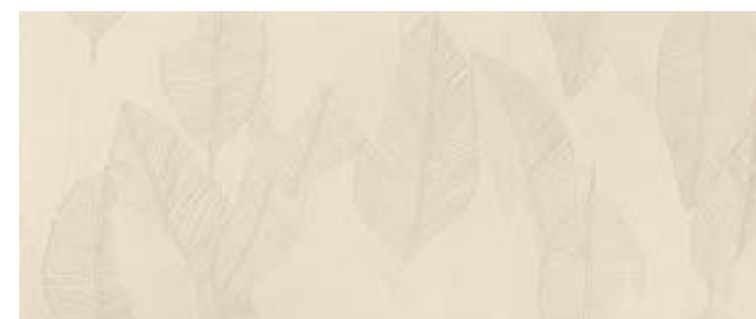

A6SH Aplomb Cream Leaf Lux <sup>(1)</sup>  
50x120 cm - 19<sup>5</sup>/<sub>8</sub>"x47<sup>1</sup>/<sub>4</sub>"

1 patterns with graphic continuity / 1 pattern con continuità grafica.



A6SI Aplomb Lichen Leaf Lux <sup>(1)</sup>  
50x120 cm - 19<sup>5</sup>/<sub>8</sub>"x47<sup>1</sup>/<sub>4</sub>"

1 patterns with graphic continuity / 1 pattern con continuità grafica.



A6SJ Aplomb Canvas Flora <sup>(1)</sup>  
50x120 cm - 19<sup>5</sup>/<sub>8</sub>"x47<sup>1</sup>/<sub>4</sub>"

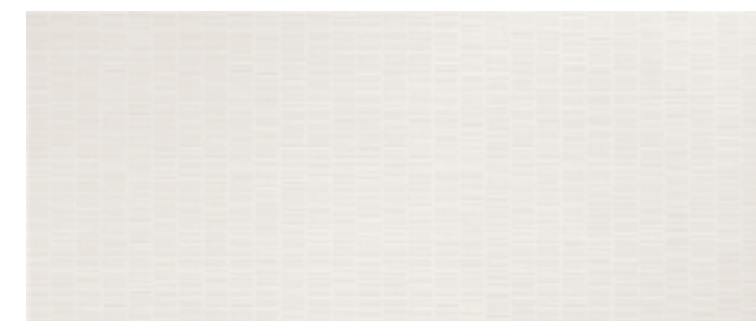

A6FB Aplomb White Mesh <sup>(2)</sup>  
50x120 cm - 19<sup>5</sup>/<sub>8</sub>"x47<sup>1</sup>/<sub>4</sub>"



A6VØ Aplomb Fabric Light <sup>(1)</sup>  
50x120 cm - 19<sup>5</sup>/<sub>8</sub>"x47<sup>1</sup>/<sub>4</sub>"

It can be combined with / Abbinabile con / Peut être combiné avec /  
Kombinierbar mit / Combinabile con / Совместимы с:  
**Minidots Cream**



A6V1 Aplomb Fabric Dark <sup>(1)</sup>  
50x120 cm - 19<sup>5</sup>/<sub>8</sub>"x47<sup>1</sup>/<sub>4</sub>"

It can be combined with / Abbinabile con / Peut être combiné avec /  
Kombinierbar mit / Combinabile con / Совместимы с:  
**Minidots Lichen - Minidots Cream**

<sup>(1)</sup> Application of decorative materials. The use of a common mild detergent is recommended. Avoid using acidic or alkaline products, waxes, steel wool, or abrasives. - Applicazione di materie decorative. Si consiglia l'utilizzo di un comune detergente neutro. Evitare l'utilizzo di prodotti acidi o alcalini, ceranti e pagliette di metallo o abrasive. - Application de matériaux décoratifs. Nous conseillons l'emploi de détergents neutres courants. Éviter l'utilisation de cires et de produits acides ou alcalins, ainsi que les pailles métalliques ou abrasives. - Dekorationsmaterial. Es empfiehlt sich, ein haushaltsübliches, neutrales Reinigungsmittel zu verwenden. Saure oder alkalische Produkte, Wachs sowie Stahlwolle- bzw. Scheuerschwämme sind zu vermeiden. Aplicación de materiales decorativos. Recomendamos utilizar un detergente neutro común. Hay que evitar el uso de productos ácidos o alcalinos, ceras y estropajos de metal o abrasivos. - Применение декоративных материалов. Рекомендуется чистить обычным нейтральным моющим средством. Не рекомендуется использовать кислотные, щелочные, восковые средства, а также металлические мочалки.

<sup>(2)</sup> Item sold by square meter. - Articolo venduto al mq. - Article vendu au mètre carré. - Artikel pro m<sup>2</sup> verkauft. - Artículo vendido por m<sup>2</sup>. - Артикул продается квадратными метрами.

INDEX



A COMPLETE  
PRODUCT  
SYSTEM



PRODUCT  
FINDER



SURFACE  
RANGE



COMPANY



COLLECTIONS



3D WALL  
CONCRETE & RESIN LOOK  
METAL LOOK  
MARBLE LOOK  
STONE LOOK  
WOOD LOOK

LARGE SIZES



SLABS FOR  
COUNTERTOPS  
& FURNITURE



SINKS &  
BATHROOM  
FURNISHING



FACADES



TECHNICAL  
SPECIFICATIONS



# Aplomb

## Wall Tiles

### DECOR RANGE



A6SP Aplomb White Mosaico Triangle ▲ 31,5x30,5 - 12<sup>7</sup>/<sub>8</sub>"x12"  
 A6SQ Aplomb Cream Mosaico Triangle ▲ 31,5x30,5 - 12<sup>7</sup>/<sub>8</sub>"x12"  
 A6SR Aplomb Canvas Mosaico Triangle ▲ 31,5x30,5 - 12<sup>7</sup>/<sub>8</sub>"x12"  
 A6SS Aplomb Lichen Mosaico Triangle ▲ 31,5x30,5 - 12<sup>7</sup>/<sub>8</sub>"x12"  
 A6ST Aplomb Denim Mosaico Triangle ▲ 31,5x30,5 - 12<sup>7</sup>/<sub>8</sub>"x12"



A6SK Aplomb White Mosaico Arch (1) 32x32 - 12<sup>5</sup>/<sub>8</sub>"x12<sup>5</sup>/<sub>8</sub>"  
 A6SL Aplomb Cream Mosaico Arch (1) 32x32 - 12<sup>5</sup>/<sub>8</sub>"x12<sup>5</sup>/<sub>8</sub>"  
 A6SM Aplomb Canvas Mosaico Arch (1) 32x32 - 12<sup>5</sup>/<sub>8</sub>"x12<sup>5</sup>/<sub>8</sub>"  
 A6SN Aplomb Lichen Mosaico Arch (1) 32x32 - 12<sup>5</sup>/<sub>8</sub>"x12<sup>5</sup>/<sub>8</sub>"  
 A6SO Aplomb Denim Mosaico Arch (1) 32x32 - 12<sup>5</sup>/<sub>8</sub>"x12<sup>5</sup>/<sub>8</sub>"



A6SU Aplomb White Mosaico Net (2) 30x30 - 11<sup>1</sup>/<sub>4</sub>"x11<sup>1</sup>/<sub>4</sub>"  
 A6SV Aplomb Cream Mosaico Net (2) 30x30 - 11<sup>1</sup>/<sub>4</sub>"x11<sup>1</sup>/<sub>4</sub>"  
 A6SW Aplomb Canvas Mosaico Net (2) 30x30 - 11<sup>1</sup>/<sub>4</sub>"x11<sup>1</sup>/<sub>4</sub>"  
 A6SX Aplomb Lichen Mosaico Net (2) 30x30 - 11<sup>1</sup>/<sub>4</sub>"x11<sup>1</sup>/<sub>4</sub>"  
 A6SY Aplomb Denim Mosaico Net (2) 30x30 - 11<sup>1</sup>/<sub>4</sub>"x11<sup>1</sup>/<sub>4</sub>"

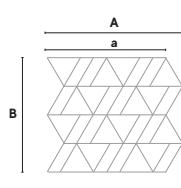

A 35,9 cm - 15<sup>1</sup>/<sub>8</sub>"  
 a 30,5 cm - 12"

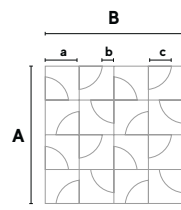

A 32 cm - 12<sup>5</sup>/<sub>8</sub>"  
 B 32 cm - 12<sup>5</sup>/<sub>8</sub>"  
 a 7,8 cm - 3<sup>1</sup>/<sub>8</sub>"  
 b 2,533 cm - 1"  
 c 5,167 cm - 2"

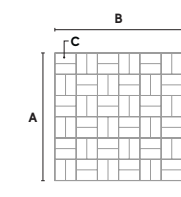

A 30 cm - 11<sup>1</sup>/<sub>4</sub>"  
 B 30 cm - 11<sup>1</sup>/<sub>4</sub>"  
 C 4,88x2,36 cm - 1<sup>7</sup>/<sub>8</sub>"x1<sup>3</sup>/<sub>8</sub>"



© Ceramiche Atlas Concorde



© Ceramiche Atlas Concorde



© Ceramiche Atlas Concorde

INDEX



A COMPLETE PRODUCT SYSTEM



PRODUCT FINDER



SURFACE RANGE



COMPANY



COLLECTIONS



- 3D WALL
- CONCRETE & RESIN LOOK
- METAL LOOK
- MARBLE LOOK
- STONE LOOK
- WOOD LOOK

LARGE SIZES



SLABS FOR COUNTERTOPS & FURNITURE



SINKS & BATHROOM FURNISHING



FACADES



TECHNICAL SPECIFICATIONS



<sup>(1)</sup> The tesserae come from Minidots and Stripes Textures - Le tessere sono ricavate dalle texture minidots e stripes - Les tesselles proviennent des textures minidots et stripes - Die Mosaiksteinchen stammen aus den Textures Minidots und Stripes - Los mosaicos se obtienen de las texturas minidots y stripes - Тессеры вырезаны из структур minidots и stripes

<sup>(2)</sup> The tesserae come from Minidots Textures - Le tessere sono ricavate dalle texture minidots - Les tesselles proviennent des Textures Minidots - Die Mosaiksteinchen stammen aus den Textures Minidots - Los mosaicos se obtienen de las texturas minidots - Тессеры вырезаны из структур Minidots

# Arty



© Ceramiche Atlas Concorde



© Ceramiche Atlas Concorde



© Ceramiche Atlas Concorde

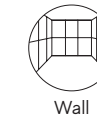

Wall



## Wall Tiles RECTIFIED MONOCALIBER

Sizes	Thickness	Surface finish
40x80 cm - 15 <sup>3</sup> / <sub>4</sub> "x31 <sup>1</sup> / <sub>2</sub> "	± 8,5 mm	Matte
<b>3D WALL TILES</b> 40x80 cm - 15 <sup>3</sup> / <sub>4</sub> "x31 <sup>1</sup> / <sub>2</sub> "	± 10 mm	Matte

INDEX

A COMPLETE PRODUCT SYSTEM

PRODUCT FINDER

SURFACE RANGE

COMPANY

COLLECTIONS

- 3D WALL
- CONCRETE & RESIN LOOK
- METAL LOOK
- MARBLE LOOK
- STONE LOOK
- WOOD LOOK

LARGE SIZES

SLABS FOR COUNTERTOPS & FURNITURE

SINKS & BATHROOM FURNISHING

FACADES

TECHNICAL SPECIFICATIONS

# Arty Wall Tiles

## MATTE SURFACE

± 8.5 mm  
40x80 cm - 15<sup>7</sup>/<sub>8</sub>"x31<sup>1</sup>/<sub>2</sub>"  
8ARU Arty Sugar  
8ARL Arty Milk  
8ARA Arty Charcoal  
8ARN Arty Malt  
8ARD Arty Curry  
8ARB Arty Tabasco

± 10 mm 3D WALL  
40x80 cm - 15<sup>7</sup>/<sub>8</sub>"x31<sup>1</sup>/<sub>2</sub>"  
8AWS Arty Sugar Wave  
8AWM Arty Milk Wave

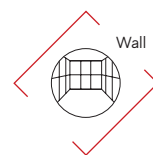

V1 Uniform Appearance



## TRIM TILES

LASS Arty Sugar Spigolo  
0,8x20 - 3<sup>1</sup>/<sub>8</sub>"x7<sup>7</sup>/<sub>8</sub>"

AASS Spigolo A.E.  
0,8x0,8 - 3<sup>1</sup>/<sub>8</sub>"x3<sup>1</sup>/<sub>8</sub>"

LASH Arty Charcoal Spigolo  
0,8x20 - 3<sup>1</sup>/<sub>8</sub>"x7<sup>7</sup>/<sub>8</sub>"

AASH Spigolo A.E.  
0,8x0,8 - 3<sup>1</sup>/<sub>8</sub>"x3<sup>1</sup>/<sub>8</sub>"

LASC Arty Curry Spigolo  
0,8x20 - 3<sup>1</sup>/<sub>8</sub>"x7<sup>7</sup>/<sub>8</sub>"

AASU Spigolo A.E.  
0,8x0,8 - 3<sup>1</sup>/<sub>8</sub>"x3<sup>1</sup>/<sub>8</sub>"

LASK Arty Milk Spigolo  
0,8x20 - 3<sup>1</sup>/<sub>8</sub>"x7<sup>7</sup>/<sub>8</sub>"

AASI Spigolo A.E.  
0,8x0,8 - 3<sup>1</sup>/<sub>8</sub>"x3<sup>1</sup>/<sub>8</sub>"

LASD Arty Malt Spigolo  
0,8x20 - 3<sup>1</sup>/<sub>8</sub>"x7<sup>7</sup>/<sub>8</sub>"

AASM Spigolo A.E.  
0,8x0,8 - 3<sup>1</sup>/<sub>8</sub>"x3<sup>1</sup>/<sub>8</sub>"

LASO Arty Tabasco Spigolo  
0,8x20 - 3<sup>1</sup>/<sub>8</sub>"x7<sup>7</sup>/<sub>8</sub>"

AASO Spigolo A.E.  
0,8x0,8 - 3<sup>1</sup>/<sub>8</sub>"x3<sup>1</sup>/<sub>8</sub>"

## DECOR RANGE



8ATM Arty Milk Textile  
40x80 - 15<sup>7</sup>/<sub>8</sub>"x31<sup>1</sup>/<sub>2</sub>"



8ATT Arty Tabasco Textile  
40x80 - 15<sup>7</sup>/<sub>8</sub>"x31<sup>1</sup>/<sub>2</sub>"



8A2S Arty Sugar Urban C2  
80x80 - 31<sup>1</sup>/<sub>2</sub>"x31<sup>1</sup>/<sub>2</sub>"



8A2C Arty Curry Urban C2  
80x80 - 31<sup>1</sup>/<sub>2</sub>"x31<sup>1</sup>/<sub>2</sub>"



8A2T Arty Tabasco Urban C2  
80x80 - 31<sup>1</sup>/<sub>2</sub>"x31<sup>1</sup>/<sub>2</sub>"



9ASS Arty Sugar  
Mosaico Minibrick  
30,5x30,5 - 12"x12"



9ASH Arty Charcoal  
Mosaico Minibrick  
30,5x30,5 - 12"x12"



9ASC Arty Curry  
Mosaico Minibrick  
30,5x30,5 - 12"x12"



9ASI Arty Milk  
Mosaico Minibrick  
30,5x30,5 - 12"x12"



9ASM Arty Malt  
Mosaico Minibrick  
30,5x30,5 - 12"x12"



9AST Arty Tabasco  
Mosaico Minibrick  
30,5x30,5 - 12"x12"

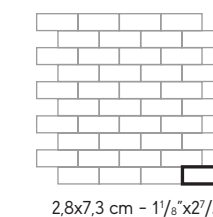

INDEX



A COMPLETE  
PRODUCT  
SYSTEM



PRODUCT  
FINDER



SURFACE  
RANGE



COMPANY



COLLECTIONS



3D WALL  
CONCRETE & RESIN LOOK  
METAL LOOK  
MARBLE LOOK  
STONE LOOK  
WOOD LOOK

LARGE SIZES



SLABS FOR  
COUNTERTOPS  
& FURNITURE



SINKS &  
BATHROOM  
FURNISHING



FACADES



TECHNICAL  
SPECIFICATIONS



# Canone Inverso

Decor collection by **Piero Lissoni**

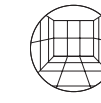

Floor & Wall

INDEX



A COMPLETE PRODUCT SYSTEM >

PRODUCT FINDER >

SURFACE RANGE >

COMPANY >

COLLECTIONS >

- 3D WALL
- CONCRETE & RESIN LOOK
- METAL LOOK
- MARBLE LOOK
- STONE LOOK
- WOOD LOOK

LARGE SIZES >

SLABS FOR COUNTERTOPS & FURNITURE >

SINKS & BATHROOM FURNISHING >

FACADES >

TECHNICAL SPECIFICATIONS >

## Porcelain Tiles



© Ceramiche Atlas Concorde



© Ceramiche Atlas Concorde



© Ceramiche Atlas Concorde



© Ceramiche Atlas Concorde

### CANONE INVERSO 1

81x32 cm 31<sup>1</sup>/<sub>8</sub>"x12<sup>5</sup>/<sub>8</sub>"  
A19U Canone Inverso 1



### CANONE INVERSO 2

59x59 cm 23"x23"  
A19V Canone Inverso 2



### CANONE INVERSO 3

47x147 cm 18<sup>1</sup>/<sub>2</sub>"x57<sup>7</sup>/<sub>8</sub>"  
A2US Canone Inverso 3



### CANONE INVERSO 4

59x78 cm 23<sup>1</sup>/<sub>4</sub>"x30<sup>3</sup>/<sub>4</sub>"  
A19X Canone Inverso 4



# Boost

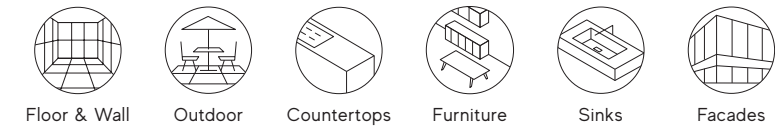

© Ceramiche Atlas Concorde



© Ceramiche Atlas Concorde



© Ceramiche Atlas Concorde

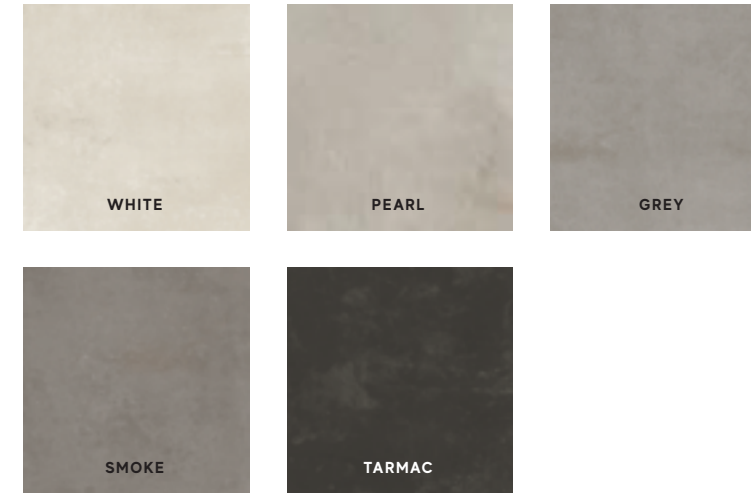

## Porcelain Tiles RECTIFIED MONOCALIBER

Sizes	Thickness	Surface finish
160x160 cm - 63"x63"	± 6 mm	Matte R9 A
120x278 cm - 47 1/4"x109 1/2"	± 6 mm	Matte R9 A
120x240 cm - 47 1/4"x94 1/2"	± 9 mm	Matte R10 B
120x120 cm - 47 1/4"x47 1/4"	± 6 mm	Matte R9 A
	± 9 mm	Matte Sensitech R10 B
60x120 cm - 23 5/8"x47 1/4"	± 9 mm	Matte Sensitech R10 B
75x150 cm - 29 1/2"x59"	± 9 mm	Matte Sensitech R10 B
75x75 cm - 29 1/2"x29 1/2"	± 9 mm	Matte Sensitech R10 B
60x60 cm - 23 5/8"x23 5/8"	± 9 mm	Matte Sensitech R10 B
30x60 cm - 11 3/4"x23 5/8"	± 9 mm	Matte Sensitech R10 B

LARGE SIZES P. 356

### OUTDOOR AND WET AREAS

120x120 cm - 47 1/4"x47 1/4"	± 9 mm	Grip R11 C
120x120 cm - 47 1/4"x47 1/4"	± 20 mm	Outdoor R11 C
120x120 cm - 47 1/4"x47 1/4"	± 20 mm	Outdoor R11 C
60x120 cm - 23 5/8"x47 1/4"	± 20 mm	Outdoor R11 C
90x90 cm - 35 3/8"x35 3/8"	± 20 mm	Outdoor R11 C
60x60 cm - 23 5/8"x23 5/8"	± 20 mm	Outdoor R11 C

### atlasPLAN

160x320 cm - 63"x126"	± 6 mm	Hammered R9 A
-----------------------	--------	---------------

### SLABS FOR COUNTERTOPS & FURNITURE

162x324 cm - 63 3/4"x127 1/2" NON-RECTIFIED	± 12-20 mm	Hammered
--	------------	----------



## Wall Tiles RECTIFIED MONOCALIBER

Sizes	Thickness	Surface finish
40x80 cm - 15 3/4"x31 1/2"	± 8,5 mm	Matte
3D WALL TILES		
40x80 cm - 15 3/4"x31 1/2"	± 10 mm	Matte

INDEX



A COMPLETE PRODUCT SYSTEM



PRODUCT FINDER



SURFACE RANGE



COMPANY



COLLECTIONS



3D WALL  
CONCRETE & RESIN LOOK  
METAL LOOK  
MARBLE LOOK  
STONE LOOK  
WOOD LOOK

LARGE SIZES



SLABS FOR COUNTERTOPS & FURNITURE



SINKS & BATHROOM FURNISHING



FACADES



TECHNICAL SPECIFICATIONS



# Boost

## Porcelain Tiles

### MATTE SURFACE



**± 6 mm**  
**160x320 cm** - 63"x126"  
 A05Z Boost White Hammered  
 A05Ø Boost Smoke Hammered  
 A68I Boost Grey Hammered  
 A68J Boost Tarmac Hammered

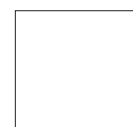

**± 6 mm**  
**160x160 cm** - 63"x63"  
 AØDE Boost White  
 AØDF Boost Smoke  
 A68K Boost Grey  
 A68L Boost Tarmac



**± 6 mm**  
**120x278 cm** - 47<sup>1</sup>/<sub>4</sub>"x109<sup>1</sup>/<sub>2</sub>"  
 AØBD Boost White  
 AØBE Boost Pearl  
 AØBF Boost Grey  
 AØBG Boost Smoke  
 AOQB Boost Tarmac



**± 6 mm**  
**120x120 cm** - 47<sup>1</sup>/<sub>4</sub>"x47<sup>1</sup>/<sub>4</sub>"  
 A2TK Boost White  
 A2TM Boost Pearl  
 A2TN Boost Grey  
 A2TO Boost Smoke  
 A2TP Boost Tarmac



**± 9 mm**  
**120x240 cm** - 47<sup>1</sup>/<sub>4</sub>"x94<sup>1</sup>/<sub>2</sub>"  
 AMGD Boost White  
 AMGE Boost Pearl  
 AMGF Boost Grey  
 AMGG Boost Smoke  
 AMGH Boost Tarmac



**± 9 mm**  
**120x120 cm** - 47<sup>1</sup>/<sub>4</sub>"x47<sup>1</sup>/<sub>4</sub>"  
 AMGI Boost White  
 AMGJ Boost Pearl  
 AMGK Boost Grey  
 AMGL Boost Smoke  
 AMGM Boost Tarmac



**± 9 mm**  
**60x120 cm** - 23<sup>3</sup>/<sub>8</sub>"x47<sup>1</sup>/<sub>4</sub>"  
 AØMO Boost White  
 AØMP Boost Pearl  
 AØMQ Boost Grey  
 AØMR Boost Smoke  
 AØMS Boost Tarmac



**± 9 mm**  
**60x60 cm** - 23<sup>3</sup>/<sub>8</sub>"x23<sup>3</sup>/<sub>8</sub>"  
 AMH3 Boost White  
 AMH4 Boost Pearl  
 AMH5 Boost Grey  
 AMH6 Boost Smoke  
 AMH7 Boost Tarmac



**± 9 mm**  
**30x60 cm** - 11<sup>3</sup>/<sub>4</sub>"x23<sup>3</sup>/<sub>8</sub>"  
 AMH8 Boost White  
 AMH9 Boost Pearl  
 AMIA Boost Grey  
 AMIC Boost Smoke  
 AMID Boost Tarmac



**± 9 mm**  
**75x150 cm** - 29<sup>1</sup>/<sub>2</sub>"x59"  
 A7GV Boost White  
 A7GW Boost Pearl  
 A7GX Boost Grey  
 A7GY Boost Smoke  
 A7GZ Boost Tarmac



**± 9 mm**  
**75x75 cm** - 29<sup>1</sup>/<sub>2</sub>"x29<sup>1</sup>/<sub>2</sub>"  
 AME6 Boost White  
 AME7 Boost Pearl  
 AMGV Boost Grey  
 AMGW Boost Smoke  
 AMGX Boost Tarmac

### GRIP SURFACE



**± 9 mm**  
**120x120 cm** - 47<sup>1</sup>/<sub>4</sub>"x47<sup>1</sup>/<sub>4</sub>"  
 AMGN Boost White Grip  
 AMGO Boost Pearl Grip  
 AMGP Boost Grey Grip  
 AMGQ Boost Smoke Grip  
 AMGR Boost Tarmac Grip

### OUTDOOR ± 20 mm



**± 20 mm**  
**120x240 cm** - 47<sup>1</sup>/<sub>4</sub>"x94<sup>1</sup>/<sub>2</sub>"  
 A2RØ Boost White 20 mm  
 A2R9 Boost Grey 20 mm



**± 20 mm**  
**120x120 cm** - 47<sup>1</sup>/<sub>4</sub>"x47<sup>1</sup>/<sub>4</sub>"  
 AMG3 Boost White 20 mm  
 AMG5 Boost Grey 20 mm  
 AMG6 Boost Smoke 20 mm  
 AMG7 Boost Tarmac 20 mm



**± 20 mm**  
**60x120 cm** - 23<sup>3</sup>/<sub>8</sub>"x47<sup>1</sup>/<sub>4</sub>"  
 AL8Ø Boost White 20 mm  
 AL81 Boost Grey 20 mm  
 AL82 Boost Smoke 20 mm  
 AL83 Boost Tarmac 20 mm



**± 20 mm**  
**60x60 cm** - 23<sup>3</sup>/<sub>8</sub>"x23<sup>3</sup>/<sub>8</sub>"  
 A3TJ Boost White 20 mm  
 A3TK Boost Grey 20 mm  
 A3TL Boost Smoke 20 mm  
 A3TM Boost Tarmac 20 mm



**± 20 mm**  
**90x90 cm** - 35<sup>3</sup>/<sub>8</sub>"x35<sup>3</sup>/<sub>8</sub>"  
 AMBØ Boost White 20 mm  
 AMB1 Boost Grey 20 mm  
 AMB2 Boost Smoke 20 mm  
 AMCK Boost Tarmac 20 mm

### COMPLETE YOUR PROJECT

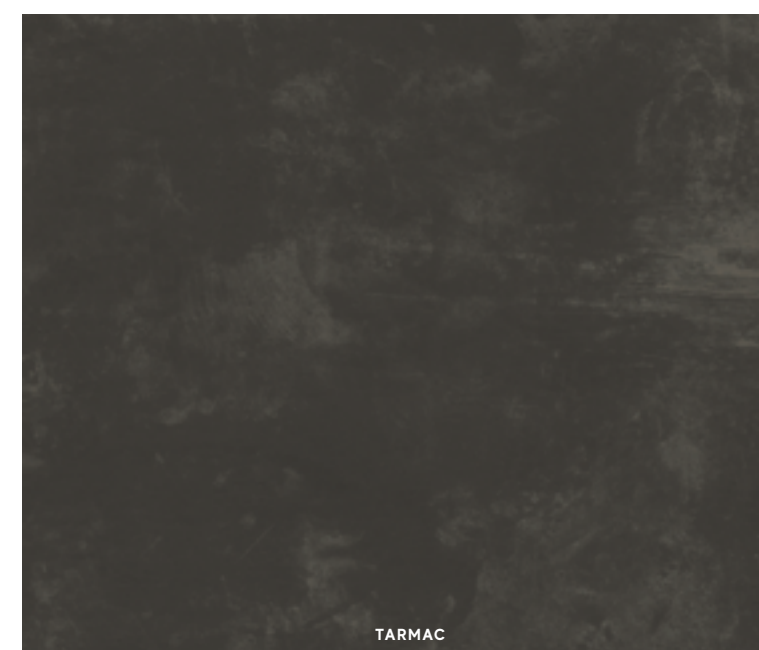
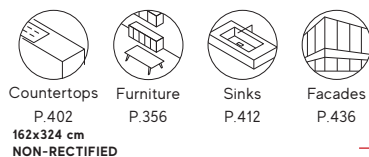

INDEX



A COMPLETE PRODUCT SYSTEM



PRODUCT FINDER



SURFACE RANGE



COMPANY



COLLECTIONS



3D WALL  
 CONCRETE & RESIN LOOK  
 METAL LOOK  
 MARBLE LOOK  
 STONE LOOK  
 WOOD LOOK

LARGE SIZES



SLABS FOR COUNTERTOPS & FURNITURE



SINKS & BATHROOM FURNISHING



FACADES



TECHNICAL SPECIFICATIONS







# Boost

## Wall Tiles



### MATTE SURFACE

- $\pm 8,5 \text{ mm}$
- 40x80 cm - 15<sup>5</sup>/<sub>8</sub>"x31<sup>1</sup>/<sub>2</sub>"
- 8B8W Boost White
- 8B8P Boost Pearl
- 8B8G Boost Grey
- 8B8K Boost Smoke
- 8B8S Boost Sage
- 8B8R Boost Red

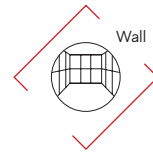

- $\pm 10 \text{ mm 3D WALL}$
- 40x80 cm - 15<sup>5</sup>/<sub>8</sub>"x31<sup>1</sup>/<sub>2</sub>"
- 8BUW Boost 3D Urban White
- 8BUP Boost 3D Urban Pearl
- 8BUG Boost 3D Urban Grey



### TRIM TILES

- 1,4x40 cm - 5<sup>5</sup>/<sub>8</sub>"x15<sup>5</sup>/<sub>8</sub>"
- LBBW Boost White Corner 40 \*
- LBBP Boost Pearl Corner 40 \*
- LBBY Boost Grey Corner 40 \*
- LBBH Boost Smoke Corner 40 \*
- LBBT Boost Sage Corner 40 \*
- LBBQ Boost Red Corner 40 \*

- 1,4x1,4 cm - 5<sup>5</sup>/<sub>8</sub>"x5<sup>5</sup>/<sub>8</sub>"
- AØAW Boost White Corner A.E. \*
- AØAP Boost Pearl Corner A.E. \*
- AØAG Boost Grey Corner A.E. \*
- AØAK Boost Smoke Corner A.E. \*
- AØAS Boost Sage Corner A.E. \*
- AØAR Boost Red Corner A.E. \*

### 3D TRIM TILES

- 1,4x40 cm - 5<sup>5</sup>/<sub>8</sub>"x15<sup>5</sup>/<sub>8</sub>"
- LB3W Boost White 3D Corner 40 \*
- LB3P Boost Pearl 3D Corner 40 \*
- LB3G Boost Grey 3D Corner 40 \*

\* These parts are supplied to order - I pezzi sono disponibili su ordinazione - Les pièces sont disponibles sur commande - Die Teile sind auf Bestellung lieferbar - Las piezas se hacen por encargo - Изготавливаются на заказ

### DECOR RANGE

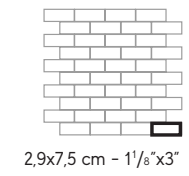

© Ceramiche Atlas Concorde

INDEX



A COMPLETE PRODUCT SYSTEM



PRODUCT FINDER



SURFACE RANGE



COMPANY



COLLECTIONS



- 3D WALL
- CONCRETE & RESIN LOOK
- METAL LOOK
- MARBLE LOOK
- STONE LOOK
- WOOD LOOK

LARGE SIZES



SLABS FOR COUNTERTOPS & FURNITURE



SINKS & BATHROOM FURNISHING



FACADES



TECHNICAL SPECIFICATIONS



# Boost Natural

In collaboration with **Matteo Brioni**

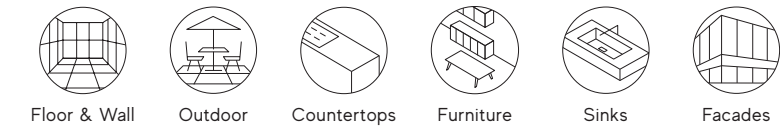

## Porcelain Tiles RECTIFIED MONOCALIBER

Sizes	Thickness	Surface finish
120x278 cm - 47 <sup>1</sup> / <sub>4</sub> "x109 <sup>1</sup> / <sub>2</sub> "	± 6 mm	Matte <b>R9 A</b>
120x120 cm - 47 <sup>1</sup> / <sub>4</sub> "x47 <sup>1</sup> / <sub>4</sub> "	± 9 mm	Matte <b>Sensitech R10 B</b>
60x120 cm - 23 <sup>5</sup> / <sub>8</sub> "x47 <sup>1</sup> / <sub>4</sub> "	± 9 mm	Matte <b>Sensitech R10 B</b>
60x60 cm - 23 <sup>5</sup> / <sub>8</sub> "x23 <sup>5</sup> / <sub>8</sub> "	± 9 mm	Matte <b>Sensitech R10 B</b>
30x60 cm - 11 <sup>3</sup> / <sub>4</sub> "x23 <sup>5</sup> / <sub>8</sub> "	± 9 mm	Matte <b>Sensitech R10 B</b>

LARGE SIZES P. 356

### OUTDOOR AND WET AREAS

Sizes	Thickness	Surface finish
120x120 cm - 47 <sup>1</sup> / <sub>4</sub> "x47 <sup>1</sup> / <sub>4</sub> "	± 9 mm	Grip <b>R11 C</b>
60x120 cm - 23 <sup>5</sup> / <sub>8</sub> "x47 <sup>1</sup> / <sub>4</sub> "	± 9 mm	Grip <b>R11 C</b>
120x120 cm - 47 <sup>1</sup> / <sub>4</sub> "x47 <sup>1</sup> / <sub>4</sub> "	± 20 mm	Outdoor <b>R11 C</b>
60x60 cm - 23 <sup>5</sup> / <sub>8</sub> "x23 <sup>5</sup> / <sub>8</sub> "	± 20 mm	Outdoor <b>R11 C</b>

### atlasPLAN

#### SLABS FOR COUNTERTOPS & FURNITURE

Sizes	Thickness	Surface finish
162x324 cm - 63 <sup>3</sup> / <sub>4</sub> "x127 <sup>1</sup> / <sub>2</sub> "	± 12 mm	Hammered





## Wall Tiles RECTIFIED MONOCALIBER

Sizes	Thickness	Surface finish
50x120 cm - 19 <sup>5</sup> / <sub>8</sub> "x47 <sup>1</sup> / <sub>4</sub> "	± 8,5 mm	Matte

**3D WALL TILES**

Sizes	Thickness	Surface finish
50x120 cm - 19 <sup>5</sup> / <sub>8</sub> "x47 <sup>1</sup> / <sub>4</sub> "	± 8,5 mm	Matte

INDEX 

A COMPLETE PRODUCT SYSTEM 

PRODUCT FINDER 

SURFACE RANGE 

COMPANY 

COLLECTIONS 

3D WALL  
 CONCRETE & RESIN LOOK  
 METAL LOOK  
 MARBLE LOOK  
 STONE LOOK  
 WOOD LOOK

LARGE SIZES 

SLABS FOR COUNTERTOPS & FURNITURE 

SINKS & BATHROOM FURNISHING 

FACADES 

TECHNICAL SPECIFICATIONS 

# Boost Natural

## Porcelain Tiles

### MATTE SURFACE



**± 6 mm**  
**120x278 cm** - 47<sup>1</sup>/<sub>4</sub>"x109<sup>1</sup>/<sub>2</sub>"  
 A67D Boost Natural Ecru  
 A67E Boost Natural Umber  
 A67F Boost Natural Coal  
 A67G Boost Natural Cobalt <sup>(1)</sup>  
 A67H Boost Natural Coral  
 A67B Boost Natural Kaolin  
 A67C Boost Natural Ash

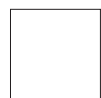

**± 9 mm** (S)  
**120x120 cm** - 47<sup>1</sup>/<sub>4</sub>"x47<sup>1</sup>/<sub>4</sub>"  
 A6WU Boost Natural Ecru  
 A65O Boost Natural Umber  
 A65P Boost Natural Coal  
 A65Q Boost Natural Cobalt <sup>(1)</sup>  
 A65R Boost Natural Coral  
 A65N Boost Natural Kaolin  
 A6WT Boost Natural Ash



**± 9 mm** (S)  
**60x120 cm** - 23<sup>5</sup>/<sub>8</sub>"x47<sup>1</sup>/<sub>4</sub>"  
 A6WW Boost Natural Ecru  
 A65T Boost Natural Umber  
 A65U Boost Natural Coal  
 A65V Boost Natural Cobalt <sup>(1)</sup>  
 A65W Boost Natural Coral  
 A65S Boost Natural Kaolin  
 A6VW Boost Natural Ash



**± 9 mm** (S)  
**60x60 cm** - 23<sup>5</sup>/<sub>8</sub>"x23<sup>5</sup>/<sub>8</sub>"  
 A66E Boost Natural Ecru  
 A66F Boost Natural Umber  
 A66G Boost Natural Coal  
 A658 Boost Natural Kaolin  
 A659 Boost Natural Ash



**± 9 mm** (S)  
**30x60 cm** - 11<sup>3</sup>/<sub>4</sub>"x23<sup>5</sup>/<sub>8</sub>"  
 A66J Boost Natural Ecru  
 A66K Boost Natural Umber  
 A66L Boost Natural Coal  
 A66H Boost Natural Kaolin  
 A66I Boost Natural Ash

### GRIP SURFACE

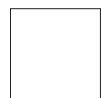

**± 9 mm**  
**120x120 cm** - 47<sup>1</sup>/<sub>4</sub>"x47<sup>1</sup>/<sub>4</sub>"  
 A655 Boost Natural Ecru Grip  
 A656 Boost Natural Umber Grip  
 A657 Boost Natural Coal Grip  
 A653 Boost Natural Kaolin Grip  
 A654 Boost Natural Ash Grip



**± 9 mm**  
**60x120 cm** - 23<sup>5</sup>/<sub>8</sub>"x47<sup>1</sup>/<sub>4</sub>"  
 A65Ø Boost Natural Ecru Grip  
 A651 Boost Natural Umber Grip  
 A652 Boost Natural Coal Grip  
 A65Y Boost Natural Kaolin Grip  
 A65Z Boost Natural Ash Grip

### OUTDOOR ± 20 mm

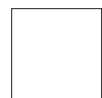

**± 20 mm**  
**120x120 cm** - 47<sup>1</sup>/<sub>4</sub>"x47<sup>1</sup>/<sub>4</sub>"  
 A7Q9 Boost Natural Ecru 20 mm  
 A7Q7 Boost Natural Kaolin 20 mm  
 A7Q8 Boost Natural Ash 20 mm



**± 20 mm**  
**60x60 cm** - 23<sup>5</sup>/<sub>8</sub>"x23<sup>5</sup>/<sub>8</sub>"  
 A7RC Boost Natural Ecru 20 mm  
 A7RA Boost Natural Kaolin 20 mm  
 A7RB Boost Natural Ash 20 mm

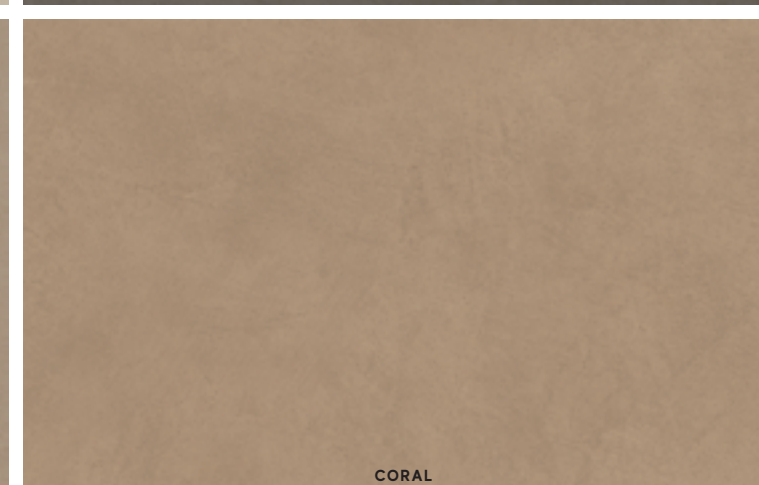
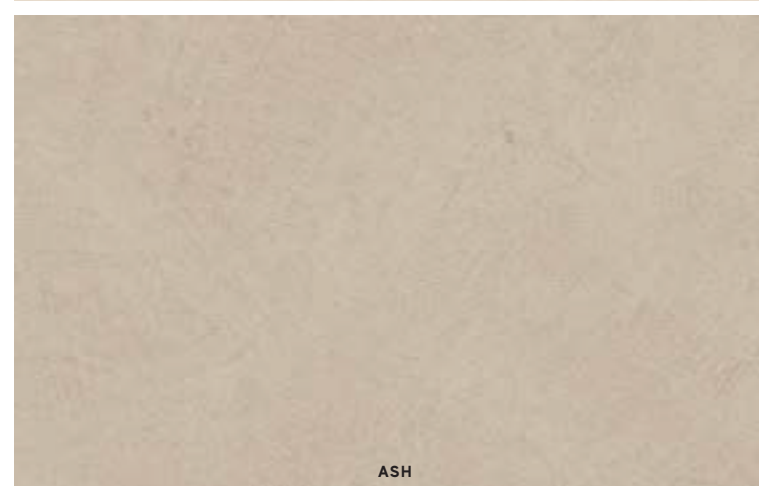
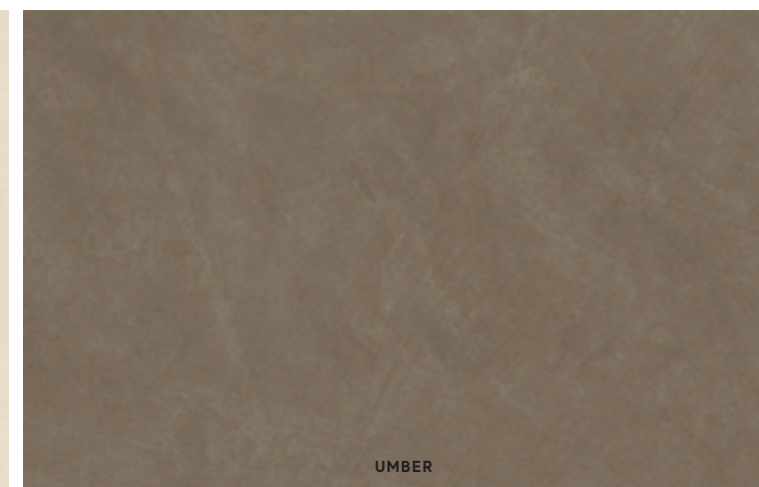
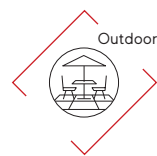

### COMPLETE YOUR PROJECT

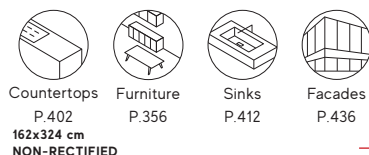

Countertops P.402  
 Furniture P.356  
 Sinks P.412  
 Facades P.436  
**162x324 cm NON-RECTIFIED**

<sup>(1)</sup> Cobalt: glazed porcelain tiles / Cobalt: gres porcellanato smaltato / Cobalt: carreaux en grès cérame émaillé / Cobalt: glasierte Feinsteinzeugfliesen / Cobalt: gres porcelánico esmaltado / Cobalt: глазурованный керамогранит.

INDEX



A COMPLETE PRODUCT SYSTEM



PRODUCT FINDER



SURFACE RANGE



COMPANY



COLLECTIONS



3D WALL  
 CONCRETE & RESIN LOOK  
 METAL LOOK  
 MARBLE LOOK  
 STONE LOOK  
 WOOD LOOK

LARGE SIZES



SLABS FOR COUNTERTOPS & FURNITURE



SINKS & BATHROOM FURNISHING



FACADES



TECHNICAL SPECIFICATIONS



# Boost Natural

## Porcelain Tiles

### DECOR RANGE



A7CN Boost Natural Kaolin Mosaico Rhombus 36,7x33,8 - 14 1/2"x13 1/4"  
 A7CO Boost Natural Ash Mosaico Rhombus 36,7x33,8 - 14 1/2"x13 1/4"  
 A7CP Boost Natural Ecrú Mosaico Rhombus 36,7x33,8 - 14 1/2"x13 1/4"  
 A7CQ Boost Natural Umber Mosaico Rhombus 36,7x33,8 - 14 1/2"x13 1/4"



A7CR Boost Natural Coal Mosaico Rhombus 36,7x33,8 - 14 1/2"x13 1/4"  
 A7CT Boost Natural Coral Mosaico Rhombus 36,7x33,8 - 14 1/2"x13 1/4"  
 A7CS Boost Natural Cobalt Mosaico Rhombus 36,7x33,8 - 14 1/2"x13 1/4"

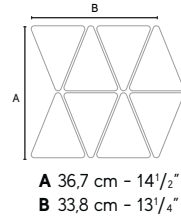

A7CF Boost Natural Kaolin Mosaico Tumbled (1) 31x31 - 12 1/4"x12 1/4"  
 A7CG Boost Natural Ash Mosaico Tumbled (1) 31x31 - 12 1/4"x12 1/4"  
 A7CH Boost Natural Ecrú Mosaico Tumbled (1) 31x31 - 12 1/4"x12 1/4"  
 A7CI Boost Natural Umber Mosaico Tumbled (1) 31x31 - 12 1/4"x12 1/4"  
 A7CJ Boost Natural Coal Mosaico Tumbled (1) 31x31 - 12 1/4"x12 1/4"

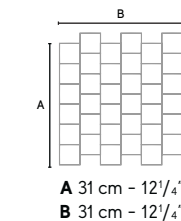

A7CL Boost Natural Coral Mosaico Tumbled (1) 31x31 - 12 1/4"x12 1/4"  
 A7CK Boost Natural Cobalt Mosaico Tumbled (1) 31x31 - 12 1/4"x12 1/4"

### TRIM TILES p. 352

	Battiscopa	Gradino *	Scalino *	Scalino Ang. *	Battiscopa Sag. Scala *	Elemento L	Corner * ± 6 mm	Corner A.E * ± 6 mm				
	7,2x120 cm 2 7/8"x47 1/4" Matte	7,2x60 cm 2 7/8"x23 3/4" Matte	30x120 cm 11 7/8"x47 1/4" Matte	30x60 cm 11 7/8"x23 3/4" Matte	33x120 cm 13"x47 1/4" Matte	33x60 cm 13"x23 3/4" Matte	33x33 cm 13"x13" Matte	7,2x30 cm 2 7/8"x11 7/8" Matte	DX SX	7,2x120 H. 4 cm 13"x47 1/4" H.1 1/2" Grip	1x120 cm 3/8"x47 1/4" Matte	1x1 cm 3/8"x1/4" Matte
Kaolin	A7DV	A7DQ	A7EQ	A7EL	A7IQ	A7IL	A7IX	A7D9	A7D2	A7I4	A7MY	A7M5
Ash	A7DW	A7DR	A7ER	A7EM	A7IR	A7IM	A7IY	A7EA	A7D3	A7I5	A7MZ	A7M6
Ecrú	A7DX	A7DS	A7ES	A7EN	A7IS	A7IN	A7IZ	A7EB	A7D4	A7I6	A7MØ	A7M7
Umber	A7DY	A7DT	A7ET	A7EO	A7IT	A7IO	A7IØ	A7EC	A7D5	A7I7	A7M1	A7M8
Coal	A7DZ	A7DU	A7EU	A7EP	A7IU	A7IP	A7I1	A7ED	A7D6	A7I8	A7M2	A7M9
Cobalt	A7DØ	-	A7EV	-	A7IV	-	A7I2	A7EE	A7D7	-	A7M3	A7NA
Coral	A7D1	-	A7EW	-	A7IW	-	A7I3	A7EF	A7D8	-	A7M4	A7NB

\* These parts are supplied to order - I pezzi sono disponibili su ordinazione - Les pièces sont disponibles sur commande - Die Teile sind auf Bestellung lieferbar - Las piezas se hacen por encargo - Изготавливаются на заказ



© Ceramiche Atlas Concorde

(1) Tumbled. Irregularities in the edges are not defects but rather features intrinsic to this type of product. / Burattato. Le irregolarità del bordo non sono da considerarsi un difetto ma una caratteristica intrinseca di questa tipologia di prodotto. / Tamisé. Les irrégularités des bords ne doivent pas être considérées comme un défaut mais comme une caractéristique intrinsèque de ce type de produit. / Genarbt. Die unregelmäßigen Kanten sind nicht als Fehler zu betrachten; sie sind ein für dieses Produkt charakteristisches Merkmal. / Tamboreado. Las irregularidades de los bordes no deben considerarse un defecto, sino una característica intrínseca de este tipo de productos. / Галтованная мозаика. Неровности граней являются не дефектом, а неотъемлемой характеристикой данного вида изделий.

# Boost Natural

## Wall Tiles

### MATTE SURFACE



± 8.5 mm

50x120 cm - 19 5/8" x 47 1/4"

A64P Boost Natural Kaolin

A64Q Boost Natural Ash

A64R Boost Natural Ecu

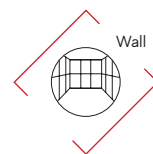

± 8.5 mm 3D WALL

50x120 cm - 19 5/8" x 47 1/4"

A64S Boost Natural 3D Brushed Kaolin

A64T Boost Natural 3D Brushed Ash

A64U Boost Natural 3D Brushed Ecu

A64V Boost Natural 3D Texture Kaolin

A64W Boost Natural 3D Texture Ash

A64X Boost Natural 3D Texture Ecu

A64Y Boost Natural 3D Wave Kaolin

A64Z Boost Natural 3D Wave Ash

A64Ø Boost Natural 3D Wave Ecu

### TRIM TILES



1,4x50 cm - 5/8" x 19 5/8"

A641 Boost Natural Kaolin Corner 50 \*

A642 Boost Natural Ash Corner 50 \*

A643 Boost Natural Ecu Corner 50 \*



1,4x1,4 cm - 5/8" x 5/8"

A644 Boost Natural Kaolin Corner A.E. \*

A645 Boost Natural Ash Corner A.E. \*

A646 Boost Natural Ecu Corner A.E. \*

### 3D TRIM TILES

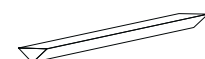

1,4x50 cm - 5/8" x 19 5/8"

A7BN Boost Natural 3D Texture Kaolin Corner 50 \*

A7BO Boost Natural 3D Texture Ash Corner 50 \*

A7BP Boost Natural 3D Texture Ecu Corner 50 \*

A7BQ Boost Natural 3D Brushed Kaolin Corner 50 \*

A7BR Boost Natural 3D Brushed Ash Corner 50 \*

A7BS Boost Natural 3D Brushed Ecu Corner 50 \*

\* These parts are supplied to order - I pezzi sono disponibili su ordinazione  
Les pièces sont disponibles sur commande - Die Teile sind auf Bestellung lieferbar  
Las piezas se hacen por encargo - Изготавливаются на заказ



### DECOR RANGE



AHVH Boost Natural Kaolin  
Mosaico Piano <sup>(1)</sup>  
50x40,5 - 19 5/8" x 16"

AHHF Boost Natural Ash  
Mosaico Piano <sup>(1)</sup>  
50x40,5 - 19 5/8" x 16"

AHHG Boost Natural Ecu  
Mosaico Piano <sup>(1)</sup>  
50x40,5 - 19 5/8" x 16"

AHHH Boost Natural Kaolin  
Mosaico Piano Mix <sup>(1)</sup>  
50x40,5 - 19 5/8" x 16"

AHHI Boost Natural Ash  
Mosaico Piano Mix <sup>(1)</sup>  
50x40,5 - 19 5/8" x 16"

AHHJ Boost Natural Ecu  
Mosaico Piano Mix <sup>(1)</sup>  
50x40,5 - 19 5/8" x 16"

AHHK Boost Natural Kaolin  
Mosaico Trace Mix  
30x29,2 - 11 1/4" x 11 1/2"

AHHL Boost Natural Ash  
Mosaico Trace Mix  
30x29,2 - 11 1/4" x 11 1/2"

AHHM Boost Natural Ecu  
Mosaico Trace Mix  
30x29,2 - 11 1/4" x 11 1/2"

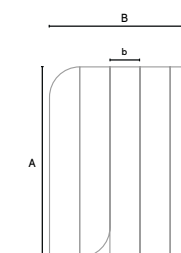

A 50 cm - 19 5/8"  
b 7,95 cm - 3 1/8"  
B 40,4 cm - 15 7/8"

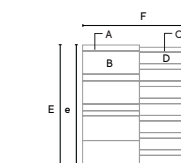

A 14,5x1,3 cm - 5 3/4" x 1/2"  
B 14,5x5,9 cm - 5 3/4" x 2 3/4"  
C 14,5x1 cm - 5 3/4" x 1/8"  
D 14,5x3 cm - 5 3/4" x 1 1/8"  
E 30,7 cm - 12 1/8"  
e 30 cm - 11 7/8"  
F 29,1 cm - 11 1/2"

<sup>(1)</sup> For the best performance of the mosaic we recommend the use of epoxy mortars (class RG - EN 13888/ISO 13007) or decorative resins-cement, following the manufacturer's instructions. - Al fine di ottenere una resa ottimale del mosaico, è consigliato l'utilizzo di malte epossidiche (classe RG - EN 13888/ISO 13007) o di resine cementizie attenendosi alle indicazioni di utilizzo fornite dal produttore. - Afin d'obtenir un rendu optimal de la mosaïque, nous vous conseillons d'utiliser des mortiers époxy (classe RG - EN 13888/ISO 13007) ou des résines à base de ciment, en suivant les indications d'utilisation fournies par le fabricant. - Um das Mosaik optimal zur Geltung zu bringen, empfehlen wir die Verwendung von Epoxidharzfugenmörtel (Klasse RG - EN 13888/ISO 13007) oder von vergüteten Fugenmörteln unter Beachtung der vom Hersteller angegebenen Verwendungshinweise. - Para obtener un rendimiento óptimo del mosaico, se aconseja utilizar mortero epoxi (clase RG - EN 13888/ISO 13007) o resinas de cemento siguiendo las indicaciones entregadas por el fabricante. - Для наилучшего эстетического результата при укладке мозаики рекомендуется использовать эпоксидные растворы (класс RG - EN 13888/ISO 13007) или полимерцемент, соблюдая инструкции производителя.

INDEX



A COMPLETE  
PRODUCT  
SYSTEM



PRODUCT  
FINDER



SURFACE  
RANGE



COMPANY



COLLECTIONS



3D WALL  
CONCRETE & RESIN LOOK  
METAL LOOK  
MARBLE LOOK  
STONE LOOK  
WOOD LOOK

LARGE SIZES



SLABS FOR  
COUNTERTOPS  
& FURNITURE



SINKS &  
BATHROOM  
FURNISHING



FACADES



TECHNICAL  
SPECIFICATIONS



# Boost Pro

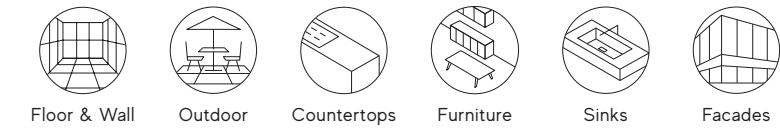

© Ceramiche Atlas Concorde



© Ceramiche Atlas Concorde



© Ceramiche Atlas Concorde



**Porcelain Tiles** RECTIFIED MONOCALIBER

Sizes	Thickness	Surface finish
160x160 cm - 63"x63"	± 6 mm	Matte <b>R9 A</b>
120x278 cm - 47 1/4"x109 1/2"	± 6 mm	Matte <b>R9 A</b>
120x240 cm - 47 1/4"x94 1/2"	± 9 mm	Matte <b>R10 B</b>
120x120 cm - 47 1/4"x47 1/4"	± 6 mm	Matte <b>R9 A</b>
	± 9 mm	Matte <b>Sensitech R10 B</b>
60x120 cm - 23 5/8"x47 1/4"	± 9 mm	Matte <b>Sensitech R10 B</b>
75x150 cm - 29 1/2"x59"	± 9 mm	Matte <b>Sensitech R10 B</b>
75x75 cm - 29 1/2"x29 1/2"	± 9 mm	Matte <b>Sensitech R10 B</b>
60x60 cm - 23 5/8"x23 5/8"	± 9 mm	Matte <b>Sensitech R10 B</b>
30x60 cm - 11 3/4"x23 5/8"	± 9 mm	Matte <b>Sensitech R10 B</b>

LARGE SIZES P. 356

**OUTDOOR AND WET AREAS**

120x120 cm - 47 1/4"x47 1/4"	± 9 mm	Grip <b>R11 C</b>
120x120 cm - 47 1/4"x47 1/4"	± 20 mm	Outdoor <b>R11 C</b>
60x120 cm - 23 5/8"x47 1/4"	± 20 mm	Outdoor <b>R11 C</b>
90x90 cm - 35 3/8"x35 3/8"	± 20 mm	Outdoor <b>R11 C</b>
60x60 cm - 23 5/8"x23 5/8"	± 20 mm	Outdoor <b>R11 C</b>

**atlasPLAN**

160x320 cm - 63"x126"	± 6 mm	Hammered <b>R9 A</b>
-----------------------	--------	----------------------



**Wall Tiles** RECTIFIED MONOCALIBER

Sizes	Thickness	Surface finish
40x80 cm - 15 3/4"x31 1/2"	± 8,5 mm	Matte
<b>3D WALL TILES</b>		
40x80 cm - 15 3/4"x31 1/2"	± 10 mm	Matte

INDEX

A COMPLETE PRODUCT SYSTEM

PRODUCT FINDER

SURFACE RANGE

COMPANY

COLLECTIONS

- 3D WALL
- CONCRETE & RESIN LOOK
- METAL LOOK
- MARBLE LOOK
- STONE LOOK
- WOOD LOOK

LARGE SIZES

SLABS FOR COUNTERTOPS & FURNITURE

SINKS & BATHROOM FURNISHING

FACADES

TECHNICAL SPECIFICATIONS

# Boost Pro

## Porcelain Tiles

**M** MEDIUM TRAFFIC Matte ± 6 mm

**H** HEAVY TRAFFIC Matte ± 9 mm Grip ± 9 mm Outdoor ± 20 mm

**R9 A** Matte ± 6 mm **R10 B** Matte ± 9 mm **R10 B** Matte Sensitech (S) ± 9 mm **R11 C** Grip ± 9 mm **R11 C** Outdoor ± 20 mm

**V3** Moderate Variation



### MATTE SURFACE



± 6 mm  
**160x320 cm** - 63"x126"  
 AØQE Boost Pro Clay Hammered  
 AØQF Boost Pro Taupe Hammered

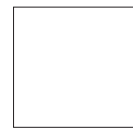

± 6 mm  
**160x160 cm** - 63"x63"  
 AØQG Boost Pro Clay  
 AØQH Boost Pro Taupe

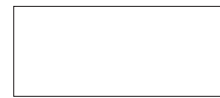

± 6 mm  
**120x278 cm** - 47 1/4"x109 1/2"  
 AØCK Boost Pro Ivory  
 AØCM Boost Pro Cream  
 AØCN Boost Pro Clay  
 AØCO Boost Pro Taupe  
 AØCP Boost Pro Tobacco



± 6 mm  
**120x120 cm** - 47 1/4"x47 1/4"  
 AØCQ Boost Pro Ivory  
 AØCR Boost Pro Cream  
 AØCS Boost Pro Clay  
 AØCT Boost Pro Taupe  
 AØCU Boost Pro Tobacco



± 9 mm  
**120x240 cm** - 47 1/4"x94 1/2"  
 AØCF Boost Pro Ivory  
 AØCG Boost Pro Cream  
 AØCJ Boost Pro Clay  
 AØCH Boost Pro Taupe  
 AØCI Boost Pro Tobacco



± 9 mm (S)  
**120x120 cm** - 47 1/4"x47 1/4"  
 AØAF Boost Pro Ivory  
 AØAH Boost Pro Cream  
 AØAJ Boost Pro Clay  
 AØAL Boost Pro Taupe  
 AØAN Boost Pro Tobacco



± 9 mm (S)  
**60x120 cm** - 23 5/8"x47 1/4"  
 AØBY Boost Pro Ivory  
 AØBZ Boost Pro Cream  
 AØBØ Boost Pro Clay  
 AØB8 Boost Pro Taupe  
 AØB9 Boost Pro Tobacco



± 9 mm (S)  
**60x60 cm** - 23 5/8"x23 5/8"  
 AØC3 Boost Pro Ivory  
 AØB4 Boost Pro Cream  
 AØC5 Boost Pro Clay  
 AØC6 Boost Pro Taupe  
 AØC7 Boost Pro Tobacco



± 9 mm (S)  
**30x60 cm** - 11 3/4"x23 5/8"  
 AØC8 Boost Pro Ivory  
 AØC9 Boost Pro Cream  
 AØDA Boost Pro Clay  
 AØDB Boost Pro Taupe  
 AØDC Boost Pro Tobacco



± 9 mm (S)  
**75x150 cm** - 29 1/2"x59"  
 A7GØ Boost Pro Ivory  
 A7G2 Boost Pro Cream  
 A7G3 Boost Pro Clay  
 A7G4 Boost Pro Taupe  
 A7G1 Boost Pro Tobacco

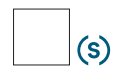

± 9 mm (S)  
**75x75 cm** - 29 1/2"x29 1/2"  
 A28F Boost Pro Ivory  
 A28G Boost Pro Cream  
 A28H Boost Pro Clay  
 A28I Boost Pro Taupe  
 A28J Boost Pro Tobacco

### GRIP SURFACE



± 9 mm  
**120x120 cm** - 47 1/4"x47 1/4"  
 AØAO Boost Pro Ivory Grip  
 AØAQ Boost Pro Cream Grip  
 AØBV Boost Pro Clay Grip  
 AØBW Boost Pro Taupe Grip  
 AØBX Boost Pro Tobacco Grip



± 20 mm  
**120x120 cm** - 47 1/4"x47 1/4"  
 A3DD Boost Pro Cream 20 mm  
 A3DE Boost Pro Clay 20 mm  
 A3DF Boost Pro Taupe 20 mm  
 A3DH Boost Pro Tobacco 20 mm



± 20 mm  
**60x120 cm** - 23 5/8"x47 1/4"  
 A4XU Boost Pro Cream 20 mm  
 A4XV Boost Pro Clay 20 mm  
 A4XW Boost Pro Taupe 20 mm  
 A4XX Boost Pro Tobacco 20 mm



± 20 mm  
**60x60 cm** - 23 5/8"x23 5/8"  
 A4XQ Boost Pro Cream 20 mm  
 A4XR Boost Pro Clay 20 mm  
 A4XS Boost Pro Taupe 20 mm  
 A4XT Boost Pro Tobacco 20 mm



± 20 mm  
**90x90 cm** - 35 3/8"x35 3/8"  
 A4XM Boost Pro Cream 20 mm  
 A4XN Boost Pro Clay 20 mm  
 A4XO Boost Pro Taupe 20 mm  
 A4XP Boost Pro Tobacco 20 mm

### COMPLETE YOUR PROJECT

Countertops P.402  
 Furniture P.356  
 Sinks P.412  
 Facades P.436

162x324 cm  
 NON-RECTIFIED

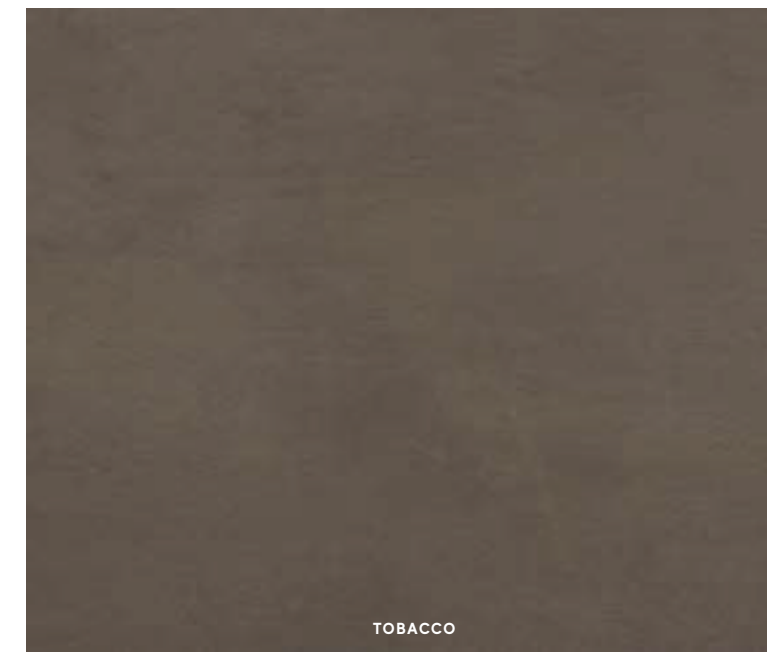
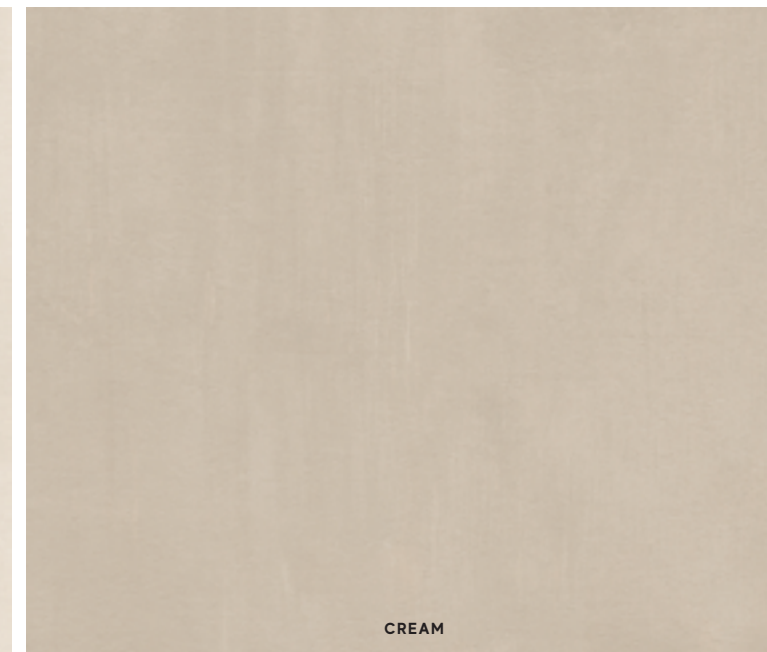

- INDEX
- A COMPLETE PRODUCT SYSTEM
- PRODUCT FINDER
- SURFACE RANGE
- COMPANY
- COLLECTIONS
  - 3D WALL
  - CONCRETE & RESIN LOOK
  - METAL LOOK
  - MARBLE LOOK
  - STONE LOOK
  - WOOD LOOK
- LARGE SIZES
- SLABS FOR COUNTERTOPS & FURNITURE
- SINKS & BATHROOM FURNISHING
- FACADES
- TECHNICAL SPECIFICATIONS





# Boost Pro

## Wall Tiles



### MATTE SURFACE

  $\pm 8,5 \text{ mm}$   
**40x80 cm** -  $15\frac{3}{4} \times 31\frac{1}{2} \text{''}$   
 8B8I Boost Pro Ivory  
 8B8E Boost Pro Cream  
 8B8C Boost Pro Clay  
 8B8M Boost Pro Mustard  
 8B8B Boost Pro Powder Blue

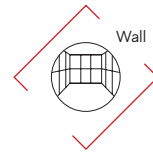

  $\pm 10 \text{ mm 3D WALL}$   
**40x80 cm** -  $15\frac{3}{4} \times 31\frac{1}{2} \text{''}$   
 8BUI Boost Pro 3D Urban Ivory  
 8BUC Boost Pro 3D Urban Clay  
 8BUB Boost Pro 3D Urban Powder Blue



### TRIM TILES

  
**1,4x40 cm** -  $\frac{5}{8} \times 15\frac{3}{4} \text{''}$   
 LBBI Boost Pro Ivory Corner 40 \*  
 LBBM Boost Pro Cream Corner 40 \*  
 LBBA Boost Pro Clay Corner 40 \*  
 LBBU Boost Pro Mustard Corner 40 \*  
 LBBG Boost Pro Powder Blue Corner 40 \*

  
**1,4x1,4 cm** -  $\frac{5}{8} \times \frac{5}{8} \text{''}$   
 AØAI Boost Pro Ivory Corner A.E. \*  
 AØAE Boost Pro Cream Corner A.E. \*  
 AØAC Boost Pro Clay Corner A.E. \*  
 AØAM Boost Pro Mustard Corner A.E. \*  
 AØAB Boost Pro Powder Blue Corner A.E. \*

### 3D TRIM TILES

  
**1,4x40 cm** -  $\frac{5}{8} \times 15\frac{3}{4} \text{''}$   
 LB3I Boost Pro Ivory 3D Corner 40 \*  
 LB3C Boost Pro Clay 3D Corner 40 \*  
 LB3B Boost Pro Powder Blue 3D Corner 40 \*

\* These parts are supplied to order - I pezzi sono disponibili su ordinazione - Les pièces sont disponibles sur commande - Die Teile sind auf Bestellung lieferbar - Las piezas se hacen por encargo - Изготавливаются на заказ

<sup>(1)</sup> Application of decorative materials. The use of a common mild detergent is recommended. Avoid using acidic or alkaline products, waxes, steel wool or abrasives. - Applicazione di materie decorative. Si consiglia l'utilizzo di un comune detergente neutro. Evitare l'utilizzo di prodotti acidi o alcalini, ceranti e pagliette di metallo o abrasive. - Application de matériaux décoratifs. Nous conseillons l'emploi de détergents neutres courants. Éviter l'utilisation de cires et de produits acides ou alcalins, ainsi que les pâilles métalliques ou abrasives. - Dekorationsmaterial. Es empfiehlt sich, ein haushaltsübliches, neutrales Reinigungsmittel zu verwenden. Saure oder alkalische Produkte, Wachs sowie Stahlwolle- bzw. Scheuerschwämme sind zu vermeiden. Aplicación de materiales decorativos. Recomendamos utilizar un detergente neutro común. Hay que evitar el uso de productos ácidos o alcalinos, ceras y estropajos de metal o abrasivos. - Применение декоративных материалов. Рекомендуется чистить обычным нейтральным моющим средством. Не рекомендуется использовать кислотные, щелочные, восковые средства, а также металлические мочалки.

### DECOR RANGE



9B8I Boost Pro Ivory  
 Minibrick Pro Olive <sup>(1)</sup>  
 29,7x33,3 -  $11\frac{5}{8} \times 13\frac{1}{4} \text{''}$



9BMV Boost Pro Cream  
 Minibrick Pro Blue <sup>(1)</sup>  
 29,7x33,3 -  $11\frac{5}{8} \times 13\frac{1}{4} \text{''}$



9BMZ Boost Pro Clay  
 Minibrick Pro Coffee <sup>(1)</sup>  
 29,7x33,3 -  $11\frac{5}{8} \times 13\frac{1}{4} \text{''}$

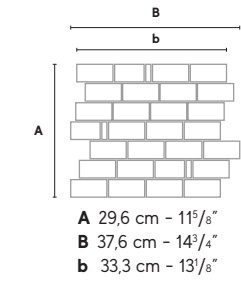

9BMT Boost Pro Mustard  
 Minibrick Pro Yellow <sup>(1)</sup>  
 29,7x33,3 -  $11\frac{5}{8} \times 13\frac{1}{4} \text{''}$



9BMU Boost Pro Powder Blue  
 Minibrick Pro Ocean <sup>(1)</sup>  
 29,7x33,3 -  $11\frac{5}{8} \times 13\frac{1}{4} \text{''}$



© Ceramiche Atlas Concorde

INDEX



A COMPLETE PRODUCT SYSTEM



PRODUCT FINDER



SURFACE RANGE



COMPANY



COLLECTIONS



3D WALL  
 CONCRETE & RESIN LOOK  
 METAL LOOK  
 MARBLE LOOK  
 STONE LOOK  
 WOOD LOOK

LARGE SIZES



SLABS FOR COUNTERTOPS & FURNITURE



SINKS & BATHROOM FURNISHING



FACADES



TECHNICAL SPECIFICATIONS



# Dwell



© Ceramiche Atlas Concorde



© Ceramiche Atlas Concorde



© Ceramiche Atlas Concorde

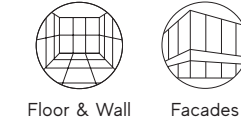

Floor & Wall

Facades

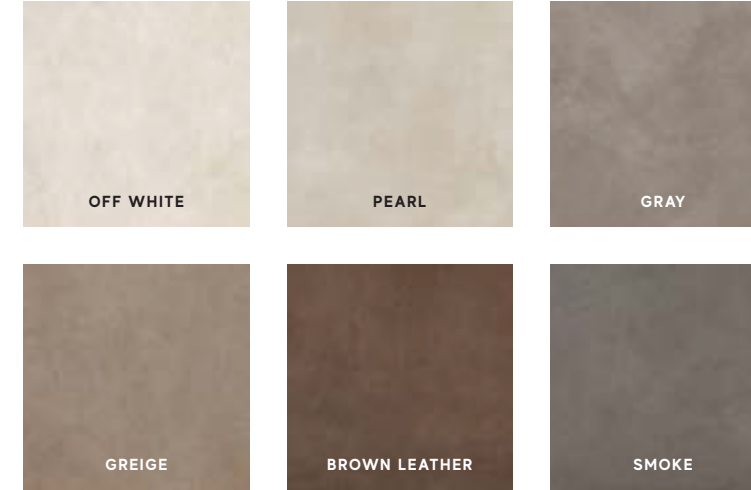

## Porcelain Tiles RECTIFIED MONOCALIBER

Sizes	Thickness	Surface finish
120x120 cm - 47 1/4" x 47 1/4"	± 9 mm	Matte R9 A
60x60 cm - 23 5/8" x 23 5/8"	± 9 mm	Matte R9 A

INDEX

A COMPLETE PRODUCT SYSTEM

PRODUCT FINDER

SURFACE RANGE

COMPANY

COLLECTIONS

- 3D WALL
- CONCRETE & RESIN LOOK
- METAL LOOK
- MARBLE LOOK
- STONE LOOK
- WOOD LOOK

LARGE SIZES

SLABS FOR COUNTERTOPS & FURNITURE

SINKS & BATHROOM FURNISHING

FACADES

TECHNICAL SPECIFICATIONS

# Dwell

## Porcelain Tiles

### MATTE SURFACE

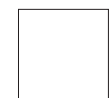

± 9 mm  
**120x120 cm** - 47<sup>1</sup>/<sub>4</sub>"x47<sup>1</sup>/<sub>4</sub>"  
 A1QJ Dwell Off White  
 A1QK Dwell Gray  
 A1QL Dwell Greige  
 A1QM Dwell Smoke



± 9 mm  
**60x60 cm** - 23<sup>5</sup>/<sub>8</sub>"x23<sup>5</sup>/<sub>8</sub>"  
 AW8Y Dwell Off White  
 AW8Z Dwell Pearl  
 AW8Ø Dwell Gray  
 AW81 Dwell Greige  
 AW82 Dwell Brown Leather  
 AW83 Dwell Smoke



Matte ± 9 mm



R9 A Matte ± 9 mm



V2 Slight Variation



Floor & Wall

### COMPLETE YOUR PROJECT



Facades  
 P.436

### DECOR RANGE



A1CX Dwell Off White Mosaico 30x30 - 11<sup>3</sup>/<sub>4</sub>"x11<sup>3</sup>/<sub>4</sub>"  
 A1CY Dwell Pearl Mosaico 30x30 - 11<sup>3</sup>/<sub>4</sub>"x11<sup>3</sup>/<sub>4</sub>"  
 A1CZ Dwell Gray Mosaico 30x30 - 11<sup>3</sup>/<sub>4</sub>"x11<sup>3</sup>/<sub>4</sub>"  
 A1CØ Dwell Greige Mosaico 30x30 - 11<sup>3</sup>/<sub>4</sub>"x11<sup>3</sup>/<sub>4</sub>"  
 A1C1 Dwell Brown Leather Mosaico 30x30 - 11<sup>3</sup>/<sub>4</sub>"x11<sup>3</sup>/<sub>4</sub>"  
 A1C2 Dwell Smoke Mosaico 30x30 - 11<sup>3</sup>/<sub>4</sub>"x11<sup>3</sup>/<sub>4</sub>"

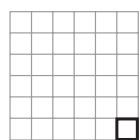

4.8x4.8 cm  
 1<sup>7</sup>/<sub>8</sub>"x1<sup>7</sup>/<sub>8</sub>"



A1C9 Dwell Off White Herringbone 36,2x41,2 - 14<sup>1</sup>/<sub>8</sub>"x16<sup>1</sup>/<sub>8</sub>"  
 A1DA Dwell Pearl Herringbone 36,2x41,2 - 14<sup>1</sup>/<sub>8</sub>"x16<sup>1</sup>/<sub>8</sub>"  
 A1DC Dwell Gray Herringbone 36,2x41,2 - 14<sup>1</sup>/<sub>8</sub>"x16<sup>1</sup>/<sub>8</sub>"



A1DD Dwell Greige Herringbone 36,2x41,2 - 14<sup>1</sup>/<sub>8</sub>"x16<sup>1</sup>/<sub>8</sub>"  
 A1DE Dwell Brown Leather Herringbone 36,2x41,2 - 14<sup>1</sup>/<sub>8</sub>"x16<sup>1</sup>/<sub>8</sub>"  
 A1DF Dwell Smoke Herringbone 36,2x41,2 - 14<sup>1</sup>/<sub>8</sub>"x16<sup>1</sup>/<sub>8</sub>"

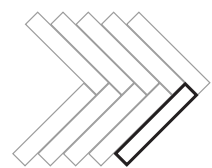

4.9x29 cm  
 1<sup>7</sup>/<sub>8</sub>"x11<sup>3</sup>/<sub>8</sub>"

### TRIM TILES

p. 352

#### Battiscopa

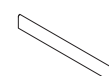

7,2x60 cm  
 2<sup>7</sup>/<sub>8</sub>"x23<sup>5</sup>/<sub>8</sub>"  
 Matte

#### Scalino \*

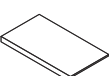

33x60 cm  
 13"x23<sup>5</sup>/<sub>8</sub>"  
 Matte

#### Scalino Ang. \*



33x33 cm  
 13"x13"  
 Matte

#### Battiscopa Sag. Scala \*



7,2x30 cm  
 2<sup>7</sup>/<sub>8</sub>"x11<sup>3</sup>/<sub>4</sub>"  
 Matte

Off White  
 Pearl  
 Gray  
 Greige  
 Brown Leather  
 Smoke

A1E8  
 A1E9  
 A1FC  
 A1FD  
 A1FE  
 A1FF

A1KW  
 A1KX  
 A1KY  
 A1KZ  
 A1KØ  
 A1K1

DX  
 A1K8  
 A1K9  
 A1LA  
 A1LB  
 A1LC  
 A1LD

SX  
 A1K2  
 A1K3  
 A1K4  
 A1K5  
 A1K6  
 A1K7

DX  
 A1LK  
 A1LL  
 A1LM  
 A1LN  
 A1LO  
 A1LP

SX  
 A1LE  
 A1LF  
 A1LG  
 A1LH  
 A1LI  
 A1LJ

\* These parts are supplied to order - I pezzi sono disponibili su ordinazione - Les pièces sont disponibles sur commande - Die Teile sind auf Bestellung lieferbar - Las piezas se hacen por encargo - Изготавливаются на заказ



INDEX



A COMPLETE PRODUCT SYSTEM



PRODUCT FINDER



SURFACE RANGE



COMPANY



COLLECTIONS



3D WALL  
 CONCRETE & RESIN LOOK  
 METAL LOOK  
 MARBLE LOOK  
 STONE LOOK  
 WOOD LOOK

LARGE SIZES



SLABS FOR COUNTERTOPS & FURNITURE



SINKS & BATHROOM FURNISHING



FACADES



TECHNICAL SPECIFICATIONS



# Prism

A color concept by **Piero Lissoni**



© Ceramiche Atlas Concorde



© Ceramiche Atlas Concorde



© Ceramiche Atlas Concorde

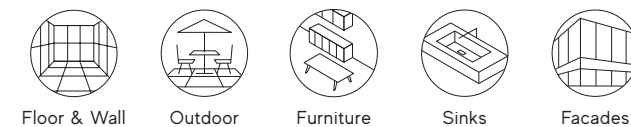

## Porcelain Tiles RECTIFIED MONOCALIBER

Sizes	Thickness	Surface finish
120x278 cm - 47 <sup>1</sup> / <sub>4</sub> "x109 <sup>1</sup> / <sub>2</sub> "	± 6 mm	Matte <b>R9 A</b>
120x120 cm - 47 <sup>1</sup> / <sub>4</sub> "x47 <sup>1</sup> / <sub>4</sub> "	± 9 mm	Silk   Matte <b>Sensitech R10 B</b>
60x120 cm - 23 <sup>3</sup> / <sub>8</sub> "x47 <sup>1</sup> / <sub>4</sub> "	± 9 mm	Matte <b>Sensitech R10 B</b>
60x60 cm - 23 <sup>3</sup> / <sub>8</sub> "x23 <sup>3</sup> / <sub>8</sub> "	± 9 mm	Silk   Matte <b>Sensitech R10 B</b>
30x60 cm - 11 <sup>1</sup> / <sub>4</sub> "x23 <sup>3</sup> / <sub>8</sub> "	± 9 mm	Silk   Matte <b>Sensitech R10 B</b>

LARGE SIZES P. 356

### OUTDOOR AND WET AREAS

Sizes	Thickness	Surface finish
120x120 cm - 47 <sup>1</sup> / <sub>4</sub> "x47 <sup>1</sup> / <sub>4</sub> "	± 9 mm	Grip <b>R11 C</b>
120x120 cm - 47 <sup>1</sup> / <sub>4</sub> "x47 <sup>1</sup> / <sub>4</sub> "	± 20 mm	Outdoor <b>R11 C</b>
80x80 cm - 31 <sup>1</sup> / <sub>2</sub> "x31 <sup>1</sup> / <sub>2</sub> "	± 20 mm	Outdoor <b>R11 C</b>

## Glazed Porcelain Tiles RECTIFIED MONOCALIBER

Sizes	Thickness	Surface finish
120x278 cm - 47 <sup>1</sup> / <sub>4</sub> "x109 <sup>1</sup> / <sub>2</sub> "	± 6 mm	Matte



## Wall Tiles RECTIFIED MONOCALIBER

Sizes	Thickness	Surface finish
50x120 cm - 19 <sup>3</sup> / <sub>8</sub> "x47 <sup>1</sup> / <sub>4</sub> "	± 8,5 mm	Matte

INDEX



A COMPLETE PRODUCT SYSTEM >

PRODUCT FINDER >

SURFACE RANGE >

COMPANY >

COLLECTIONS >

- 3D WALL
- CONCRETE & RESIN LOOK
- METAL LOOK
- MARBLE LOOK
- STONE LOOK
- WOOD LOOK

LARGE SIZES >

SLABS FOR COUNTERTOPS & FURNITURE >

SINKS & BATHROOM FURNISHING >

FACADES >

TECHNICAL SPECIFICATIONS >

# Prism

## Porcelain Tiles

### MATTE SURFACE



**± 6 mm**  
**120x278 cm** - 47<sup>1</sup>/<sub>4</sub>"x109<sup>1</sup>/<sub>2</sub>"  
 A4UP Prism Suede  
 A4UQ Prism Cord  
 A4UR Prism Cotton  
 A4US Prism Cloud  
 A4UT Prism Fog  
 A4UU Prism Graphite



**± 9 mm**  
**120x120 cm** - 47<sup>1</sup>/<sub>4</sub>"x47<sup>1</sup>/<sub>4</sub>"  
 A4OG Prism Suede  
 A4OH Prism Cord  
 A4OI Prism Cotton  
 A4OJ Prism Cloud  
 A4OK Prism Fog  
 A4OL Prism Graphite

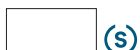

**± 9 mm**  
**60x120 cm** - 23<sup>5</sup>/<sub>8</sub>"x47<sup>1</sup>/<sub>4</sub>"  
 A4OS Prism Suede  
 A4OT Prism Cord  
 A4OU Prism Cotton  
 A4OV Prism Cloud  
 A4OW Prism Fog  
 A4OX Prism Graphite



**± 9 mm**  
**60x60 cm** - 23<sup>5</sup>/<sub>8</sub>"x23<sup>5</sup>/<sub>8</sub>"  
 A4UV Prism Suede  
 A4UW Prism Cord  
 A4UX Prism Cotton  
 A4UY Prism Cloud  
 A4UZ Prism Fog  
 A4UØ Prism Graphite



**± 9 mm**  
**30x60 cm** - 11<sup>3</sup>/<sub>4</sub>"x23<sup>5</sup>/<sub>8</sub>"  
 A4U1 Prism Suede  
 A4U2 Prism Cord  
 A4U3 Prism Cotton  
 A4U4 Prism Cloud  
 A4U5 Prism Fog  
 A4U6 Prism Graphite



Matte ± 6 mm  
 Silk ± 9 mm



Matte ± 9 mm  
 Grip ± 9 mm  
 Outdoor ± 20 mm



R9 A Matte ± 6 mm  
 R10 B Matte Sensitech (S) ± 9 mm  
 R11 C Grip ± 9 mm  
 R11 C Outdoor ± 20 mm



V2 Slight  
 Variation



### SILK SURFACE



**± 9 mm**  
**120x120 cm** - 47<sup>1</sup>/<sub>4</sub>"x47<sup>1</sup>/<sub>4</sub>"  
 A4OM Prism Suede Silk  
 A4ON Prism Cord Silk  
 A4OO Prism Cotton Silk  
 A4OP Prism Cloud Silk  
 A4OQ Prism Fog Silk  
 A4OR Prism Graphite Silk



**± 9 mm**  
**60x60 cm** - 23<sup>5</sup>/<sub>8</sub>"x23<sup>5</sup>/<sub>8</sub>"  
 A5RV Prism Suede Silk  
 A5RW Prism Cord Silk  
 A5RX Prism Cotton Silk  
 A5RY Prism Cloud Silk  
 A5RZ Prism Fog Silk  
 A5RØ Prism Graphite Silk



**± 9 mm**  
**30x60 cm** - 11<sup>3</sup>/<sub>4</sub>"x23<sup>5</sup>/<sub>8</sub>"  
 A5R2 Prism Suede Silk  
 A5R6 Prism Cord Silk  
 A5R7 Prism Cotton Silk  
 A5SA Prism Cloud Silk  
 A5SB Prism Fog Silk  
 A5SC Prism Graphite Silk

### GRIP SURFACE



**± 9 mm**  
**120x120 cm** - 47<sup>1</sup>/<sub>4</sub>"x47<sup>1</sup>/<sub>4</sub>"  
 A5OI Prism Suede Grip  
 A5OJ Prism Cord Grip  
 A5OK Prism Cloud Grip  
 A5OL Prism Fog Grip



**± 20 mm**  
**120x120 cm** - 47<sup>1</sup>/<sub>4</sub>"x47<sup>1</sup>/<sub>4</sub>"  
 A5OM Prism Suede 20 mm  
 A5ON Prism Cord 20 mm  
 A5OO Prism Cloud 20 mm  
 A5OP Prism Fog 20 mm



**± 20 mm**  
**80x80 cm** - 31<sup>1</sup>/<sub>2</sub>"x31<sup>1</sup>/<sub>2</sub>"  
 A56H Prism Suede 20 mm  
 A56I Prism Cord 20 mm  
 A56J Prism Cloud 20 mm  
 A56K Prism Fog 20 mm



## Glazed Porcelain Tiles

### MATTE SURFACE



**± 6 mm**  
**120x278 cm** - 47<sup>1</sup>/<sub>4</sub>"x109<sup>1</sup>/<sub>2</sub>"<sup>(1)</sup>  
 A4VH Prism Bloom  
 A4VI Prism Caramel  
 A4VJ Prism Grape  
 A4VK Prism Dusk  
 A4VL Prism Midnight  
 A4VM Prism Moss  
 A4VN Prism Emerald

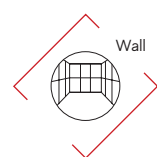

<sup>(1)</sup> The use of a common mild detergent is recommended. Avoid using acidic or alkaline products, waxes, steel wool, or abrasives. - Si consiglia l'utilizzo di un comune detergente neutro. Evitare l'utilizzo di prodotti acidi o alcalini, ceranti, pagliette di metallo o abrasive. - Nous vous conseillons d'utiliser des détergents neutres courants. Éviter l'utilisation de cires et de produits acides ou alcalins, ainsi que les pailles métalliques ou abrasives. - Es empfiehlt sich, ein haushaltsübliches, neutrales Reinigungsmittel zu verwenden. Saure oder alkalische Produkte, Wachs sowie Metallwolle- bzw. Scheuerschwämme sind zu vermeiden. - Recomendamos utilizar un detergente neutro común. Hay que evitar el uso de productos ácidos o alcalinos, ceras y estropajos de metal o abrasivos. - Рекомендуется чистить обычным нейтральным моющим средством. Не рекомендуется использовать кислотные, щелочные, восковые средства, а также металлические мошники.

### COMPLETE YOUR PROJECT



Furniture  
 P.356



Sinks  
 P.412



Facades  
 P.436



INDEX



A COMPLETE  
 PRODUCT  
 SYSTEM



PRODUCT  
 FINDER



SURFACE  
 RANGE



COMPANY



COLLECTIONS



3D WALL  
 CONCRETE & RESIN LOOK  
 METAL LOOK  
 MARBLE LOOK  
 STONE LOOK  
 WOOD LOOK

LARGE SIZES



SLABS FOR  
 COUNTERTOPS  
 & FURNITURE



SINKS &  
 BATHROOM  
 FURNISHING



FACADES



TECHNICAL  
 SPECIFICATIONS



# Prism

## Porcelain Tiles

### DECOR RANGE

4,8x4,8 cm  
1 7/8" x 1 7/8"

**A** 44,6 cm - 17 1/2"  
**B** 31 cm - 12 1/4"  
**a** 35,7 cm - 14"  
**b** 7,6 cm - 3"  
**c** 8,8 cm - 3 1/2"  
**d** 17,6 cm - 6 7/8"

**A4V1 Prism Cotton**  
Mosaico Matte  
30x30 - 1 1/4" x 1 1/4"

**A4VØ Prism Cord**  
Mosaico Matte  
30x30 - 1 1/4" x 1 1/4"

**A4VZ Prism Suede**  
Mosaico Matte  
30x30 - 1 1/4" x 1 1/4"

**A4V2 Prism Cloud**  
Mosaico Matte  
30x30 - 1 1/4" x 1 1/4"

**A4V3 Prism Fog**  
Mosaico Matte  
30x30 - 1 1/4" x 1 1/4"

**A4V4 Prism Graphite**  
Mosaico Matte  
30x30 - 1 1/4" x 1 1/4"

**A41S Prism Cotton**  
Mosaico Maze  
31x35,7 - 12 1/4" x 14"

**A41R Prism Cord**  
Mosaico Maze  
31x35,7 - 12 1/4" x 14"

**A41Q Prism Suede**  
Mosaico Maze  
31x35,7 - 12 1/4" x 14"

**A41T Prism Cloud**  
Mosaico Maze  
31x35,7 - 12 1/4" x 14"

**A41U Prism Fog**  
Mosaico Maze  
31x35,7 - 12 1/4" x 14"

**A41V Prism Graphite**  
Mosaico Maze  
31x35,7 - 12 1/4" x 14"

**A41Y Prism Cotton**  
Mosaico Maze Silk  
31x35,7 - 12 1/4" x 14"

**A41X Prism Cord**  
Mosaico Maze Silk  
31x35,7 - 12 1/4" x 14"

**A41W Prism Suede**  
Mosaico Maze Silk  
31x35,7 - 12 1/4" x 14"

**A41Z Prism Cloud**  
Mosaico Maze Silk  
31x35,7 - 12 1/4" x 14"

**A411 Prism Fog**  
Mosaico Maze Silk  
31x35,7 - 12 1/4" x 14"

**A412 Prism Graphite**  
Mosaico Maze Silk  
31x35,7 - 12 1/4" x 14"

**A4VO Prism Gradient XL** <sup>(1) (2)</sup>  
120x278 cm - 47 1/4" x 109 1/2"

**A4VP Prism Brush XL** <sup>(1) (2)</sup>  
120x278 cm - 47 1/4" x 109 1/2"

<sup>(1)</sup> The production process does not guarantee the presence of the exact sequence of the graphics inside the packaging - Il processo produttivo non garantisce la presenza dell'esatta sequenza delle grafiche all'interno dell'imballo. - Le processus de fabrication ne garantit pas la présence de la séquence exacte des graphiques à l'intérieur de l'emballage. - Der Produktionsprozess garantiert nicht die exakte Sequenz der Grafiken in der Verpackung. - El proceso de producción no garantiza la presencia de la secuencia exacta de los gráficos dentro del embalaje. - Процесс производства не обеспечивает наличие точно совпадающих рисунков поверхности внутри упаковки.

<sup>(2)</sup> The use of a common mild detergent is recommended. Avoid using acidic or alkaline products, waxes, steel wool, or abrasives. - Si consiglia l'utilizzo di un comune detergente neutro. Evitare l'utilizzo di prodotti acidi o alcalini, ceranti, pagliette di metallo o abrasive. - Nous vous conseillons d'utiliser des détergents neutres courants. Éviter l'utilisation de cires et de produits acides ou alcalins, ainsi que les pailles métalliques ou abrasives. - Es empfiehlt sich, ein haushaltsübliches, neutrales Reinigungsmittel zu verwenden. Saure oder alkalische Produkte, Wachs sowie Metallwolle- bzw. Scheuerschwämme sind zu vermeiden. - Recomendamos utilizar un detergente neutro común. Hay que evitar el uso de productos ácidos o alcalinos, ceras y estropajos de metal o abrasivos. - Рекомендуется чистить обычным нейтральным моющим средством. Не рекомендуется использовать кислотные, щелочные, восковые средства, а также металлические мочалки.

**The decoration can only be laid on the wall** - Il decoro si può posare solo a rivestimento - Décor uniquement mural - Das Dekor kann nur an der Wand verlegt werden  
La decoración se puede colocar únicamente en paredes - Декор может быть уложен только на стену.

TRIM TILES p. 352	Battiscopa		Gradino *		Scalino *		Scalino *		Scalino Ang.*		Battiscopa Sag. Scala *				Elemento L *		Corner *		Corner A.E *	
	7,2x60 cm 2 7/8" x 23 3/8"	30x60 cm 11 1/4" x 23 3/8"	33x120 cm 13" x 47 1/4"	33x60 cm 13" x 23 3/8"	33x33 cm 13" x 13"	7,2x30 cm 2 7/8" x 11 1/4"		33x120 H.4 cm 13" x 47 1/4" H.1 1/2"		1x120 cm 3/8" x 47 1/4"		1x1 cm 3/8" x 2 1/8"		± 6 mm		± 6 mm				
	Matte	Silk	Matte	Silk	Matte	Silk	Matte	Silk	Matte	Silk	Matte		Grip		Matte		Matte			
Cotton	A4XØ	A5SH	A4YI	A5SX	A4YU	A4Y6	A4YO	A5S3	A4YØ	A4ZD	SX	DX	SX	DX	-	A4ZJ	A4ZP			
Cord	A4XZ	A5SE	A4YH	A5SW	A4YT	A4Y5	A4YN	A5S2	A4YZ	A4ZC	A4YC	A4X6	A5SR	A5SL	A5OZ	A4ZI	A4ZO			
Suede	A4XY	A5SD	A4YG	A5SV	A4YS	A4Y4	A4YM	A5S1	A4YY	A4ZB	A4YA	A4X4	A5SP	A5SJ	A5OY	A4ZH	A4ZN			
Cloud	A4X1	A5SF	A4YJ	A5SY	A4YV	A4Y7	A4YP	A5S4	A4Y1	A4ZE	A4YD	A4X7	A5SS	A5SM	A5OØ	A4ZK	A4ZQ			
Fog	A4X2	A5SG	A4YK	A5SZ	A4YW	A4Y9	A4YQ	A5S5	A4Y2	A4ZF	A4YE	A4X8	A5ST	A5SN	A5O1	A4ZL	A4ZR			
Graphite	A4X3	A5SI	A4YL	A5SØ	A4YX	A4ZA	A4YR	A5S6	A4Y3	A4ZG	A4YF	A4X9	A5SU	A5SO	-	A4ZM	A4ZS			

\* These parts are supplied to order - I pezzi sono disponibili su ordinazione - Les pièces sont disponibles sur commande - Die Teile sind auf Bestellung lieferbar - Las piezas se hacen por encargo - Изготавливаются на заказ

- INDEX
- A COMPLETE PRODUCT SYSTEM
- PRODUCT FINDER
- SURFACE RANGE
- COMPANY
- COLLECTIONS
  - 3D WALL
  - CONCRETE & RESIN LOOK
  - METAL LOOK
  - MARBLE LOOK
  - STONE LOOK
  - WOOD LOOK
- LARGE SIZES
- SLABS FOR COUNTERTOPS & FURNITURE
- SINKS & BATHROOM FURNISHING
- FACADES
- TECHNICAL SPECIFICATIONS

# Prism Wall Tiles

## MATTE SURFACE



± 8,5 mm

50x120 cm - 19<sup>5</sup>/<sub>8</sub>"x47<sup>1</sup>/<sub>4</sub>"

- A4TF Prism Suede
- A4TG Prism Cord
- A4TH Prism Cotton
- A4TI Prism Cloud
- A4TJ Prism Graphite
- A4TK Prism Bloom
- A4TL Prism Caramel
- A4TM Prism Grape
- A4TN Prism Dusk
- A4TO Prism Midnight
- A4TP Prism Moss
- A4TQ Prism Emerald

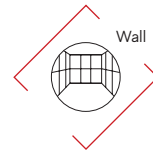

## TRIM TILES

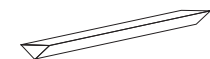

1,4x50 cm - 5<sup>1</sup>/<sub>8</sub>"x19<sup>5</sup>/<sub>8</sub>"

- A4ØO Prism Suede Corner 50 \*
- A4ØP Prism Cord Corner 50 \*
- A4ØQ Prism Cotton Corner 50 \*
- A4ØR Prism Cloud Corner 50 \*
- A4ØS Prism Graphite Corner 50 \*
- A4ØT Prism Bloom Corner 50 \*
- A4ØU Prism Caramel Corner 50 \*
- A4ØV Prism Grape Corner 50 \*
- A4ØW Prism Dusk Corner 50 \*
- A4ØX Prism Midnight Corner 50 \*
- A4ØY Prism Moss Corner 50 \*
- A4ØZ Prism Emerald Corner 50 \*



1,4x1,4 cm - 5<sup>1</sup>/<sub>8</sub>"x5<sup>1</sup>/<sub>8</sub>"

- A4Ø1 Prism Suede Corner A.E. \*
- A4Ø2 Prism Cord Corner A.E. \*
- A4Ø3 Prism Cotton Corner A.E. \*
- A4Ø4 Prism Cloud Corner A.E. \*
- A4Ø5 Prism Graphite Corner A.E. \*
- A4Ø6 Prism Bloom Corner A.E. \*
- A4Ø7 Prism Caramel Corner A.E. \*
- A4Ø8 Prism Grape Corner A.E. \*
- A4Ø9 Prism Dusk Corner A.E. \*
- A41A Prism Midnight Corner A.E. \*
- A41B Prism Moss Corner A.E. \*
- A41C Prism Emerald Corner A.E. \*

\* These parts are supplied to order - I pezzi sono disponibili su ordinazione - Les pièces sont disponibles sur commande - Die Teile sind auf Bestellung lieferbar - Las piezas se hacen por encargo - Изготавливаются на заказ

## DECOR RANGE



<sup>(1)</sup> Application of decorative materials. The use of a common mild detergent is recommended. Avoid using acidic or alkaline products, waxes, steel wool, or abrasives. - Applicazione di materia decorative. Si consiglia l'utilizzo di un comune detergente neutro. Evitare l'utilizzo di prodotti acidi o alcalini, ceranti e pagliette di metallo o abrasive. - Application de matériaux décoratifs. Nous conseillons l'emploi de détergents neutres courants. Éviter l'utilisation de cires et de produits acides ou alcalins, ainsi que les pailles métalliques ou abrasives. - Dekorationsmaterial. Es empfiehlt sich, ein haushaltsübliches, neutrales Reinigungsmittel zu verwenden. Saure oder alkalische Produkte, Wachs sowie Stahlwolle- bzw. Scheuerschwämme sind zu vermeiden. Aplicación de materiales decorativos. Recomendamos utilizar un detergente neutro común. Hay que evitar el uso de productos ácidos o alcalinos, ceras y estropajos de metal o abrasivos. - Применение декоративных материалов. Рекомендуется чистить обычным нейтральным моющим средством. Не рекомендуется использовать кислотные, щелочные, восковые средства, а также металлические мочалки.

INDEX



A COMPLETE  
PRODUCT  
SYSTEM



PRODUCT  
FINDER



SURFACE  
RANGE



COMPANY



COLLECTIONS



3D WALL  
CONCRETE & RESIN LOOK  
METAL LOOK  
MARBLE LOOK  
STONE LOOK  
WOOD LOOK

LARGE SIZES



SLABS FOR  
COUNTERTOPS  
& FURNITURE



SINKS &  
BATHROOM  
FURNISHING



FACADES



TECHNICAL  
SPECIFICATIONS





# Prism

## Wall Tiles

### DECOR RANGE



A4TS Prism Brush <sup>(1)</sup>  
50x120 cm - 19<sup>3</sup>/<sub>8</sub>"x47<sup>1</sup>/<sub>4</sub>"

8 patterns



A4ZT Prism Enigma  
50x120 cm - 19<sup>3</sup>/<sub>8</sub>"x47<sup>1</sup>/<sub>4</sub>"

This item matches with the following colors / Questo articolo si abbina ai colori seguenti:  
Cloud 50x120, Graphite 50x120, Cotton 50x120



A4TR Prism Gradient <sup>(2)</sup>  
50x120 cm - 19<sup>3</sup>/<sub>8</sub>"x47<sup>1</sup>/<sub>4</sub>"

12 patterns



A4ZU Prism GoldM <sup>(1)</sup>  
50x120 cm - 19<sup>3</sup>/<sub>8</sub>"x47<sup>1</sup>/<sub>4</sub>"

This item matches with the following colors / Questo articolo si abbina ai colori seguenti:  
Bloom 50x120, Caramel 50x120, Grape 50x120, Cord 50x120, Cloud 50x120, Suede 50x120, Cotton 50x120

<sup>(1)</sup> Contains gold. The use of a common mild detergent is recommended. Avoid using acidic or alkaline products, waxes, steel wool, or abrasives. - Parti in oro. Si consiglia l'utilizzo di un comune detergente neutro. Evitare l'utilizzo di prodotti acidi o alcalini, ceranti, pagliette di metallo o abrasive. - Parties dorées. Nous vous conseillons d'utiliser des détergents neutres courants. Éviter l'utilisation de cires et de produits acides ou alcalins, ainsi que les pailles métalliques ou abrasives. - Teile aus Gold. Es empfiehlt sich, ein haushaltsübliches, neutrales Reinigungsmittel zu verwenden. Saure oder alkalische Produkte, Wachs sowie Metallwolle- bzw. Scheuerschwämme sind zu vermeiden. - Partes doradas. Recomendamos utilizar un detergente neutro común. Hay que evitar el uso de productos ácidos o alcalinos, ceras y estropajos de metal o abrasivos. - Золотые детали. Рекомендуется чистить обычным нейтральным моющим средством. Не рекомендуется использовать кислотные, щелочные, восковые средства, а также металлические мочалки.

<sup>(2)</sup> Item sold by square meter. - Articolo venduto al mq. - Article vendu au mètre carré. - Artikel pro m<sup>2</sup> verkauft. - Artículo vendido por m<sup>2</sup>. - Артикул продается квадратными метрами.



© Ceramiche Atlas Concorde



© Ceramiche Atlas Concorde



© Ceramiche Atlas Concorde

INDEX



A COMPLETE PRODUCT SYSTEM >

PRODUCT FINDER >

SURFACE RANGE >

COMPANY >

COLLECTIONS >

3D WALL  
CONCRETE & RESIN LOOK  
METAL LOOK  
MARBLE LOOK  
STONE LOOK  
WOOD LOOK

LARGE SIZES >

SLABS FOR COUNTERTOPS & FURNITURE >

SINKS & BATHROOM FURNISHING >

FACADES >

TECHNICAL SPECIFICATIONS >

# Venti Boost



© Ceramiche Atlas Concorde



© Ceramiche Atlas Concorde



© Ceramiche Atlas Concorde

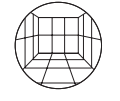
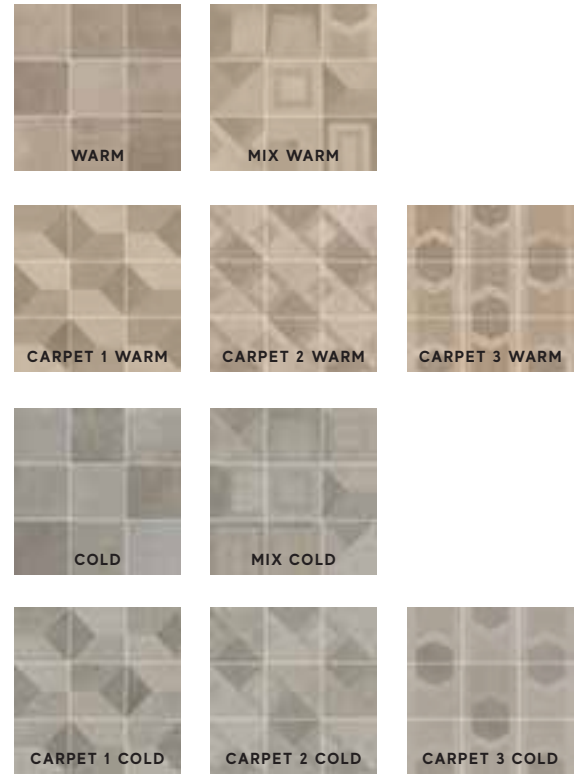



Floor & Wall

**Porcelain Tiles** PORCELAIN TILES - NON-RECTIFIED  
**Sizes** 20x20 cm - 7 7/8"x7 7/8"  
**Thickness** ± 9 mm  
**Surface finish** Matte R10 A





**Glazed Porcelain Tiles** RECTIFIED MONOCALIBER  
**Sizes** 20x20 cm - 7 7/8"x7 7/8"  
**Thickness** ± 9 mm  
**Surface finish** Matte R9 A

INDEX 

A COMPLETE PRODUCT SYSTEM 

PRODUCT FINDER 

SURFACE RANGE 

COMPANY 

COLLECTIONS 

- 3D WALL
- CONCRETE & RESIN LOOK
- METAL LOOK
- MARBLE LOOK
- STONE LOOK
- WOOD LOOK

LARGE SIZES 

SLABS FOR COUNTERTOPS & FURNITURE 

SINKS & BATHROOM FURNISHING 

FACADES 

TECHNICAL SPECIFICATIONS 

# Venti Boost

## Porcelain Tiles



Matte ± 9 mm



R10 A Matte ± 9 mm



V2 Slight Variation  
Carpet 1 Warm, Carpet 2 Warm, Carpet 3 Warm,  
Carpet 1 Cold, Carpet 2 Cold, Carpet 3 Cold

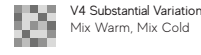

V4 Substantial Variation  
Mix Warm, Mix Cold



### MATTE SURFACE



A3OD Venti Boost Warm  
20x20 - 7 1/8"x7 1/8"



A3OF Venti Boost Mix Warm <sup>(1)</sup>  
20x20 - 7 1/8"x7 1/8"

16 Patterns



A3OJ Venti Boost Carpet 1W  
20x20 - 7 1/8"x7 1/8"



A3OK Venti Boost Carpet 2W  
20x20 - 7 1/8"x7 1/8"



A3OL Venti Boost Carpet 3W  
20x20 - 7 1/8"x7 1/8"

### MATTE SURFACE



A3OC Venti Boost Cold  
20x20 - 7 1/8"x7 1/8"



A3OE Venti Boost Mix Cold <sup>(1)</sup>  
20x20 - 7 1/8"x7 1/8"

16 Patterns



A3OG Venti Boost Carpet 1C  
20x20 - 7 1/8"x7 1/8"



A3OH Venti Boost Carpet 2C  
20x20 - 7 1/8"x7 1/8"

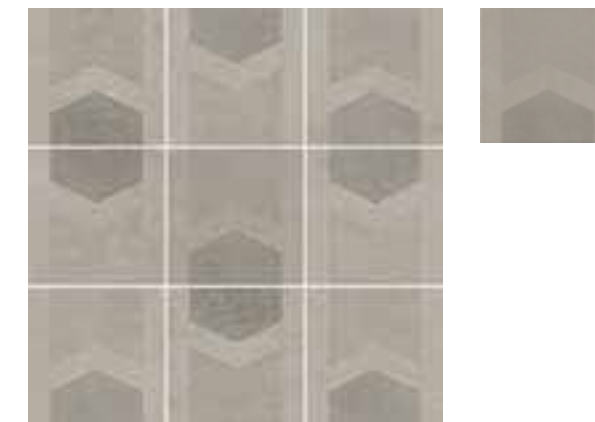

A3OI Venti Boost Carpet 3C  
20x20 - 7 1/8"x7 1/8"



<sup>(1)</sup> Article composed of 16 different graphics, randomly mixed inside the boxes. - Articolo composto da 16 grafiche diverse, miscelate in modo casuale all'interno delle scatole. - Article composé de 16 graphismes différents, mélangés au hasard dans les boîtes. - Artikel mit 16 verschiedenen Grafiken, in den Schachteln nach dem Zufallsprinzip gemischt. - Artículo compuesto por 16 gráficos diferentes, mezclados en manera casual dentro a las cajas. - Артикул состоит из 16 различных рисунков, случайно перемешанных внутри коробок.

INDEX



A COMPLETE  
PRODUCT  
SYSTEM >

PRODUCT  
FINDER >

SURFACE  
RANGE >

COMPANY >

COLLECTIONS >

3D WALL  
CONCRETE & RESIN LOOK  
METAL LOOK  
MARBLE LOOK  
STONE LOOK  
WOOD LOOK

LARGE SIZES >

SLABS FOR  
COUNTERTOPS  
& FURNITURE >

SINKS &  
BATHROOM  
FURNISHING >

FACADES >

TECHNICAL  
SPECIFICATIONS >

# Venti Boost

## Glazed Porcelain Tiles



Matte ± 9 mm



R9 A Matte ± 9 mm



V2 Slight Variation  
Classic Carpet 1, Classic Carpet 2, Classic Carpet 3,  
Blue Carpet 1, Blue Carpet 2, Blue Carpet 3



V4 Substantial Variation  
Classic Mix, Blue Mix



### MATTE SURFACE



A3OM Venti Boost Classic Mix <sup>(1)</sup>  
20x20 - 7<sup>1</sup>/<sub>8</sub>"x7<sup>1</sup>/<sub>8</sub>" 20 Patterns

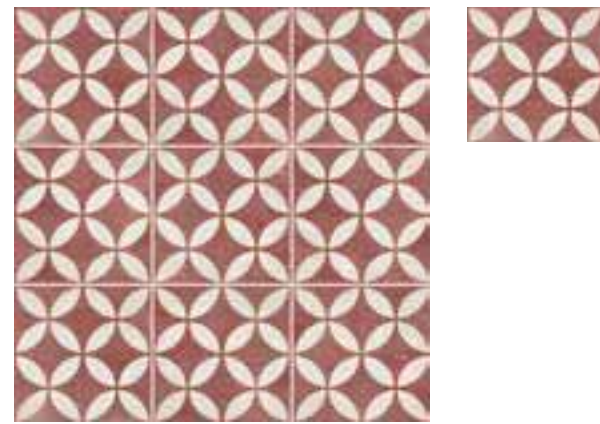

A3ON Venti Boost Classic Carpet 1  
20x20 - 7<sup>1</sup>/<sub>8</sub>"x7<sup>1</sup>/<sub>8</sub>"



A3OO Venti Boost Classic Carpet 2  
20x20 - 7<sup>1</sup>/<sub>8</sub>"x7<sup>1</sup>/<sub>8</sub>"

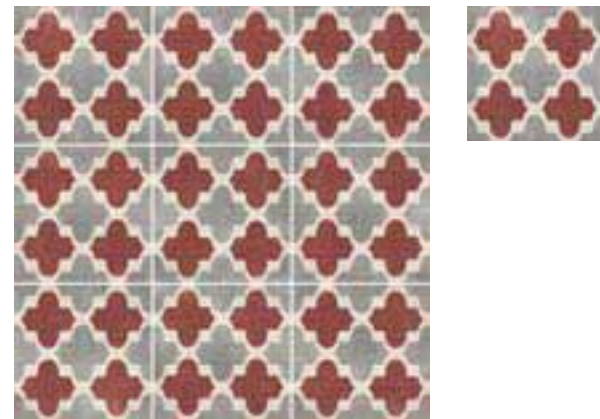

A3OP Venti Boost Classic Carpet 3  
20x20 - 7<sup>1</sup>/<sub>8</sub>"x7<sup>1</sup>/<sub>8</sub>"

### MATTE SURFACE



A3OQ Venti Boost Blue Mix <sup>(1)</sup>  
20x20 - 7<sup>1</sup>/<sub>8</sub>"x7<sup>1</sup>/<sub>8</sub>" 20 Patterns

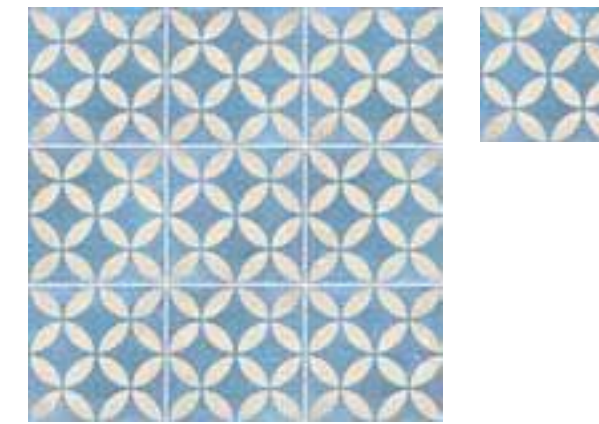

A3OR Venti Boost Blue Carpet 1  
20x20 - 7<sup>1</sup>/<sub>8</sub>"x7<sup>1</sup>/<sub>8</sub>"



A3OS Venti Boost Blue Carpet 2  
20x20 - 7<sup>1</sup>/<sub>8</sub>"x7<sup>1</sup>/<sub>8</sub>"



A3OT Venti Boost Blue Carpet 3  
20x20 - 7<sup>1</sup>/<sub>8</sub>"x7<sup>1</sup>/<sub>8</sub>"



<sup>(1)</sup> Article composed of 20 different graphics, randomly mixed inside the boxes. - Articolo composto da 20 grafiche diverse, miscelate in modo casuale all'interno delle scatole. - Article composé de 20 graphismes différents, mélangés au hasard dans les boîtes. - Artikel mit 20 verschiedenen Grafiken, in den Schachteln nach dem Zufallsprinzip gemischt. - Artículo compuesto por 20 gráficos diferentes, mezclados en manera casual dentro a las cajas. - Артикул состоит из 20 различных рисунков, случайно перемешанных внутри коробок.

INDEX



A COMPLETE  
PRODUCT  
SYSTEM >

PRODUCT  
FINDER >

SURFACE  
RANGE >

COMPANY >

COLLECTIONS >

3D WALL  
CONCRETE & RESIN LOOK  
METAL LOOK  
MARBLE LOOK  
STONE LOOK  
WOOD LOOK

LARGE SIZES >

SLABS FOR  
COUNTERTOPS  
& FURNITURE >

SINKS &  
BATHROOM  
FURNISHING >

FACADES >

TECHNICAL  
SPECIFICATIONS >

# Blaze



© Ceramiche Atlas Concorde



© Ceramiche Atlas Concorde



© Ceramiche Atlas Concorde

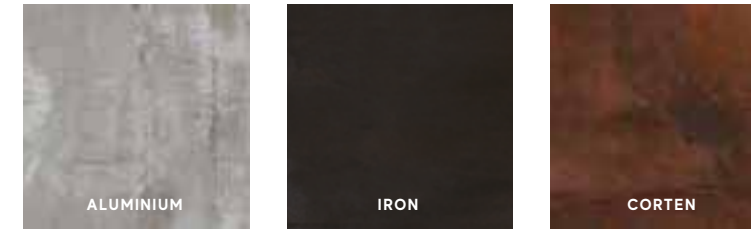
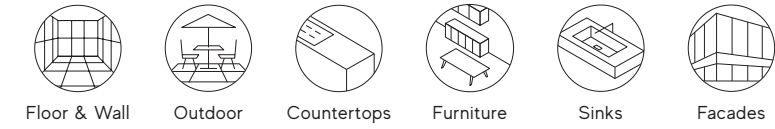

## Porcelain Tiles RECTIFIED MONOCALIBER

Sizes	Thickness	Surface finish
120x278 cm - 47 <sup>1</sup> / <sub>4</sub> "x109 <sup>1</sup> / <sub>2</sub> "	± 6 mm	Matte R9 A
120x120 cm - 47 <sup>1</sup> / <sub>4</sub> "x47 <sup>1</sup> / <sub>4</sub> "	± 9 mm	Matte R10 B
75x150 cm - 29 <sup>1</sup> / <sub>2</sub> "x59"	± 9 mm	Matte R10 B
75x75 cm - 29 <sup>1</sup> / <sub>2</sub> "x29 <sup>1</sup> / <sub>2</sub> "	± 9 mm	Matte R10 B

LARGE SIZES P. 356

### OUTDOOR AND WET AREAS

120x120 cm - 47 <sup>1</sup> / <sub>4</sub> "x47 <sup>1</sup> / <sub>4</sub> "	± 20 mm	Outdoor R11 C
60x60 cm - 23 <sup>3</sup> / <sub>8</sub> "x23 <sup>3</sup> / <sub>8</sub> "	± 20 mm	Outdoor R11 C

atlasPLAN

### SLABS FOR COUNTERTOPS & FURNITURE

162x324 cm - 63 <sup>3</sup> / <sub>4</sub> "x127 <sup>1</sup> / <sub>2</sub> " NON-RECTIFIED	± 12 mm	Matte
--	---------	-------

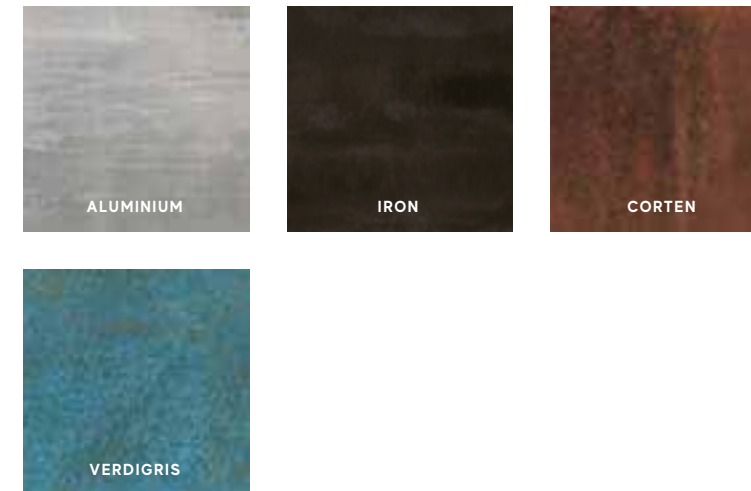

## Wall Tiles RECTIFIED MONOCALIBER

Sizes	Thickness	Surface finish
50x120 cm - 19 <sup>3</sup> / <sub>8</sub> "x47 <sup>1</sup> / <sub>4</sub> "	± 8,5 mm	Matte

INDEX



A COMPLETE PRODUCT SYSTEM >

PRODUCT FINDER >

SURFACE RANGE >

COMPANY >

COLLECTIONS >

3D WALL  
CONCRETE & RESIN LOOK  
METAL LOOK  
MARBLE LOOK  
STONE LOOK  
WOOD LOOK

LARGE SIZES >

SLABS FOR COUNTERTOPS & FURNITURE >

SINKS & BATHROOM FURNISHING >

FACADES >

TECHNICAL SPECIFICATIONS >

# Blaze

## Porcelain Tiles

### MATTE SURFACE



± 6 mm  
**120x278 cm** - 47<sup>1</sup>/<sub>4</sub>"x109<sup>1</sup>/<sub>2</sub>"  
 APO7 Blaze Aluminium  
 APO8 Blaze Corten  
 APO9 Blaze Iron



± 9 mm  
**120x120 cm** - 47<sup>1</sup>/<sub>4</sub>"x47<sup>1</sup>/<sub>4</sub>"  
 APPK Blaze Aluminium  
 APPW Blaze Corten  
 APPX Blaze Iron



± 9 mm  
**75x150 cm** - 29<sup>1</sup>/<sub>2</sub>"x59"  
 A7GS Blaze Aluminium  
 A7GT Blaze Corten  
 A7GU Blaze Iron



± 9 mm  
**75x75 cm** - 29<sup>1</sup>/<sub>2</sub>"x29<sup>1</sup>/<sub>2</sub>"  
 APOU Blaze Aluminium  
 APOV Blaze Corten  
 APOW Blaze Iron

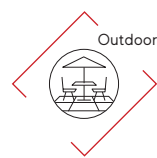

Matte ± 6 mm



Matte ± 9 mm  
 Outdoor ± 20 mm



R9 A Matte ± 6 mm  
 R10 B Matte ± 9 mm  
 R11 C Outdoor ± 20 mm



V3 Moderate Variation



ALUMINIUM



IRON

### OUTDOOR ± 20 mm



± 20 mm  
**120x120 cm** - 47<sup>1</sup>/<sub>4</sub>"x47<sup>1</sup>/<sub>4</sub>"  
 AØ5F Blaze Corten 20 mm



± 20 mm  
**60x60 cm** - 23<sup>5</sup>/<sub>8</sub>"x23<sup>5</sup>/<sub>8</sub>"  
 AØ5G Blaze Corten 20 mm

### TRIM TILES p. 352

	Battiscopa		Scalino *		Scalino Ang. *	Battiscopa Sag. Scala *	Elemento L *	Corner * ± 6 mm	Corner A.E * ± 6 mm
	7,2x150 cm 2 <sup>7</sup> / <sub>8</sub> "x59"	7,2x75 cm 2 <sup>7</sup> / <sub>8</sub> "x29 <sup>1</sup> / <sub>2</sub> "	37,5x150 cm 14 <sup>3</sup> / <sub>4</sub> "x59"	37,5x75 cm 15"x29 <sup>1</sup> / <sub>2</sub> "	37,5x37,5 cm 14 <sup>3</sup> / <sub>4</sub> "x14 <sup>3</sup> / <sub>4</sub> "	7,2x30 cm 2 <sup>7</sup> / <sub>8</sub> "x11 <sup>1</sup> / <sub>4</sub> "	15x75 H. 4 cm 5 <sup>7</sup> / <sub>8</sub> "x29 <sup>1</sup> / <sub>2</sub> " H. 1 <sup>1</sup> / <sub>8</sub> "	1x120 cm 3 <sup>1</sup> / <sub>8</sub> "x47 <sup>1</sup> / <sub>4</sub> "	1x1 cm 3 <sup>1</sup> / <sub>8</sub> "x3 <sup>1</sup> / <sub>8</sub> "
	Matte	Matte	Matte	Matte	Matte	Matte	Grip	Matte	Matte
Aluminium	AØIN	AØIH	AØI8	AØI2	AØJE	DX AØIT	AØJK	AØUI	A19Y
Corten	AØIO	AØII	AØI9	AØI3	AØJF	SX AØIU	AØJL	AØUJ	A19Z
Iron	AØIP	AØIJ	AØJA	AØI4	AØJG	AØIV AØIY	AØJM	AØUK	A19Ø

\* These parts are supplied to order - I pezzi sono disponibili su ordinazione - Les pièces sont disponibles sur commande - Die Teile sind auf Bestellung lieferbar - Las piezas se hacen por encargo - Изготавливаются на заказ

### COMPLETE YOUR PROJECT

Countertops  
P.402  
162x324 cm  
NON-RECTIFIED

Furniture  
P.356

Sinks  
P.412

Facades  
P.436

INDEX



A COMPLETE PRODUCT SYSTEM >

PRODUCT FINDER >

SURFACE RANGE >

COMPANY >

COLLECTIONS >

3D WALL  
 CONCRETE & RESIN LOOK  
 METAL LOOK  
 MARBLE LOOK  
 STONE LOOK  
 WOOD LOOK

LARGE SIZES >

SLABS FOR COUNTERTOPS & FURNITURE >

SINKS & BATHROOM FURNISHING >

FACADES >

TECHNICAL SPECIFICATIONS >

# Blaze

## Porcelain Tiles

### DECOR RANGE



AØUR Blaze Aluminium  
Mosaico 3D Factory <sup>(1)</sup>  
29x29 - 1<sup>1</sup>/<sub>8</sub>"x1<sup>1</sup>/<sub>8</sub>"

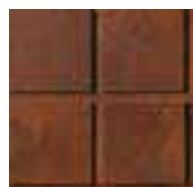

AØUS Blaze Corten  
Mosaico 3D Factory <sup>(1)</sup>  
29x29 - 1<sup>1</sup>/<sub>8</sub>"x1<sup>1</sup>/<sub>8</sub>"

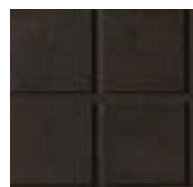

AØUT Blaze Iron  
Mosaico 3D Factory <sup>(1)</sup>  
29x29 - 1<sup>1</sup>/<sub>8</sub>"x1<sup>1</sup>/<sub>8</sub>"

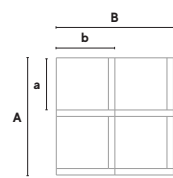

**A** 29 cm - 1<sup>1</sup>/<sub>8</sub>"  
**a** 12,9 cm - 5<sup>1</sup>/<sub>8</sub>"  
**B** 29 cm - 1<sup>1</sup>/<sub>8</sub>"  
**b** 14,5 cm - 5<sup>7</sup>/<sub>16</sub>"

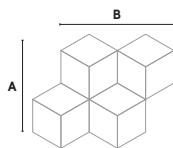

**A** 30,5 cm - 12"  
**B** 35,2 cm - 13<sup>7</sup>/<sub>16</sub>"

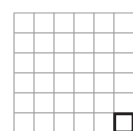

4,8x4,8 cm  
1<sup>7</sup>/<sub>16</sub>"x1<sup>7</sup>/<sub>16</sub>"



AØUO Blaze Aluminium  
Mosaico Esagono Matte  
35,2x30,5 - 13<sup>7</sup>/<sub>16</sub>"x12"



AØUP Blaze Corten  
Mosaico Esagono Matte  
35,2x30,5 - 13<sup>7</sup>/<sub>16</sub>"x12"



AØUQ Blaze Iron  
Mosaico Esagono Matte  
35,2x30,5 - 13<sup>7</sup>/<sub>16</sub>"x12"



AØUX Blaze Aluminium  
Mosaico Matte  
30x30 - 1<sup>1</sup>/<sub>4</sub>"x1<sup>1</sup>/<sub>4</sub>"



AØUY Blaze Corten  
Mosaico Matte  
30x30 - 1<sup>1</sup>/<sub>4</sub>"x1<sup>1</sup>/<sub>4</sub>"

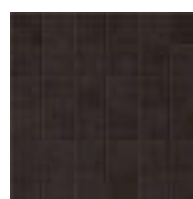

AØUZ Blaze Iron  
Mosaico Matte  
30x30 - 1<sup>1</sup>/<sub>4</sub>"x1<sup>1</sup>/<sub>4</sub>"

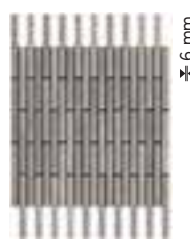

AØUU Blaze Aluminium  
Mosaico Twin <sup>(2)</sup>  
36,1x29,4 - 14<sup>1</sup>/<sub>4</sub>"x11<sup>5</sup>/<sub>8</sub>"



AØUV Blaze Corten  
Mosaico Twin <sup>(2)</sup>  
36,1x29,4 - 14<sup>1</sup>/<sub>4</sub>"x11<sup>5</sup>/<sub>8</sub>"

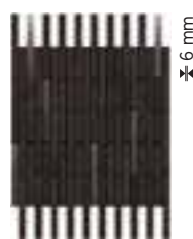

AØUW Blaze Iron  
Mosaico Twin <sup>(2)</sup>  
36,1x29,4 - 14<sup>1</sup>/<sub>4</sub>"x11<sup>5</sup>/<sub>8</sub>"

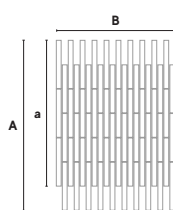

**A** 42,1 cm - 16<sup>5</sup>/<sub>8</sub>"  
**a** 36 cm - 14<sup>1</sup>/<sub>8</sub>"  
**B** 29,4 cm - 11<sup>5</sup>/<sub>8</sub>"

<sup>(1)</sup> Multi-thickness mosaic, close joint installation without grouting. - Mosaico multispessore, posa senza stuccatura a giunto nullo. - Mosaïque multi-épaisseur, pose sans mastic avec joint nul. - Mosaik mit verschiedenen Stärken, fugenlose Verlegung ohne Mörtel. Mosaico multispesor, colocación sin mástique y sin juntas. - Мозаика разной толщины, укладка встык без затирки швов.

<sup>(2)</sup> Application of decorative materials. The use of a common mild detergent is recommended. Avoid using acidic or alkaline products, waxes, steel wool, or abrasives. - Applicazione di materie decorative. Si consiglia l'utilizzo di un comune detergente neutro. Evitare l'utilizzo di prodotti acidi o alcalini, ceranti e pagliette di metallo o abrasive. - Application de matériaux décoratifs. Nous conseillons l'emploi de détergents neutres courants. Éviter l'utilisation de cires et de produits acides ou alcalins, ainsi que les pâilles métalliques ou abrasives. - Dekorationsmaterial. Es empfiehlt sich, ein haushaltsübliches, neutrales Reinigungsmittel zu verwenden. Saure oder alkalische Produkte, Wachs sowie Stahlwolle- bzw. Scheuerschwämme sind zu vermeiden. Aplicación de materiales decorativos. Recomendamos utilizar un detergente neutro común. Hay que evitar el uso de productos ácidos o alcalinos, ceras y estropajos de metal o abrasivos. - Применение декоративных материалов. Рекомендуется чистить обычным нейтральным моющим средством. Не рекомендуется использовать кислотные, щелочные, восковые средства, а также металлические мочалки.

The decoration can only be laid on the wall. - Il decoro si può posare solo a rivestimento murale. - Décor uniquement mural. - Das Dekor kann nur an der Wand verlegt werden. La decoración se puede colocar únicamente en paredes. - Декор может быть уложен только на стену.



© Ceramiche Atlas Concorde



© Ceramiche Atlas Concorde



© Ceramiche Atlas Concorde

INDEX



A COMPLETE  
PRODUCT  
SYSTEM



PRODUCT  
FINDER



SURFACE  
RANGE



COMPANY



COLLECTIONS



3D WALL  
CONCRETE & RESIN LOOK  
METAL LOOK  
MARBLE LOOK  
STONE LOOK  
WOOD LOOK

LARGE SIZES



SLABS FOR  
COUNTERTOPS  
& FURNITURE



SINKS &  
BATHROOM  
FURNISHING



FACADES



TECHNICAL  
SPECIFICATIONS



# Blaze

## Wall Tiles

### MATTE SURFACE



± 8,5 mm  
 50x120 cm - 19<sup>5</sup>/<sub>8</sub>"x47<sup>1</sup>/<sub>4</sub>"  
 A4R8 Blaze Aluminium  
 A4SB Blaze Iron  
 A4SA Blaze Corten  
 A4SC Blaze Verdigris

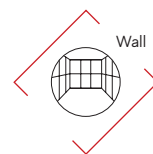

### TRIM TILES



1,4x50 cm - 5<sup>5</sup>/<sub>8</sub>"x19<sup>5</sup>/<sub>8</sub>"  
 LB5M Blaze Aluminium Corner 50 \*  
 LB5C Blaze Corten Corner 50 \*  
 LB5R Blaze Iron Corner 50 \*  
 LB5V Blaze Verdigris Corner 50 \*  
 LB5S Blaze Iron Stripes Corner 50 \*



1,4x1,4 cm - 5<sup>5</sup>/<sub>8</sub>"x5<sup>5</sup>/<sub>8</sub>"  
 AØLA Blaze Aluminium Corner A.E. 1,4 \*  
 AØLC Blaze Corten Corner A.E. 1,4 \*  
 AØLR Blaze Iron Corner A.E. 1,4 \*  
 AØLV Blaze Verdigris Corner A.E. 1,4 \*  
 AØLS Blaze Iron Stripes Corner A.E. 1,4 \*

\* These parts are supplied to order - I pezzi sono disponibili su ordinazione - Les pièces sont disponibles sur commande - Die Teile sind auf Bestellung lieferbar - Las piezas se hacen por encargo - Изготавливаются на заказ



### DECOR RANGE



A4UC Blaze Aluminium Texture <sup>(1)</sup>  
 50x120 cm - 19<sup>5</sup>/<sub>8</sub>"x47<sup>1</sup>/<sub>4</sub>"

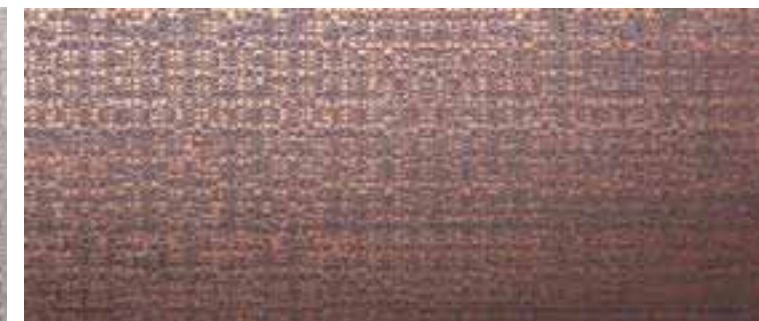

A4UD Blaze Corten Texture <sup>(1)</sup>  
 50x120 cm - 19<sup>5</sup>/<sub>8</sub>"x47<sup>1</sup>/<sub>4</sub>"

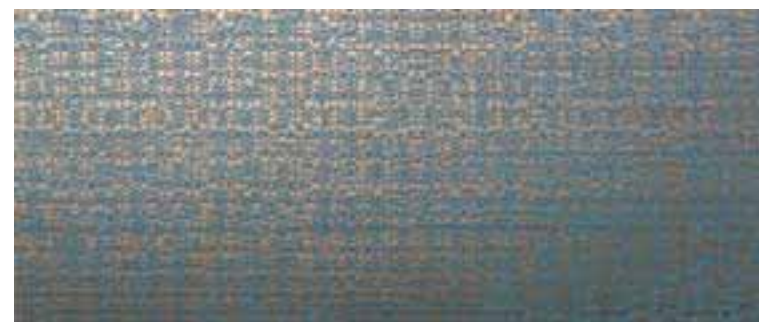

A4UE Blaze Verdigris Texture <sup>(1)</sup>  
 50x120 cm - 19<sup>5</sup>/<sub>8</sub>"x47<sup>1</sup>/<sub>4</sub>"



A4SD Blaze Iron Stripes <sup>(1)</sup>  
 50x120 cm - 19<sup>5</sup>/<sub>8</sub>"x47<sup>1</sup>/<sub>4</sub>"



9BNA Blaze Aluminium Mosaico Nest <sup>(1)</sup>  
 29,4x25,8 - 11<sup>5</sup>/<sub>8</sub>"x10<sup>1</sup>/<sub>8</sub>"



9BNC Blaze Corten Mosaico Nest <sup>(1)</sup>  
 29,4x25,8 - 11<sup>5</sup>/<sub>8</sub>"x10<sup>1</sup>/<sub>8</sub>"



9BNI Blaze Iron Mosaico Nest <sup>(1)</sup>  
 29,4x25,8 - 11<sup>5</sup>/<sub>8</sub>"x10<sup>1</sup>/<sub>8</sub>"



9BNV Blaze Verdigris Mosaico Nest <sup>(1)</sup>  
 29,4x25,8 - 11<sup>5</sup>/<sub>8</sub>"x10<sup>1</sup>/<sub>8</sub>"

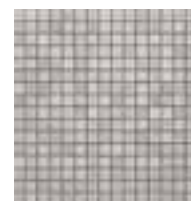
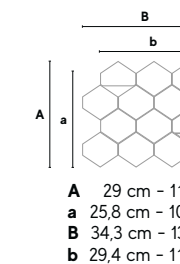

9BQA Blaze Aluminium Mos Q  
 30,5x30,5 - 12"x12"



9BQC Blaze Corten Mos Q  
 30,5x30,5 - 12"x12"

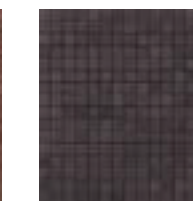

9BQI Blaze Iron Mos Q  
 30,5x30,5 - 12"x12"



9BQV Blaze Verdigris Mos Q  
 30,5x30,5 - 12"x12"

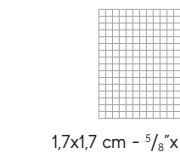

<sup>(1)</sup> Application of decorative materials. The use of a common mild detergent is recommended. Avoid using acidic or alkaline products, waxes, steel wool, or abrasives. - Applicazione di materie decorative. Si consiglia l'utilizzo di un comune detergente neutro. Evitare l'utilizzo di prodotti acidi o alcalini, ceranti e pagliette di metallo o abrasive. - Application de matériaux décoratifs. Nous conseillons l'emploi de détergents neutres courants. Éviter l'utilisation de cires et de produits acides ou alcalins, ainsi que les pâilles métalliques ou abrasives. - Dekorationsmaterial. Es empfiehlt sich, ein haushaltsübliches, neutrales Reinigungsmittel zu verwenden. Saure oder alkalische Produkte, Wachs sowie Stahlwolle- bzw. Scheuerschwämme sind zu vermeiden. - Aplicación de materiales decorativos. Recomendamos utilizar un detergente neutro común. Hay que evitar el uso de productos ácidos o alcalinos, ceras y estropajos de metal o abrasivos. - Применение декоративных материалов. Рекомендуется чистить обычным нейтральным моющим средством. Не рекомендуется использовать кислотные, щелочные, восковые средства, а также металлические мочалки.

INDEX



A COMPLETE PRODUCT SYSTEM



PRODUCT FINDER



SURFACE RANGE



COMPANY



COLLECTIONS



3D WALL  
 CONCRETE & RESIN LOOK  
 METAL LOOK  
 MARBLE LOOK  
 STONE LOOK  
 WOOD LOOK

LARGE SIZES



SLABS FOR COUNTERTOPS & FURNITURE



SINKS & BATHROOM FURNISHING



FACADES



TECHNICAL SPECIFICATIONS





# Marvel

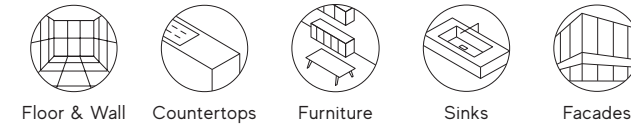

© Ceramiche Atlas Concorde



© Ceramiche Atlas Concorde



© Ceramiche Atlas Concorde

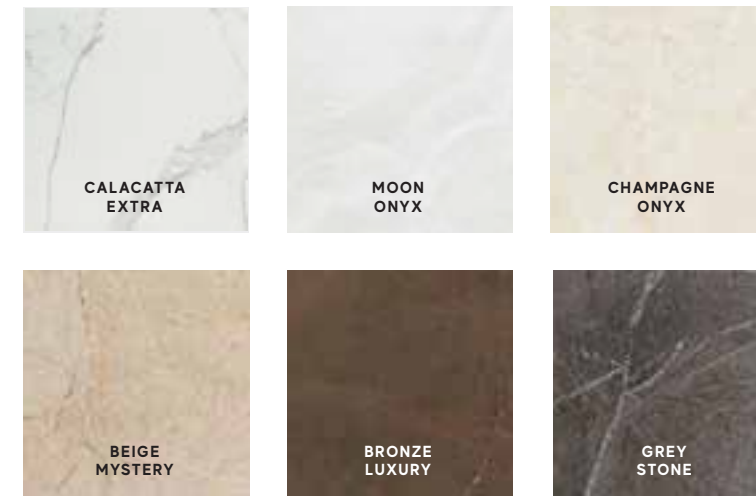

## Porcelain Tiles RECTIFIED MONOCALIBER

Sizes	Thickness	Surface finish
160x160 cm - 63"x63"	± 6 mm	Polished   Matte <b>R9 A</b>
120x278 cm - 47 <sup>1</sup> / <sub>4</sub> "x109 <sup>1</sup> / <sub>2</sub> "	± 6 mm	Polished   Matte <b>R9 A</b>
120x240 cm - 47 <sup>1</sup> / <sub>4</sub> "x94 <sup>1</sup> / <sub>2</sub> "	± 9 mm	Polished
120x120 cm - 47 <sup>1</sup> / <sub>4</sub> "x47 <sup>1</sup> / <sub>4</sub> "	± 9 mm	Polished   Matte <b>Sensitech R10 B</b>
60x120 cm - 23 <sup>5</sup> / <sub>8</sub> "x47 <sup>1</sup> / <sub>4</sub> "	± 9 mm	Polished   Matte <b>Sensitech R10 B</b>
75x150 cm - 29 <sup>1</sup> / <sub>2</sub> "x59"	± 9 mm	Polished   Matte <b>Sensitech R10 B</b>
75x75 cm - 29 <sup>1</sup> / <sub>2</sub> "x29 <sup>1</sup> / <sub>2</sub> "	± 9 mm	Polished   Matte <b>Sensitech R10 B</b>
60x60 cm - 23 <sup>5</sup> / <sub>8</sub> "x23 <sup>5</sup> / <sub>8</sub> "	± 9 mm	Polished   Matte <b>Sensitech R10 B</b>
30x60 cm - 11 <sup>3</sup> / <sub>4</sub> "x23 <sup>5</sup> / <sub>8</sub> "	± 9 mm	Polished   Matte <b>Sensitech R10 B</b>

LARGE SIZES p. 356

### atlasPLAN

Sizes	Thickness	Surface finish
160x320 cm - 63"x126"	± 6 mm	Polished   Matte <b>R9 A</b>

### SLABS FOR COUNTERTOPS & FURNITURE

Sizes	Thickness	Surface finish
162x324 cm - 63 <sup>3</sup> / <sub>4</sub> "x127 <sup>1</sup> / <sub>2</sub> " NON-RECTIFIED	± 6-12-20 mm	Polished   Silk   Matte
159x324 cm - 62 <sup>5</sup> / <sub>8</sub> "x127 <sup>1</sup> / <sub>2</sub> " NON-RECTIFIED	± 20 mm	Polished   Matte

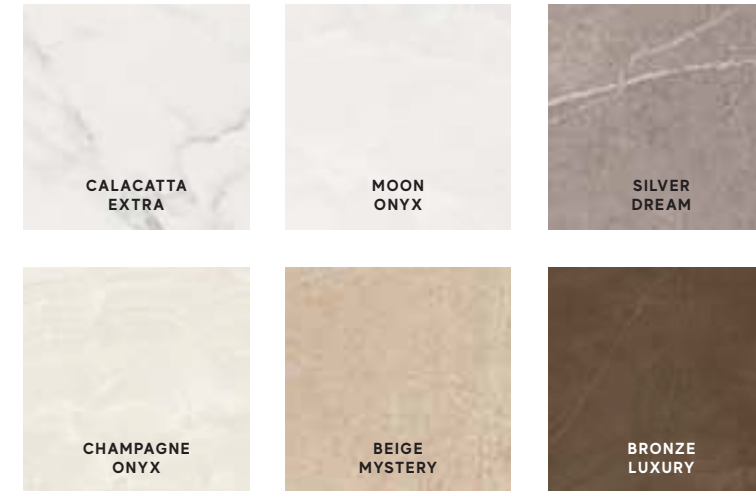

## Wall Tiles RECTIFIED MONOCALIBER

Sizes	Thickness	Surface finish
50x120 cm - 19 <sup>5</sup> / <sub>8</sub> "x47 <sup>1</sup> / <sub>4</sub> "	± 8,5 mm	Shiny
40x80 cm - 15 <sup>3</sup> / <sub>4</sub> "x31 <sup>1</sup> / <sub>2</sub> "	± 8,5 mm	Shiny
30,5x91,5 cm - 12"x36"	± 8,5 mm	Shiny
30,5x56 cm - 12"x22"	± 8,5 mm	Shiny
8x31,5 cm - 3 <sup>1</sup> / <sub>8</sub> "x12 <sup>3</sup> / <sub>8</sub> "	± 8,5 mm	Shiny

INDEX

A COMPLETE PRODUCT SYSTEM

PRODUCT FINDER

SURFACE RANGE

COMPANY

COLLECTIONS

3D WALL  
CONCRETE & RESIN LOOK  
METAL LOOK  
MARBLE LOOK  
STONE LOOK  
WOOD LOOK

LARGE SIZES

SLABS FOR COUNTERTOPS & FURNITURE

SINKS & BATHROOM FURNISHING

FACADES

TECHNICAL SPECIFICATIONS

# Marvel

## Porcelain Tiles

### POLISHED SURFACE <sup>(1)</sup>



± 6 mm  
160x320 cm - 63"x126"  
AO5U Marvel Calacatta Extra Polished



± 6 mm  
160x160 cm - 63"x63"  
AO51 Marvel Calacatta Extra Polished



± 6 mm  
120x278 cm - 47 1/4"x109 1/2"  
A08M Marvel Calacatta Extra Polished  
A0TJ Marvel Calacatta Extra Bookmatch A Polished  
A0TK Marvel Calacatta Extra Bookmatch B Polished  
AOQD Marvel Grey Stone Polished  
AOUB Marvel Calacatta Extra Endless Polished  
A6DU Marvel Calacatta Extra Kit Endless Lp Polished <sup>(2) (3)</sup>



± 9 mm  
120x240 cm - 47 1/4"x94 1/2"  
AY2N Marvel Calacatta Extra Polished  
AY2R Marvel Calacatta Extra Polished  
AY2O Marvel Grey Stone Polished



± 9 mm  
120x120 cm - 47 1/4"x47 1/4"  
AY2R Marvel Calacatta Extra Polished  
AY2S Marvel Grey Stone Polished



± 9 mm  
60x120 cm - 23 5/8"x47 1/4"  
A21S Marvel Calacatta Extra Polished  
A21H Marvel Grey Stone Polished



± 9 mm  
75x150 cm - 29 1/2"x59"  
A61F Marvel Calacatta Extra Polished  
A7FN Marvel Grey Stone Polished  
A7FM Marvel Champagne Onyx Polished



± 9 mm  
75x75 cm - 29 1/2"x29 1/2"  
ADPV Marvel Calacatta Extra Polished  
ADPX Marvel Moon Onyx Polished  
ADPY Marvel Grey Stone Polished  
ADPW Marvel Champagne Onyx Polished  
ADPT Marvel Beige Mystery Polished  
ADPU Marvel Bronze Luxury Polished



± 9 mm  
60x60 cm - 23 5/8"x23 5/8"  
7N3O Marvel Calacatta Extra Polished  
7N3P Marvel Moon Onyx Polished  
7N3T Marvel Grey Stone Polished  
7N3Q Marvel Champagne Onyx Polished  
7N3R Marvel Beige Mystery Polished  
7N3S Marvel Bronze Luxury Polished



± 9 mm  
30x60 cm - 11 3/4"x23 5/8"  
D016 Marvel Calacatta Extra Polished  
D017 Marvel Moon Onyx Polished  
D021 Marvel Grey Stone Polished  
D018 Marvel Champagne Onyx Polished  
D019 Marvel Beige Mystery Polished  
D020 Marvel Bronze Luxury Polished

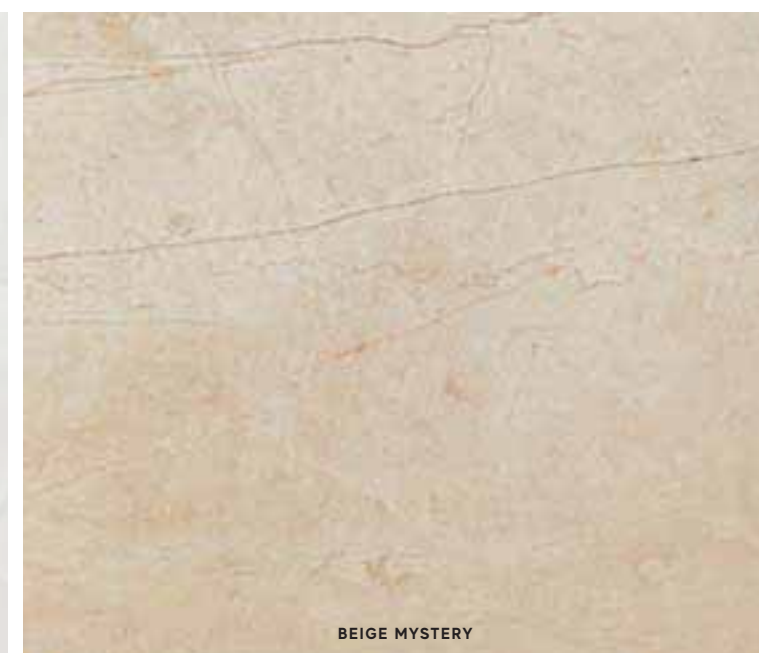

<sup>(1)</sup> The glossy polished finish is suitable for residential or low-traffic commercial floors, where no anti-slip performance is required, and for walls. The polished glossy surface finish, surprisingly brilliant and bright, features slight irregularities typical of natural marble. The extraordinary brilliance and the easy cleaning of the surface are the result of in-depth research aimed at guaranteeing its durability over time. If the product is in direct contact with the outdoors, provide devices for absorbing moisture and dirt to prevent scratches. - La finitura lappata lucida è indicata per pavimenti residenziali o commerciali poco sollecitati, laddove non siano richieste prestazioni antiscivolo, e per rivestimenti. La finitura lappata lucida offre una superficie sorprendentemente brillante e specchiante, con lievi irregolarità tipiche dei marmi naturali. La straordinaria lucentezza e l'elevata pulibilità della superficie sono frutto di studi approfonditi e accurate ricerche tecniche volte a garantirne la persistenza nel tempo. Se il prodotto è a diretto contatto con l'esterno, prevedere dei dispositivi di assorbimento dell'umidità e della sporcizia per prevenire la formazione di graffi.

<sup>(2)(3)</sup> Please read the notes at page 401

### COMPLETE YOUR PROJECT

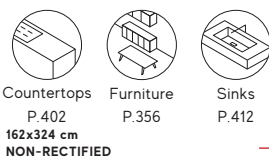

INDEX



A COMPLETE PRODUCT SYSTEM



PRODUCT FINDER



SURFACE RANGE



COMPANY



COLLECTIONS



3D WALL  
CONCRETE & RESIN LOOK  
METAL LOOK  
MARBLE LOOK  
STONE LOOK  
WOOD LOOK

LARGE SIZES



SLABS FOR COUNTERTOPS & FURNITURE



SINKS & BATHROOM FURNISHING



FACADES



TECHNICAL SPECIFICATIONS



# Marvel

## Porcelain Tiles

### MATTE SURFACE



± 6 mm  
160x320 cm - 63"x126"  
AO5Y Marvel Calacatta Extra



± 6 mm  
160x160 cm - 63"x63"  
AO54 Marvel Calacatta Extra

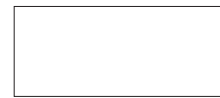

± 6 mm  
120x278 cm - 47 1/4"x109 1/2"  
A0BT Marvel Calacatta Extra  
A2RP Marvel Grey Stone



± 9 mm  
120x120 cm - 47 1/4"x47 1/4"  
A20Y Marvel Calacatta Extra  
AEQY Marvel Grey Stone



± 9 mm  
60x120 cm - 23 5/8"x47 1/4"  
A208 Marvel Calacatta Extra  
A209 Marvel Grey Stone



± 9 mm  
60x60 cm - 23 5/8"x23 5/8"  
7N3A Marvel Calacatta Extra  
7N3B Marvel Moon Onyx  
7N3F Marvel Grey Stone  
7N3C Marvel Champagne Onyx  
7N3D Marvel Beige Mystery  
7N3E Marvel Bronze Luxury



± 9 mm  
30x60 cm - 11 3/4"x23 5/8"  
D095 Marvel Calacatta Extra  
D096 Marvel Moon Onyx  
D100 Marvel Grey Stone  
D097 Marvel Champagne Onyx  
D098 Marvel Beige Mystery  
D099 Marvel Bronze Luxury



± 9 mm  
75x150 cm - 29 1/2"x59"  
A7HX Marvel Calacatta Extra



± 9 mm  
75x75 cm - 29 1/2"x29 1/2"  
ASCE Marvel Calacatta Extra  
ASCF Marvel Moon Onyx  
ASCJ Marvel Grey Stone  
ASCG Marvel Champagne Onyx  
ASCH Marvel Beige Mystery  
ASCI Marvel Bronze Luxury



Matte ± 6 mm



Matte Sensitech (S) ± 9 mm



R9 A Matte ± 6 mm  
R10 B Matte Sensitech (S) ± 9 mm



V2 Slight Variation



CALACATTA EXTRA



CHAMPAGNE ONYX



MOON ONYX

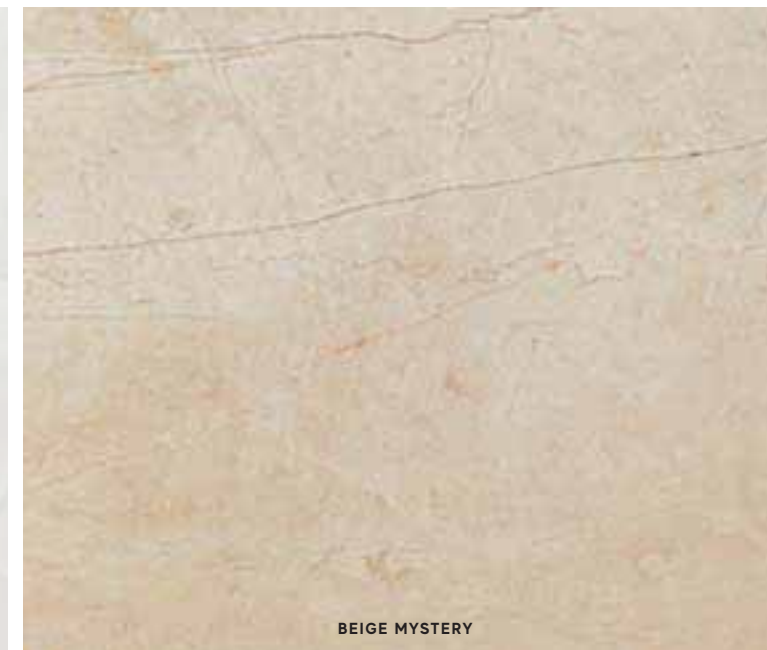

BEIGE MYSTERY



GREY STONE



BRONZE LUXURY

### TRIM TILES

p. 352

	Battiscopa		Gradino *		Scalino *		Scalino Ang.*		Battiscopa Sag. Scala *	
	Matte	Polished	Matte	Matte	Matte	Matte	Matte	Matte	DX	SX
Calacatta Extra	ASLJ	AVXS	ASLQ	ASMZ	ASMN	ASMT	ASNC	ASNI		
Moon Onyx	ASLK	AVXT	ASLR	ASM0	ASMO	ASMU	ASND	ASNJ		
Champagne Onyx	ASLL	AVXU	ASLS	ASM1	ASMP	ASMV	ASNE	ASNK		
Beige Mystery	ASLM	AVXV	ASLT	ASM2	ASMQ	ASMW	ASNF	ASNL		
Bronze Luxury	ASLN	AVXW	ASLU	ASM5	ASMR	ASMX	ASNG	ASNM		
Grey Stone	ASLO	AVXX	ASLV	ASM7	ASMS	ASMY	ASNH	ASNN		

\* These parts are supplied to order - I pezzi sono disponibili su ordinazione - Les pièces sont disponibles sur commande - Die Teile sind auf Bestellung lieferbar - Las piezas se hacen por encargo - Изготавливаются на заказ

### COMPLETE YOUR PROJECT

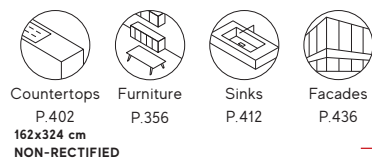

Countertops P.402  
162x324 cm  
NON-RECTIFIED

Furniture P.356

Sinks P.412

Facades P.436

A COMPLETE PRODUCT SYSTEM >

PRODUCT FINDER >

SURFACE RANGE >

COMPANY >

COLLECTIONS >

3D WALL  
CONCRETE & RESIN LOOK  
METAL LOOK  
MARBLE LOOK  
STONE LOOK  
WOOD LOOK

LARGE SIZES >

SLABS FOR COUNTERTOPS & FURNITURE >

SINKS & BATHROOM FURNISHING >

FACADES >

TECHNICAL SPECIFICATIONS >

# Marvel

## Porcelain Tiles

### DECOR RANGE



ASLC Marvel Calacatta Mosaico 3D<sup>(1)</sup> 30x30 - 1 1/4" x 1 1/4"  
 ASLD Marvel Moon Mosaico 3D<sup>(1)</sup> 30x30 - 1 1/4" x 1 1/4"  
 ASLH Marvel Grey Mosaico 3D<sup>(1)</sup> 30x30 - 1 1/4" x 1 1/4"  
 ASLE Marvel Champagne Mosaico 3D<sup>(1)</sup> 30x30 - 1 1/4" x 1 1/4"  
 ASLF Marvel Beige Mosaico 3D<sup>(1)</sup> 30x30 - 1 1/4" x 1 1/4"  
 ASLG Marvel Bronze Mosaico 3D<sup>(1)</sup> 30x30 - 1 1/4" x 1 1/4"

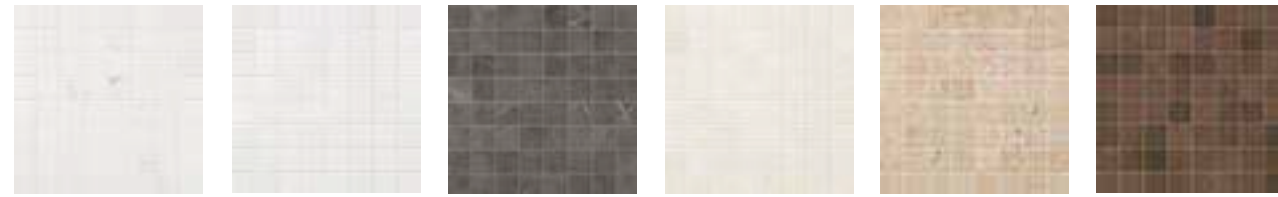
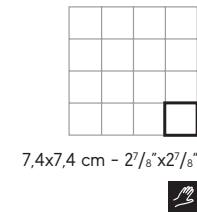

ASK5 Marvel Calacatta Mosaico Matte 30x30 - 1 1/4" x 1 1/4"  
 ASK6 Marvel Moon Mosaico Matte 30x30 - 1 1/4" x 1 1/4"  
 ASLA Marvel Grey Mosaico Matte 30x30 - 1 1/4" x 1 1/4"  
 ASK7 Marvel Champagne Mosaico Matte 30x30 - 1 1/4" x 1 1/4"  
 ASK8 Marvel Beige Mosaico Matte 30x30 - 1 1/4" x 1 1/4"  
 ASK9 Marvel Bronze Mosaico Matte 30x30 - 1 1/4" x 1 1/4"

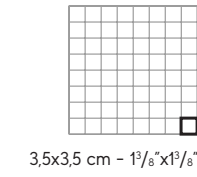

ASMB Marvel Calacatta Mosaico Polished 30x30 - 1 1/4" x 1 1/4"  
 ASMC Marvel Moon Mosaico Polished 30x30 - 1 1/4" x 1 1/4"  
 ASMG Marvel Grey Mosaico Polished 30x30 - 1 1/4" x 1 1/4"  
 ASMD Marvel Champagne Mosaico Polished 30x30 - 1 1/4" x 1 1/4"  
 ASME Marvel Beige Mosaico Polished 30x30 - 1 1/4" x 1 1/4"  
 ASMF Marvel Bronze Mosaico Polished 30x30 - 1 1/4" x 1 1/4"

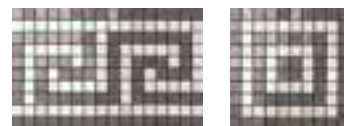
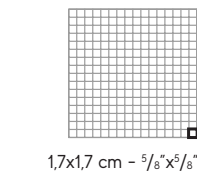

ASM9 Marvel Grey/Moon Greca Mosaico 18,5x30 - 7 1/4" x 1 1/4"  
 ASNB Marvel Grey/Moon Angolo Mosaico 18,5x18,5 - 7 1/4" x 7 1/4"



ASM8 Marvel Bronze/Champagne Greca Mosaico 18,5x30 - 7 1/4" x 1 1/4"  
 ASNA Marvel Bronze/Champagne Angolo Mosaico 18,5x18,5 - 7 1/4" x 7 1/4"

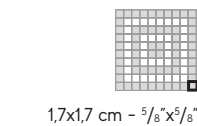
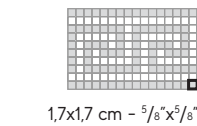

<sup>(1)</sup> Multi-thickness mosaic, close joint installation without grouting. - Mosaico multispessore, posa senza stuccatura a giunto unito. - Mosaik multi-épaisseur, pose sans mastic avec joint nul. - Mosaik mit verschiedenen Stärken, fugenlose Verlegung ohne Mörtel. - Mosaico multiespesor, colocación sin mástique y sin juntas. - Мозаика разной толщины, укладка встык без затирки швов.

The decoration can only be laid on the wall - Il decoro si può posare solo a rivestimento - Décor uniquement mural - Dekor kann nur an der Wand verlegt werden. La decoración se puede colocar únicamente en paredes - Декор может быть уложен только на стену.



INDEX



A COMPLETE PRODUCT SYSTEM



PRODUCT FINDER



SURFACE RANGE



COMPANY



COLLECTIONS



- 3D WALL
- CONCRETE & RESIN LOOK
- METAL LOOK
- MARBLE LOOK
- STONE LOOK
- WOOD LOOK

LARGE SIZES



SLABS FOR COUNTERTOPS & FURNITURE



SINKS & BATHROOM FURNISHING



FACADES



TECHNICAL SPECIFICATIONS



# Marvel

## Wall Tiles

### SHINY SURFACE



± 8,5 mm

50x120 cm - 19<sup>5</sup>/<sub>8</sub>"x47<sup>1</sup>/<sub>4</sub>"  
A4ST Marvel Calacatta Extra

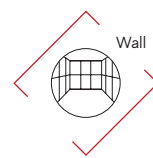

± 8,5 mm

40x80 cm - 15<sup>3</sup>/<sub>4</sub>"x31<sup>1</sup>/<sub>2</sub>"  
8MVA Marvel Calacatta Extra  
8MVC Marvel Champagne Onyx  
8MVS Marvel Silver Dream



± 8,5 mm

30,5x91,5 cm - 12"x36"  
AR5J Marvel Calacatta Extra  
AR5L Marvel Moon Onyx  
AR5N Marvel Silver Dream  
AR5K Marvel Champagne Onyx  
AR5M Marvel Beige Mystery  
AR5O Marvel Bronze Luxury



± 8,5 mm

30,5x56 cm - 12"x22"  
9P5L Marvel Calacatta Extra  
9P5M Marvel Moon Onyx  
9P5S Marvel Silver Dream  
9P5H Marvel Champagne Onyx  
9P5E Marvel Beige Mystery  
9P5O Marvel Bronze Luxury



± 8,5 mm

8x31,5 cm - 3<sup>1</sup>/<sub>8</sub>"x12<sup>3</sup>/<sub>8</sub>"  
LMKC Calacatta Extra Brick



V2 Slight Variation



CALACATTA EXTRA



CHAMPAGNE ONYX

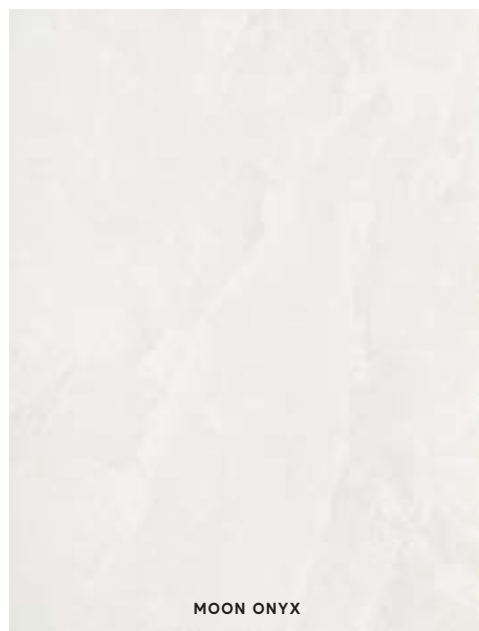

MOON ONYX



BEIGE MYSTERY



SILVER DREAM



BRONZE LUXURY

## DECOR RANGE



ASCC Marvel Moon Line  
30,5x91,5 - 12"x36"



ASCA Marvel Champagne Line  
30,5x91,5 - 12"x36"



ASEN Marvel Champagne Wave  
30,5x91,5 - 12"x36"

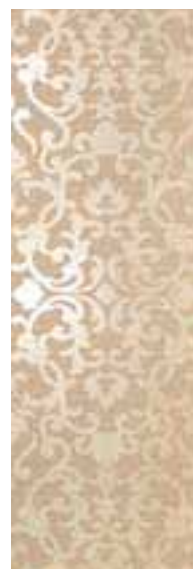

ASCZ Marvel Beige Brocade  
30,5x91,5 - 12"x36"



ASCY Marvel Bronze Brocade  
30,5x91,5 - 12"x36"



ASCD Marvel Bronze Wallpaper  
30,5x91,5 - 12"x36"



ASC6 Marvel Calacatta Lesena  
10x20 - 3<sup>1</sup>/<sub>8</sub>"x7<sup>1</sup>/<sub>8</sub>"



ASC9 Marvel Champagne Terminale Lesena  
10x20 - 3<sup>1</sup>/<sub>8</sub>"x7<sup>1</sup>/<sub>8</sub>"



ASC6 Marvel Calacatta Lesena  
30,5x20 - 12"x7<sup>1</sup>/<sub>8</sub>"



ASC5 Marvel Champagne Lesena  
30,5x20 - 12"x7<sup>1</sup>/<sub>8</sub>"



ASC8 Marvel Calacatta Base Lesena  
20x20 - 7<sup>1</sup>/<sub>8</sub>"x7<sup>1</sup>/<sub>8</sub>"



ASC7 Marvel Champagne Base Lesena  
20x20 - 7<sup>1</sup>/<sub>8</sub>"x7<sup>1</sup>/<sub>8</sub>"



ASDE Marvel Calacatta Fregio  
10x30,5 - 3<sup>1</sup>/<sub>8</sub>"x12"



ASDD Marvel Champagne Fregio  
10x30,5 - 3<sup>1</sup>/<sub>8</sub>"x12"

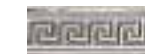

ASEK Marvel Greca Gold <sup>(1)</sup>  
7,8x30,5 - 3<sup>1</sup>/<sub>8</sub>"x12"



ASEM Marvel Greca A.E. <sup>(1)</sup>  
7,8x12 - 3<sup>1</sup>/<sub>8</sub>"x1<sup>1</sup>/<sub>2</sub>"

<sup>(1)</sup> Contains gold. The use of a common mild detergent is recommended. Avoid using acidic or alkaline products, waxes, steel wool or abrasives. - Parti in oro. Si consiglia l'utilizzo di un comune detergente neutro. Evitare l'utilizzo di prodotti acidi o alcalini, ceranti, pagliette di metallo o abrasive. - Parties dorées. Nous vous conseillons d'utiliser des détergents neutres courants. Éviter l'utilisation de cires et de produits acides ou alcalins, ainsi que les pailles métalliques ou abrasives. - Teile aus Gold. Es empfiehlt sich, ein haushaltsübliches, neutrales Reinigungsmittel zu verwenden. Saure oder alkalische Produkte, Wachs sowie Metallwolle- bzw. Scheuerschwämme sind zu vermeiden. - Partes doradas. Recomendamos utilizar un detergente neutro común. Hay que evitar el uso de productos ácidos o alcalinos, ceras y estropajos de metal o abrasivos. - Золотые детали. Рекомендуется чистить обычным нейтральным моющим средством. Не рекомендуется использовать кислотные, щелочные, восковые средства, а также металлические мочалки.

INDEX



A COMPLETE PRODUCT SYSTEM



PRODUCT FINDER



SURFACE RANGE



COMPANY



COLLECTIONS



3D WALL  
CONCRETE & RESIN LOOK  
METAL LOOK  
MARBLE LOOK  
STONE LOOK  
WOOD LOOK

LARGE SIZES



SLABS FOR COUNTERTOPS & FURNITURE



SINKS & BATHROOM FURNISHING



FACADES



TECHNICAL SPECIFICATIONS



# Marvel

## Wall Tiles

### DECOR RANGE

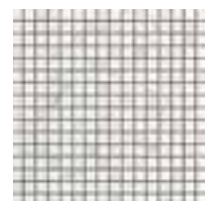

ASCM Marvel Calacatta Mosaic <sup>(2)</sup>  
30,5x30,5 - 12"x12"

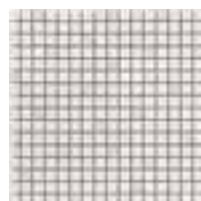

ASCO Marvel Moon Mosaic <sup>(2)</sup>  
30,5x30,5 - 12"x12"



ASCR Marvel Silver Mosaic <sup>(2)</sup>  
30,5x30,5 - 12"x12"



ASCS Marvel Bronze Mosaic <sup>(2)</sup>  
30,5x30,5 - 12"x12"



ASCT Marvel Bronze Gold Mosaic <sup>(2)(3)</sup>  
30,5x30,5 - 12"x12"

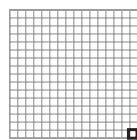

17x17 cm  
5/8"x5/8"

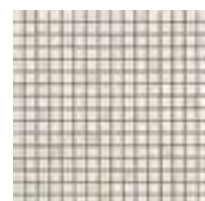

ASCN Marvel Champagne Mosaic <sup>(2)</sup>  
30,5x30,5 - 12"x12"

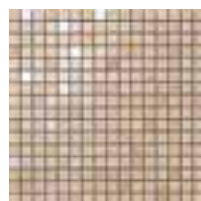

ASCQ Marvel Beige Mosaic <sup>(2)</sup>  
30,5x30,5 - 12"x12"



ASCV Marvel Silver Net Mosaic <sup>(2)</sup>  
30,5x30,5 - 12"x12"



ASCX Marvel Beige Net Mosaic <sup>(2)</sup>  
30,5x30,5 - 12"x12"



ASCW Marvel Bronze Net Mosaic <sup>(2)</sup>  
30,5x30,5 - 12"x12"

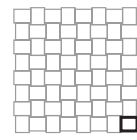

3,3x3,9 cm  
1 1/4"x1 1/2"

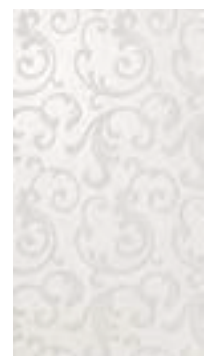

ASC1 Marvel Moon Damask <sup>(1)</sup>  
30,5x56 - 12"x22"

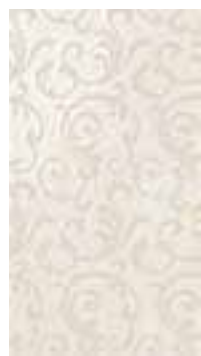

ASCØ Marvel Champagne Damask  
30,5x56 - 12"x22"



ASC4 Marvel Silver Stripe  
30,5x56 - 12"x22"



ASC3 Marvel Beige Stripe  
30,5x56 - 12"x22"

<sup>(1)</sup> Also matching with Calacatta Extra. - Abbinabile anche al Calacatta Extra - Combinable également avec Calacatta Extra - Kombinierbar auch mit Calacatta Extra - Combinable también con Calacatta Extra. - Совместимо также с Calacatta Extra.

<sup>(2)</sup> Matching with both sizes 30,5x91,5 and 30,5x56. - Abbinabili a entrambi i formati 30,5x91,5 e 30,5x56 - Combinables avec les deux formats 30,5x91,5 et 30,5x56. - Kombinierbar mit den beiden Formaten 30,5x91,5 und 30,5x56. - Combinables con ambos formatos 30,5x91,5 y 30,5x56. - Совместимо с обоими форматами: 30,5x91,5 и 30,5x56.

<sup>(3)</sup> Contains gold. The use of a common mild detergent is recommended. Avoid using acidic or alkaline products, waxes, steel wool or abrasives. - Parti in oro. Si consiglia l'utilizzo di un comune detergente neutro. Evitare l'utilizzo di prodotti acidi o alcalini, ceranti, pagliette di metallo o abrasive. - Parties dorées. Nous vous conseillons d'utiliser des détergents neutres courants. Éviter l'utilisation de cires et de produits acides ou alcalins, ainsi que les pailles métalliques ou abrasives - Teile aus Gold. Es empfiehlt sich, ein haushaltsübliches, neutrales Reinigungsmittel zu verwenden. Saure oder alkalische Produkte, Wachs sowie Metallwolle- bzw. Scheuerschwämme sind zu vermeiden. - Partes doradas. Recomendamos utilizar un detergente neutro común. Hay que evitar el uso de productos ácidos o alcalinos, ceras y estropajos de metal o abrasivos. - Золотые детали. Рекомендуется чистить обычным нейтральным моющим средством. Не рекомендуется использовать кислотные, щелочные, восковые средства, а также металлические мочалки.



© Ceramiche Atlas Concorde



© Ceramiche Atlas Concorde

INDEX



A COMPLETE PRODUCT SYSTEM



PRODUCT FINDER



SURFACE RANGE



COMPANY



COLLECTIONS



3D WALL  
CONCRETE & RESIN LOOK  
METAL LOOK  
MARBLE LOOK  
STONE LOOK  
WOOD LOOK

LARGE SIZES



SLABS FOR COUNTERTOPS & FURNITURE



SINKS & BATHROOM FURNISHING



FACADES



TECHNICAL SPECIFICATIONS



# Marvel Dream

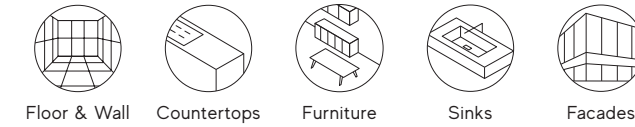

© Ceramiche Atlas Concorde



© Ceramiche Atlas Concorde



© Ceramiche Atlas Concorde



## Porcelain Tiles RECTIFIED MONOCALIBER

Sizes	Thickness	Surface finish
120x278 cm - 47 <sup>1</sup> / <sub>4</sub> "x109 <sup>1</sup> / <sub>2</sub> "	± 6 mm	Polished   Matte <b>R9 A</b>
120x240 cm - 47 <sup>1</sup> / <sub>4</sub> "x94 <sup>1</sup> / <sub>2</sub> "	± 9 mm	Polished
120x120 cm - 47 <sup>1</sup> / <sub>4</sub> "x47 <sup>1</sup> / <sub>4</sub> "	± 9 mm	Polished   Matte <b>Sensitech R10 B</b>
60x120 cm - 23 <sup>5</sup> / <sub>8</sub> "x47 <sup>1</sup> / <sub>4</sub> "	± 9 mm	Polished   Matte <b>Sensitech R10 B</b>
75x150 cm - 29 <sup>1</sup> / <sub>2</sub> "x59"	± 9 mm	Polished   Matte <b>Sensitech R10 B</b>
75x75 cm - 29 <sup>1</sup> / <sub>2</sub> "x29 <sup>1</sup> / <sub>2</sub> "	± 9 mm	Polished   Matte <b>Sensitech R10 B</b>
60x60 cm - 23 <sup>5</sup> / <sub>8</sub> "x23 <sup>5</sup> / <sub>8</sub> "	± 9 mm	Polished   Matte <b>Sensitech R10 B</b>

LARGE SIZES P. 356

## atlasPLAN

### SLABS FOR COUNTERTOPS & FURNITURE

162x324 cm - 63 <sup>3</sup> / <sub>4</sub> "x127 <sup>1</sup> / <sub>2</sub> " NON-RECTIFIED	± 12 mm	Polished   Silk
--	---------	-----------------

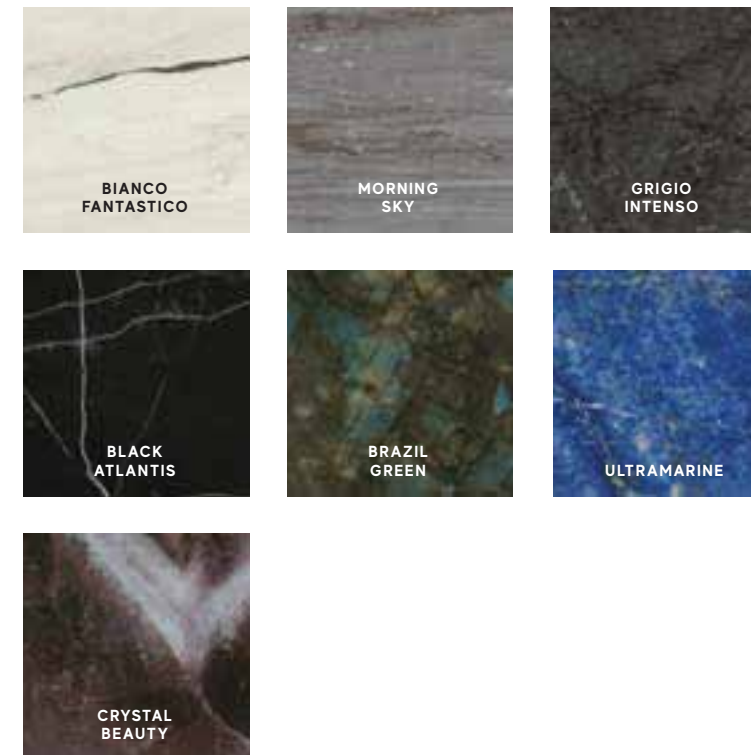

## Wall Tiles RECTIFIED MONOCALIBER

Sizes	Thickness	Surface finish
50x120 cm - 19 <sup>5</sup> / <sub>8</sub> "x47 <sup>1</sup> / <sub>4</sub> "	± 8,5 mm	Shiny

INDEX



A COMPLETE PRODUCT SYSTEM



PRODUCT FINDER



SURFACE RANGE



COMPANY



COLLECTIONS



3D WALL  
CONCRETE & RESIN LOOK  
METAL LOOK  
MARBLE LOOK  
STONE LOOK  
WOOD LOOK

LARGE SIZES



SLABS FOR COUNTERTOPS & FURNITURE



SINKS & BATHROOM FURNISHING



FACADES



TECHNICAL SPECIFICATIONS



# Marvel Dream

## Porcelain Tiles

### POLISHED SURFACE <sup>(1)</sup>



± 6 mm  
120x278 cm - 47 1/4" x 109 1/2"

AOSE Marvel Bianco Fantastico Polished  
AOSF Marvel Grigio Intenso Polished  
AOSG Marvel Black Atlantis Polished  
AL2I Marvel Ultramarine Polished <sup>(2)</sup>



± 9 mm  
120x240 cm - 47 1/4" x 94 1/2"

AO3P Marvel Bianco Fantastico Polished  
AO3Q Marvel Grigio Intenso Polished  
AO3R Marvel Black Atlantis Polished



± 9 mm  
120x120 cm - 47 1/4" x 47 1/4"

AL7N Marvel Bianco Fantastico Polished  
AL7O Marvel Grigio Intenso Polished  
AL7P Marvel Black Atlantis Polished

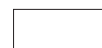

± 9 mm  
60x120 cm - 23 5/8" x 47 1/4"

A21J Marvel Bianco Fantastico Polished  
A21I Marvel Black Atlantis Polished



± 9 mm  
60x60 cm - 23 5/8" x 23 5/8"

AL2N Marvel Bianco Fantastico Polished  
AL7L Marvel Grigio Intenso Polished  
AL2O Marvel Morning Sky Polished  
AL7M Marvel Black Atlantis Polished



± 9 mm  
75x150 cm - 29 1/2" x 59"

A7FS Marvel Bianco Fantastico Polished  
A7FU Marvel Grigio Intenso Polished  
A7FT Marvel Morning Sky Polished  
A7FV Marvel Black Atlantis Polished  
A7FQ Marvel Ultramarine Polished  
A7FR Marvel Brazil Green Polished



± 9 mm  
75x75 cm - 29 1/2" x 29 1/2"

AORW Marvel Bianco Fantastico Polished  
AORY Marvel Grigio Intenso Polished  
AORX Marvel Morning Sky Polished  
AORZ Marvel Black Atlantis Polished  
AL2G Marvel Ultramarine Polished  
AL2H Marvel Brazil Green Polished

### MATTE SURFACE



± 6 mm  
120x278 cm - 47 1/4" x 109 1/2"

A2RR Marvel Bianco Fantastico  
A2RQ Marvel Black Atlantis



± 9 mm  
120x120 cm - 47 1/4" x 47 1/4"

A2Ø3 Marvel Bianco Fantastico  
A2ØZ Marvel Black Atlantis

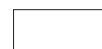

± 9 mm  
60x120 cm - 23 5/8" x 47 1/4"

A21B Marvel Bianco Fantastico  
A21A Marvel Black Atlantis



± 9 mm  
60x60 cm - 23 5/8" x 23 5/8"

AL2J Marvel Bianco Fantastico  
AL2L Marvel Grigio Intenso  
AL2K Marvel Morning Sky  
AL2M Marvel Black Atlantis



± 9 mm  
75x150 cm - 29 1/2" x 59"

A7HY Marvel Bianco Fantastico  
A7HØ Marvel Grigio Intenso  
A7HZ Marvel Morning Sky  
A7H1 Marvel Black Atlantis



± 9 mm  
75x75 cm - 29 1/2" x 29 1/2"

AOR4 Marvel Bianco Fantastico  
AOR6 Marvel Grigio Intenso  
AOR5 Marvel Morning Sky  
AOR7 Marvel Black Atlantis

<sup>(1)</sup> The glossy polished finish is suitable for residential or low-traffic commercial floors, where no anti-slip performance is required, and for walls. The polished glossy surface finish, surprisingly brilliant and bright, features slight irregularities typical of natural marble. The extraordinary brilliance and the easy cleaning of the surface are the result of in-depth research aimed at guaranteeing its durability over time. If the product is in direct contact with the outdoors, provide devices for absorbing moisture and dirt to prevent scratches. - La finitura lappata lucida è indicata per pavimenti residenziali o commerciali poco sollecitati, laddove non siano richieste prestazioni antiscivolo, e per rivestimenti. La finitura lappata lucida offre una superficie sorprendentemente brillante e specchiante, con lievi irregolarità tipiche dei marmi naturali. La straordinaria lucentezza e l'elevata pulibilità della superficie sono frutto di studi approfonditi e accurate ricerche tecniche volte a garantirne la persistenza nel tempo. Se il prodotto è a diretto contatto con l'esterno, prevedere dei dispositivi di assorbimento dell'umidità e della sporcizia per prevenire la formazione di graffi.

<sup>(2)</sup> Ultramarine 120x278 cm: glazed porcelain tiles - Ultramarine 120x278 cm: gres porcellanato smaltato - Ultramarine 120x278 cm: carreaux en grès cérame émaillé - Ultramarine 120x278 cm: mosaico de gres porcelánico esmaltado - Ultramarine 120x278 cm: глазурованный керамогранит.

### COMPLETE YOUR PROJECT



Countertops  
P.402  
162x324 cm  
NON-RECTIFIED



Furniture  
P.356



Sinks  
P.412



Facades  
P.436

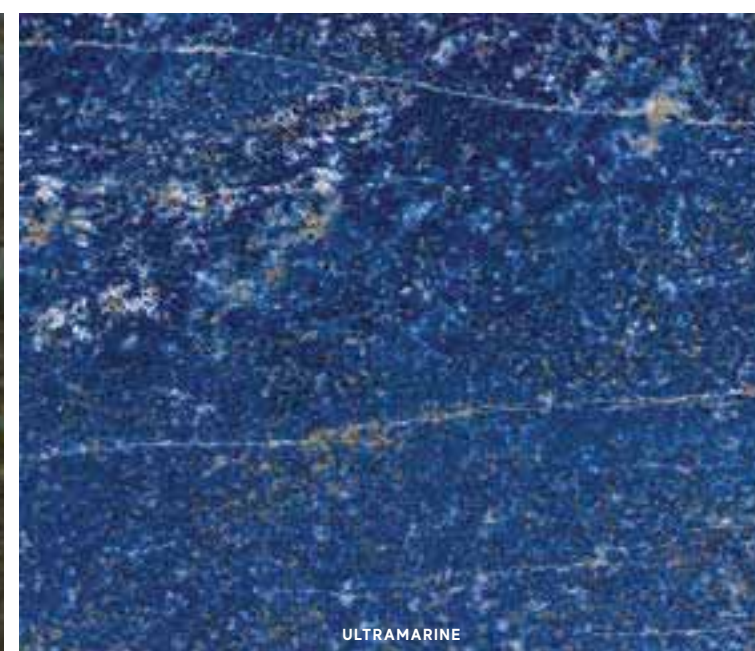
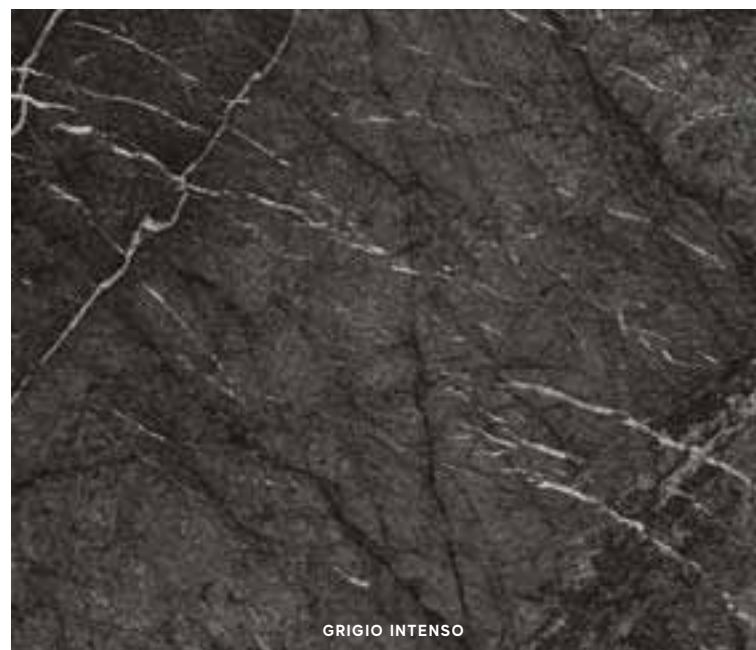
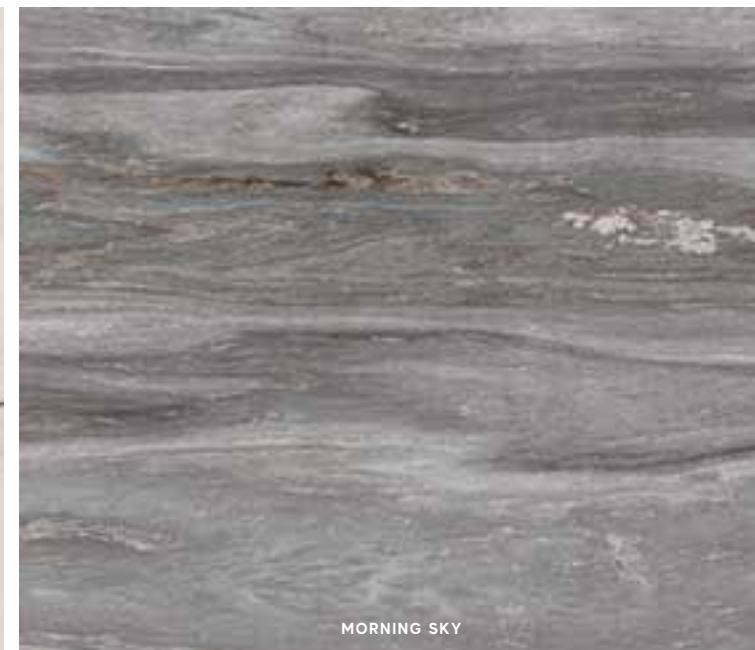

INDEX



A COMPLETE PRODUCT SYSTEM



PRODUCT FINDER



SURFACE RANGE



COMPANY



COLLECTIONS



3D WALL  
CONCRETE & RESIN LOOK  
METAL LOOK  
MARBLE LOOK  
STONE LOOK  
WOOD LOOK

LARGE SIZES



SLABS FOR COUNTERTOPS & FURNITURE



SINKS & BATHROOM FURNISHING



FACADES



TECHNICAL SPECIFICATIONS





# Marvel Dream

## Porcelain Tiles

### DECOR RANGE

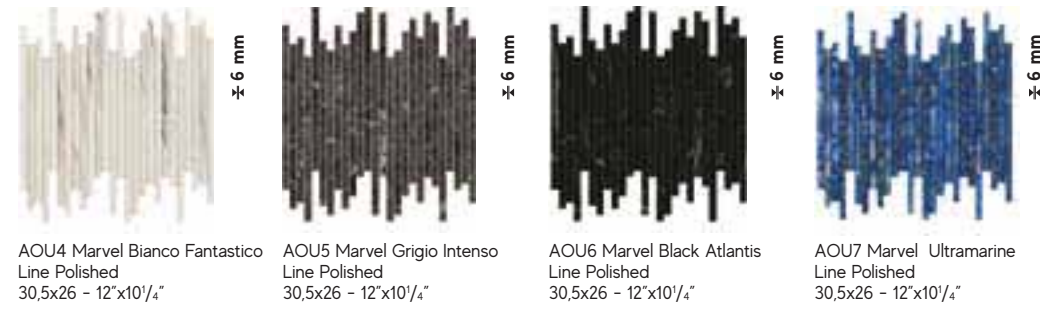

**AOU4** Marvel Bianco Fantastico Line Polished  
30,5x26 - 12"x10 1/4"  
**AOU5** Marvel Grigio Intenso Line Polished  
30,5x26 - 12"x10 1/4"  
**AOU6** Marvel Black Atlantis Line Polished  
30,5x26 - 12"x10 1/4"  
**AOU7** Marvel Ultramarine Line Polished  
30,5x26 - 12"x10 1/4"

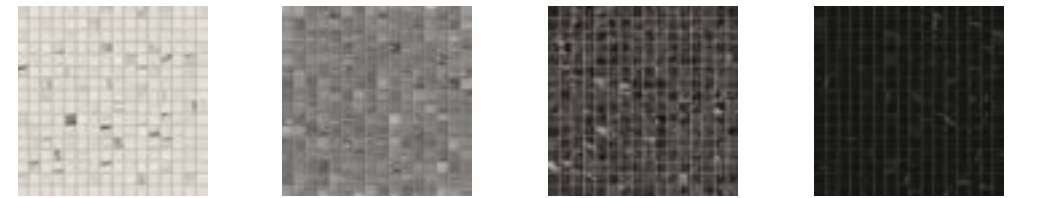

**AOU8** Marvel Bianco Fantastico Mosaico Polished  
30x30 - 11 1/4"x11 1/4"  
**AOU9** Marvel Morning Sky Mosaico Polished  
30x30 - 11 1/4"x11 1/4"  
**AOVA** Marvel Grigio Intenso Mosaico Polished  
30x30 - 11 1/4"x11 1/4"  
**AOVB** Marvel Black Atlantis Mosaico Polished  
30x30 - 11 1/4"x11 1/4"



**AOVE** Marvel Brazil Green Mosaico Polished  
30x30 - 11 1/4"x11 1/4"  
**AOVD** Marvel Ultramarine Mosaico Polished  
30x30 - 11 1/4"x11 1/4"



**AOVF** Marvel Bianco Fantastico Mosaico Matte  
30x30 - 11 1/4"x11 1/4"  
**AOVG** Marvel Morning Sky Mosaico Matte  
30x30 - 11 1/4"x11 1/4"  
**AOVH** Marvel Grigio Intenso Mosaico Matte  
30x30 - 11 1/4"x11 1/4"  
**AOVI** Marvel Black Atlantis Mosaico Matte  
30x30 - 11 1/4"x11 1/4"

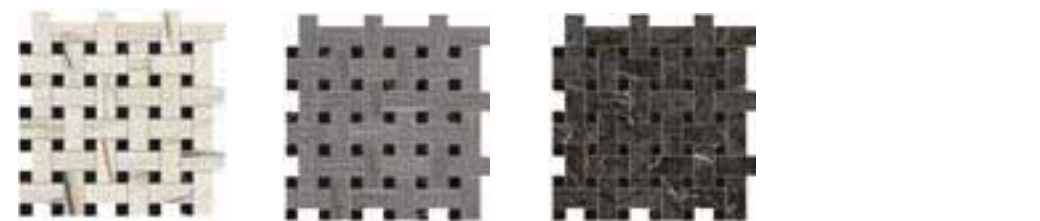

**AOVJ** Marvel Bianco Fantastico Basket Weave Matte  
30,5x30,5 - 12"x12"  
**AOVL** Marvel Morning Sky Basket Weave Matte  
30,5x30,5 - 12"x12"  
**AOVK** Marvel Grigio Intenso Basket Weave Matte  
30,5x30,5 - 12"x12"

Bianco Fantastico + Black Atlantis

Morning Sky + Black Atlantis

Grigio Intenso + Black Atlantis

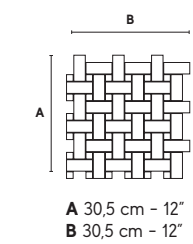
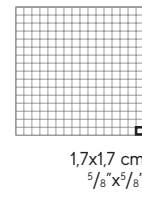
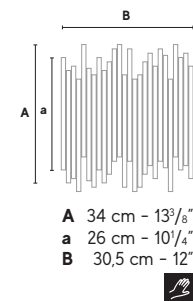

**AOYQ** Marvel Bianco Fantastico Liberty Polished  
31,8x26,1 - 12 1/2"x10 1/4"  
**AOYR** Marvel Morning Sky Liberty Polished  
31,8x26,1 - 12 1/2"x10 1/4"  
**AOYT** Marvel Grigio Intenso Liberty Polished  
31,8x26,1 - 12 1/2"x10 1/4"  
**AOYX** Marvel Brazil Green Liberty Polished  
31,8x26,1 - 12 1/2"x10 1/4"  
**AOYW** Marvel Ultramarine Liberty Polished  
31,8x26,1 - 12 1/2"x10 1/4"

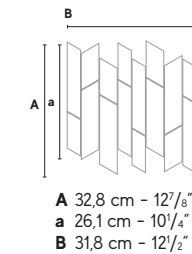

**AOYY** Marvel Bianco Fantastico Hex  
25,4x29,6 - 10"x11 1/8"  
**AOYZ** Marvel Morning Hex  
25,4x29,6 - 10"x11 1/8"  
**AOYØ** Grigio Intenso Hex  
25,4x29,6 - 10"x11 1/8"  
**AOY1** Black Atlantis Hex  
25,4x29,6 - 10"x11 1/8"

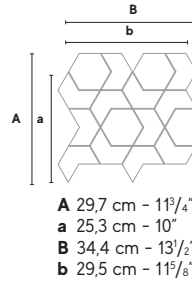

**AOVO** Marvel Brazil Green Leaf Polished  
42,3x27,2 - 16 2/3"x10 5/8"  
**AOVN** Marvel Ultramarine Leaf Polished  
42,3x27,2 - 16 2/3"x10 5/8"

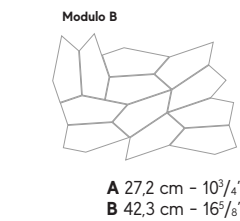
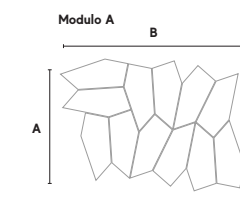

### TRIM TILES p. 352

	Battiscopa				Scalino *				Scalino Ang.*				Scalin Ang.*				Battiscopa Sag. Scala *					
	7,2x150 cm 2 7/8"x59"		7,2x60 cm 2 7/8"x23 3/8"		37,5x150 cm 14 3/4"x59"		33x60 cm 13"x23 3/8"		37,5x37,5 cm 14 3/4"x14 3/4"		33x33 cm 13"x13"		7,2x30 cm - 2 7/8"x11 1/4"		7,2x30 cm - 2 7/8"x11 1/4"		7,2x30 cm - 2 7/8"x11 1/4"					
	Polished	Matte	Polished	Matte	Polished	Matte	Polished	Matte	Polished	Matte	Polished	Matte	Polished	Matte	Polished	Matte	Polished	Matte				
Bianco Fantastico	AOWE	AOWA	AOV2	AOV6	AO7L	AO7H	AO7D	AO69	-	-	APAG	APAF	AO95	AO94	-	-	AO9Z	AO9Y	AO9T	AO9S	AOWL	AOWP
Morning Sky	AOWF	AOWB	AOV3	AOV7	AO7M	AO7I	AO7E	AO7A	-	-	APAI	APAH	AO97	AO96	-	-	AO9I	AO9Ø	AO9V	AO9U	AOWM	AOWQ
Grigio Intenso	AOWG	AOWC	AOV4	AOV8	AO7N	AO7J	AO7F	AO7B	AO98	AO92	-	-	-	-	-	-	AO9W	AO9Q	-	-	AOWN	AOWR
Black Atlantis	AOWH	AOWD	AOV5	AOV9	AO7O	AO7K	AO7G	AO7C	AO99	AO93	-	-	-	-	-	-	AO9X	AO9R	-	-	AOWO	AOWS
Ultramarine	AOWJ	-	-	-	AO7Q	-	-	-	APAD	-	-	-	-	-	-	-	-	-	-	-	-	-
Brazil Green	AOWK	-	-	-	AO7R	-	-	-	APAE	-	-	-	-	-	-	-	-	-	-	-	-	-

\* These parts are supplied to order - I pezzi sono disponibili su ordinazione - Les pièces sont disponibles sur commande - Die Teile sind auf Bestellung lieferbar - Las piezas se hacen por encargo - Изготовляются на заказ

The decoration can only be laid on the wall - Il decoro si può posare solo a rivestimento - Décor uniquement mural - Das Dekor kann nur an der Wand verlegt werden - La decoración se puede colocar únicamente en paredes - Декор может быть уложен только на стену.

# Marvel Dream

## Wall Tiles

### SHINY SURFACE



± 8.5 mm

50x120 cm - 19<sup>5</sup>/<sub>8</sub>"x47<sup>1</sup>/<sub>4</sub>"

A4SF Marvel Bianco Fantastico

A4SI Marvel Black Atlantis

A4SJ Marvel Morning Sky

A4SE Marvel Brazil Green

A4SG Marvel Grigio Intenso

A4SK Marvel Crystal Beauty

A4SH Marvel Ultramarine

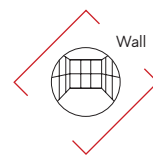

BIANCO FANTASTICO

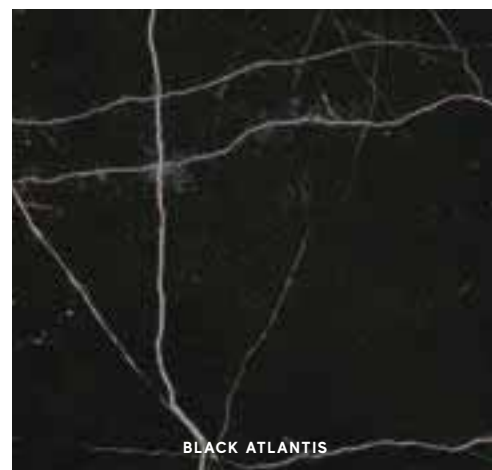

BLACK ATLANTIS



MORNING SKY



BRAZIL GREEN

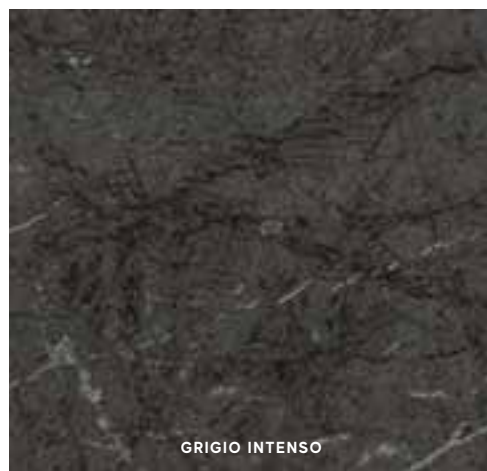

GRIGIO INTENSO



CRYSTAL BEAUTY

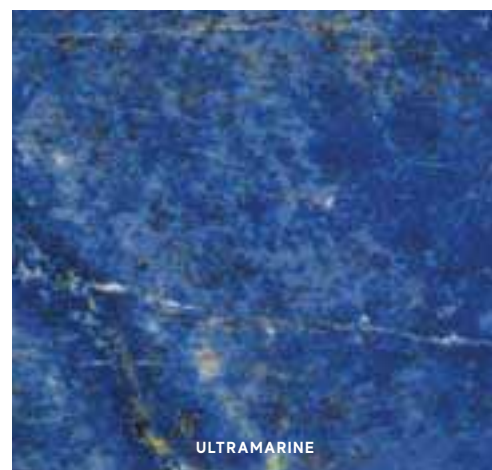

ULTRAMARINE

V2 Slight Variation  
Bianco Fantastico, Grigio Intenso,  
Black Atlantis

V3 Moderate Variation  
Brazil Green, Morning Sky,  
Ultramarine, Crystal Beauty

## DECOR RANGE



9MQI Marvel Bianco Fantastico  
Mosaic Q  
30,5x30,5 - 12"x12"

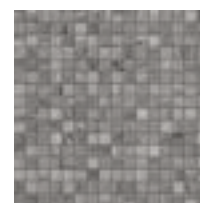

9MQS Marvel Morning Sky  
Mosaic Q  
30,5x30,5 - 12"x12"

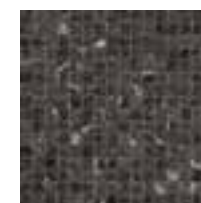

9MQG Marvel Grigio Intenso  
Mosaic Q  
30,5x30,5 - 12"x12"



9MQK Marvel Black Atlantis  
Mosaic Q  
30,5x30,5 - 12"x12"

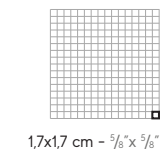

1,7x1,7 cm - 5/8" x 5/8"



9MQH Marvel Brazil Green  
Mosaic Q  
30,5x30,5 - 12"x12"

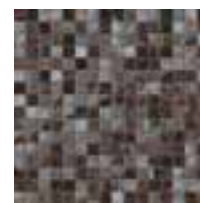

9MQT Marvel Crystal Beauty  
Mosaic Q  
30,5x30,5 - 12"x12"



9MQD Marvel Ultramarine  
Mosaic Q  
30,5x30,5 - 12"x12"



9MFB Marvel Fan  
Bianco Fantastico  
29x29,2 - 11<sup>1</sup>/<sub>8</sub>"x11<sup>1</sup>/<sub>2</sub>"



9MFS Marvel Fan  
Morning Sky  
29x29,2 - 11<sup>1</sup>/<sub>8</sub>"x11<sup>1</sup>/<sub>2</sub>"



9MFG Marvel Fan  
Grigio Intenso  
29x29,2 - 11<sup>1</sup>/<sub>8</sub>"x11<sup>1</sup>/<sub>2</sub>"



9MFK Marvel Fan  
Black Atlantis  
29x29,2 - 11<sup>1</sup>/<sub>8</sub>"x11<sup>1</sup>/<sub>2</sub>"

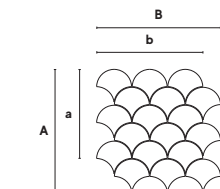

A 33,4 cm - 13<sup>1</sup>/<sub>8</sub>"  
a 29,2 cm - 11<sup>1</sup>/<sub>2</sub>"  
B 33,9 cm - 13<sup>3</sup>/<sub>8</sub>"  
b 29 cm - 11<sup>1</sup>/<sub>8</sub>"



9MFE Marvel Fan  
Brazil Green  
29x29,2 - 11<sup>1</sup>/<sub>8</sub>"x11<sup>1</sup>/<sub>2</sub>"



9MFL Marvel Fan  
Crystal Beauty  
29x29,2 - 11<sup>1</sup>/<sub>8</sub>"x11<sup>1</sup>/<sub>2</sub>"



9MFM Marvel Fan  
Ultramarine  
29x29,2 - 11<sup>1</sup>/<sub>8</sub>"x11<sup>1</sup>/<sub>2</sub>"



9MDB Marvel Diamonds  
Bianco - Black <sup>(1)</sup>  
35,8x32,9 - 14<sup>1</sup>/<sub>8</sub>"x13"



9MDN Marvel Diamonds  
Bianco - Ultramarine <sup>(1)</sup>  
35,8x32,9 - 14<sup>1</sup>/<sub>8</sub>"x13"



9MDG Marvel Diamonds  
Bianco - Green <sup>(1)</sup>  
35,8x32,9 - 14<sup>1</sup>/<sub>8</sub>"x13"

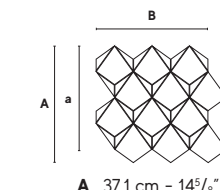

A 37,1 cm - 14<sup>5</sup>/<sub>8</sub>"  
a 32,9 cm - 13"  
B 35,8 cm - 14<sup>1</sup>/<sub>8</sub>"



9MCN Marvel Chevron <sup>(1) (2)</sup>  
Bianco Fantastico  
17x41,4 - 6<sup>3</sup>/<sub>4</sub>"x16<sup>1</sup>/<sub>8</sub>"



9MCO Marvel Chevron <sup>(1) (2)</sup>  
Brazil Green  
17x41,4 - 6<sup>3</sup>/<sub>4</sub>"x16<sup>1</sup>/<sub>8</sub>"



9MCP Marvel Chevron <sup>(1) (2)</sup>  
Ultramarine  
17x41,4 - 6<sup>3</sup>/<sub>4</sub>"x16<sup>1</sup>/<sub>8</sub>"

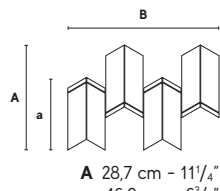

A 28,7 cm - 11<sup>1</sup>/<sub>4</sub>"  
a 16,9 cm - 6<sup>3</sup>/<sub>4</sub>"  
B 41,4 cm - 16<sup>1</sup>/<sub>4</sub>"

## TRIM TILES

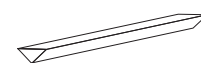

1,4x50 cm - 5/8"x19<sup>5</sup>/<sub>8</sub>"

LD5B Marvel Bianco Fantastico Corner 50 \*

LD5S Marvel Morning Sky Corner 50 \*

LD5G Marvel Grigio Intenso Corner 50 \*

LD5N Marvel Black Atlantis Corner 50 \*

LD5M Marvel Ultramarine Corner 50 \*

LD5E Marvel Brazil Green Corner 50 \*

LD5C Marvel Crystal Beauty Corner 50 \*



1,4x1,4 cm - 5/8"x5/8"

MD1B Marvel Bianco Fantastico Corner A.E. 1,4 \*

MD1S Marvel Morning Sky Corner A.E. 1,4 \*

MD1G Marvel Grigio Intenso Corner A.E. 1,4 \*

MD1N Marvel Black Atlantis Corner A.E. 1,4 \*

MD1M Marvel Ultramarine Corner A.E. 1,4 \*

MD1E Marvel Brazil Green Corner A.E. 1,4 \*

MD1C Marvel Crystal Beauty Corner A.E. 1,4 \*

\* These parts are supplied to order - I pezzi sono disponibili su ordinazione - Les pièces sont disponibles sur commande - Die Teile sind auf Bestellung lieferbar - Las piezas se hacen por encargo - Изготавливаются на заказ

<sup>(1)</sup> Contains gold. The use of a common mild detergent is recommended. Avoid using acidic or alkaline products, waxes, steel wool, or abrasives. - Parti in oro. Si consiglia l'utilizzo di un comune detergente neutro. Evitare l'utilizzo di prodotti acidi o alcalini, ceranti, pagliette di metallo o abrasive. - Parties dorées. Nous vous conseillons d'utiliser des détergents neutres courants. Éviter l'utilisation de cires et de produits acides ou alcalins, ainsi que les pailles métalliques ou abrasives - Teile aus Gold. Es empfiehlt sich, ein haushaltsübliches, neutrales Reinigungsmittel zu verwenden. Saure oder alkalische Produkte, Wachs sowie Metallwolle- bzw. Scheuerschwämme sind zu vermeiden. - Partes doradas. Recomendamos utilizar un detergente neutro común. Hay que evitar el uso de productos ácidos o alcalinos, ceras y estropajos de metal o abrasivos. - Золотые детали. Рекомендуется использовать нейтральным моющим средством. Не рекомендуется использовать кислотные, щелочные, восковые средства, а также металлические мочалки.

<sup>(2)</sup> One of the six sheets in the box contains a golden tile with the Atlas Concorde logo. - Uno dei sei fogli contenuti nella scatola contiene una tessera dorata con logo Atlas Concorde. - Une des six feuilles dans la boîte contient une tesselle dorée avec logo Atlas Concorde. - Eine der sechs Matten im Karton enthält ein goldfarbenes Mosaiksteinchen mit dem Atlas Concorde-Logo. - En la caja encontrarán 6 folios, uno de estos contiene una tarjeta dorada con el logotipo Atlas Concorde. - Один из шести листов, помещенных в коробку, содержит золотую табличку с логотипом Atlas Concorde.

INDEX



A COMPLETE  
PRODUCT  
SYSTEM



PRODUCT  
FINDER



SURFACE  
RANGE



COMPANY



COLLECTIONS



3D WALL  
CONCRETE & RESIN LOOK  
METAL LOOK  
MARBLE LOOK  
STONE LOOK  
WOOD LOOK

LARGE SIZES



SLABS FOR  
COUNTERTOPS  
& FURNITURE



SINKS &  
BATHROOM  
FURNISHING



FACADES



TECHNICAL  
SPECIFICATIONS



# Marvel Edge

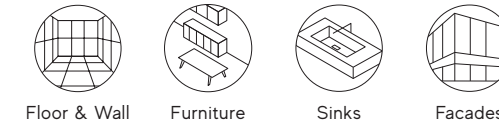

© Ceramiche Atlas Concorde



© Ceramiche Atlas Concorde



© Ceramiche Atlas Concorde

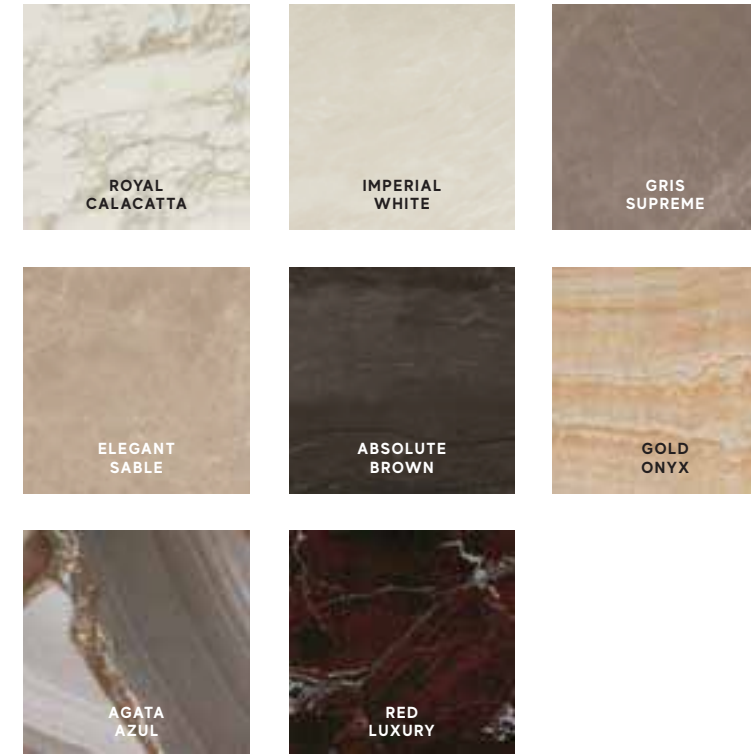

**Porcelain Tiles** RECTIFIED MONOCALIBER

Sizes	Thickness	Surface finish
120x278 cm - 47 <sup>1</sup> / <sub>4</sub> "x109 <sup>1</sup> / <sub>2</sub> "	± 6 mm	Polished
120x240 cm - 47 <sup>1</sup> / <sub>4</sub> "x94 <sup>1</sup> / <sub>2</sub> "	± 9 mm	Polished
120x120 cm - 47 <sup>1</sup> / <sub>4</sub> "x47 <sup>1</sup> / <sub>4</sub> "	± 9 mm	Polished
75x150 cm - 29 <sup>1</sup> / <sub>2</sub> "x59"	± 9 mm	Polished
75x75 cm - 29 <sup>1</sup> / <sub>2</sub> "x29 <sup>1</sup> / <sub>2</sub> "	± 9 mm	Polished
60x60 cm - 23 <sup>5</sup> / <sub>8</sub> "x23 <sup>5</sup> / <sub>8</sub> "	± 9 mm	Polished   Matte <b>Sensitech R10 B</b>
30x60 cm - 11 <sup>1</sup> / <sub>4</sub> "x23 <sup>5</sup> / <sub>8</sub> "	± 9 mm	Polished   Matte <b>Sensitech R10 B</b>

**LARGE SIZES** p. 356

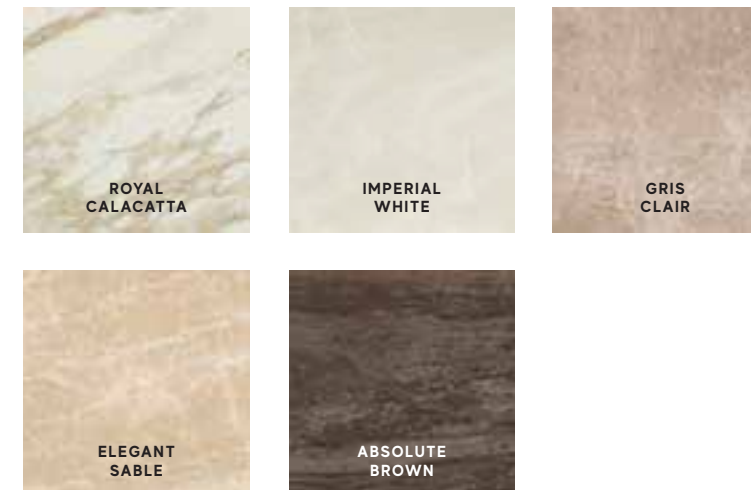

**Wall Tiles** RECTIFIED MONOCALIBER

Sizes	Thickness	Surface finish
50x120 cm - 19 <sup>5</sup> / <sub>8</sub> "x47 <sup>1</sup> / <sub>4</sub> "	± 8,5 mm	Shiny
40x80 cm - 15 <sup>5</sup> / <sub>8</sub> "x31 <sup>1</sup> / <sub>2</sub> "	± 8,5 mm	Shiny

INDEX

A COMPLETE PRODUCT SYSTEM

PRODUCT FINDER

SURFACE RANGE

COMPANY

COLLECTIONS

- 3D WALL
- CONCRETE & RESIN LOOK
- METAL LOOK
- MARBLE LOOK
- STONE LOOK
- WOOD LOOK

LARGE SIZES

SLABS FOR COUNTERTOPS & FURNITURE

SINKS & BATHROOM FURNISHING

FACADES

TECHNICAL SPECIFICATIONS

# Marvel Edge

## Porcelain Tiles



Polished  $\pm 6$  mm  
Polished  $\pm 9$  mm



Matte  $\pm 9$  mm



R10 B Matte Sensitech (S)  $\pm 9$  mm



V2 Slight Variation  
Imperial White,  
Elegant Sable,  
Gris Supreme



V3 Moderate Variation  
Royal Calacatta,  
Absolute Brown,  
Gold Onyx,  
Agata Azul,  
Red Luxury



### POLISHED SURFACE <sup>(1)</sup>

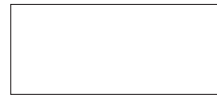

$\pm 6$  mm  
**120x278 cm** - 47<sup>1</sup>/<sub>4</sub>"x109<sup>1</sup>/<sub>2</sub>"  
AØBH Marvel Royal Calacatta Polished  
AØQC Marvel Absolute Brown Polished



$\pm 9$  mm  
**120x240 cm** - 47<sup>1</sup>/<sub>4</sub>"x94<sup>1</sup>/<sub>2</sub>"  
AENU Marvel Royal Calacatta Polished



$\pm 9$  mm  
**120x120 cm** - 47<sup>1</sup>/<sub>4</sub>"x47<sup>1</sup>/<sub>4</sub>"  
AENP Marvel Royal Calacatta Polished  
AENQ Marvel Imperial White Polished  
AENK Marvel Elegant Sable Polished  
AENN Marvel Gris Supreme Polished  
AENO Marvel Absolute Brown Polished



$\pm 9$  mm  
**60x60 cm** - 23<sup>5</sup>/<sub>8</sub>"x23<sup>5</sup>/<sub>8</sub>"  
AEN4 Marvel Royal Calacatta Polished  
AEN5 Marvel Imperial White Polished  
AEN1 Marvel Elegant Sable Polished  
AEN2 Marvel Gris Supreme Polished  
AEN3 Marvel Absolute Brown Polished



$\pm 9$  mm  
**30x60 cm** - 11<sup>1</sup>/<sub>4</sub>"x23<sup>5</sup>/<sub>8</sub>"  
AEN9 Marvel Royal Calacatta Polished  
AEOA Marvel Imperial White Polished  
AEN6 Marvel Elegant Sable Polished  
AEN7 Marvel Gris Supreme Polished  
AEN8 Marvel Absolute Brown Polished



$\pm 9$  mm  
**75x150 cm** - 29<sup>1</sup>/<sub>2</sub>"x59"  
A7FZ Marvel Royal Calacatta Polished  
A7FØ Marvel Imperial White Polished  
A7FW Marvel Elegant Sable Polished  
A7FX Marvel Gris Supreme Polished  
A7FY Marvel Absolute Brown Polished  
A7F1 Marvel Gold Onyx Polished  
A7F2 Marvel Agata Azul Polished  
A7F3 Marvel Red Luxury Polished



$\pm 9$  mm  
**75x75 cm** - 29<sup>1</sup>/<sub>2</sub>"x29<sup>1</sup>/<sub>2</sub>"  
AAIW Marvel Royal Calacatta Polished  
AAIX Marvel Imperial White Polished  
AAIS Marvel Elegant Sable Polished  
AAIT Marvel Gris Supreme Polished  
AAIU Marvel Absolute Brown Polished  
AAIY Marvel Gold Onyx Polished  
AAIØ Marvel Agata Azul Polished  
AAI5 Marvel Red Luxury Polished

### MATTE SURFACE



$\pm 9$  mm  
**60x60 cm** - 23<sup>5</sup>/<sub>8</sub>"x23<sup>5</sup>/<sub>8</sub>"  
AEOE Marvel Royal Calacatta  
AEOF Marvel Imperial White  
AEOB Marvel Elegant Sable  
AEOC Marvel Gris Supreme  
AEOD Marvel Absolute Brown



$\pm 9$  mm  
**30x60 cm** - 11<sup>1</sup>/<sub>4</sub>"x23<sup>5</sup>/<sub>8</sub>"  
AEOJ Marvel Royal Calacatta  
AEOK Marvel Imperial White  
AEOG Marvel Elegant Sable  
AEOH Marvel Gris Supreme  
AEOI Marvel Absolute Brown



<sup>(1)</sup> The glossy polished finish is suitable for residential or low-traffic commercial floors, where no anti-slip performance is required, and for walls. The polished glossy surface finish, surprisingly brilliant and bright, features slight irregularities typical of natural marble. The extraordinary brilliance and the easy cleaning of the surface are the result of in-depth research aimed at guaranteeing its durability over time. If the product is in direct contact with the outdoors, provide devices for absorbing moisture and dirt to prevent scratches. - La finitura lappata lucida è indicata per pavimenti residenziali o commerciali poco sollecitati, laddove non siano richieste prestazioni antiscivolo, e per rivestimenti. La finitura lappata lucida offre una superficie sorprendentemente brillante e specchiante, con lievi irregolarità tipiche dei marmi naturali. La straordinaria lucentezza e l'elevata pulibilità della superficie sono frutto di studi approfonditi e accurate ricerche tecniche volte a garantirne la persistenza nel tempo. Se il prodotto è a diretto contatto con l'esterno, prevedere dei dispositivi di assorbimento dell'umidità e della sporcizia per prevenire la formazione di graffi.

### COMPLETE YOUR PROJECT



Furniture  
P.356



Sinks  
P.412



Facades  
P.436



ROYAL CALACATTA



IMPERIAL WHITE



GRIS SUPREME



ELEGANT SABLE



ABSOLUTE BROWN



GOLD ONYX

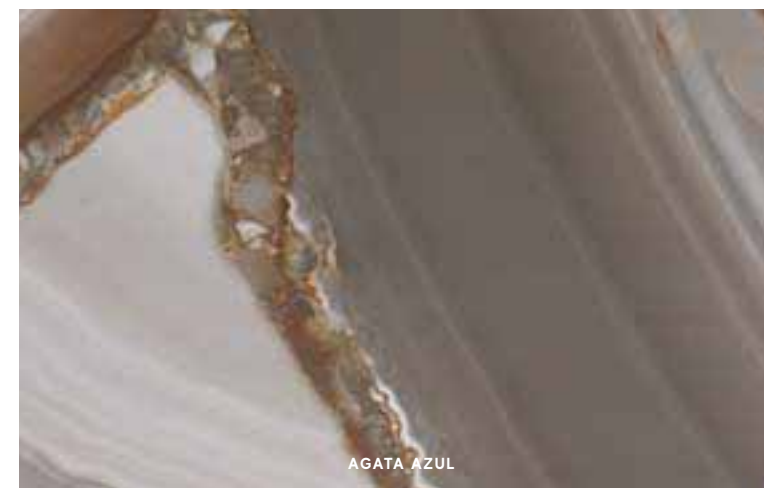

AGATA AZUL



RED LUXURY

INDEX



A COMPLETE  
PRODUCT  
SYSTEM



PRODUCT  
FINDER



SURFACE  
RANGE



COMPANY



COLLECTIONS



3D WALL  
CONCRETE & RESIN LOOK  
METAL LOOK  
MARBLE LOOK  
STONE LOOK  
WOOD LOOK

LARGE SIZES



SLABS FOR  
COUNTERTOPS  
& FURNITURE



SINKS &  
BATHROOM  
FURNISHING



FACADES



TECHNICAL  
SPECIFICATIONS



# Marvel Edge

## Porcelain Tiles

### DECOR RANGE



AEOU Marvel Imperial White  
Mosaico Matte  
30x30 - 1<sup>1</sup>/<sub>4</sub>"x1<sup>1</sup>/<sub>4</sub>"



AEOY Marvel Royal Calacatta  
Mosaico Matte  
30x30 - 1<sup>1</sup>/<sub>4</sub>"x1<sup>1</sup>/<sub>4</sub>"

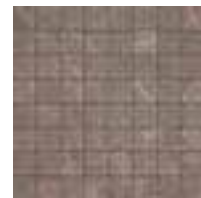

AEOZ Marvel Gris Supreme  
Mosaico Matte  
30x30 - 1<sup>1</sup>/<sub>4</sub>"x1<sup>1</sup>/<sub>4</sub>"



AEO1 Marvel Agata Azul  
Mosaico Polished  
30x30 - 1<sup>1</sup>/<sub>4</sub>"x1<sup>1</sup>/<sub>4</sub>"

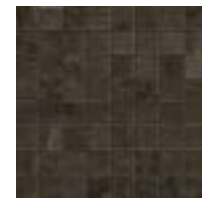

AEO2 Marvel Gold Onyx  
Mosaico Polished  
30x30 - 1<sup>1</sup>/<sub>4</sub>"x1<sup>1</sup>/<sub>4</sub>"

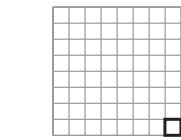

3.5x3.5 cm - 1<sup>1</sup>/<sub>8</sub>"x1<sup>1</sup>/<sub>8</sub>"

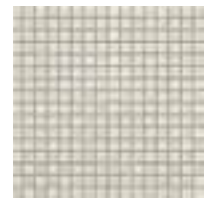

AEOX Marvel Absolute Brown  
Mosaico Polished  
30x30 - 1<sup>1</sup>/<sub>4</sub>"x1<sup>1</sup>/<sub>4</sub>"



AEOY Marvel Royal Calacatta  
Mosaico Polished  
30x30 - 1<sup>1</sup>/<sub>4</sub>"x1<sup>1</sup>/<sub>4</sub>"

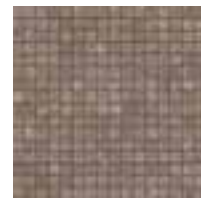

AEOZ Marvel Gris Supreme  
Mosaico Polished  
30x30 - 1<sup>1</sup>/<sub>4</sub>"x1<sup>1</sup>/<sub>4</sub>"



AEO1 Marvel Agata Azul  
Mosaico Polished  
30x30 - 1<sup>1</sup>/<sub>4</sub>"x1<sup>1</sup>/<sub>4</sub>"

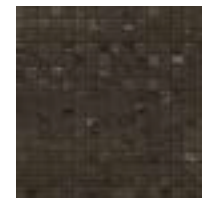

AEO2 Marvel Gold Onyx  
Mosaico Polished  
30x30 - 1<sup>1</sup>/<sub>4</sub>"x1<sup>1</sup>/<sub>4</sub>"

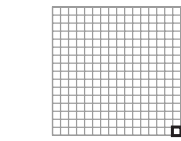

1.7x1.7 cm - 5/8"x5/8"



AEOY Marvel Royal Calacatta  
Mosaico Polished  
30x30 - 1<sup>1</sup>/<sub>4</sub>"x1<sup>1</sup>/<sub>4</sub>"



AEOZ Marvel Gris Supreme  
Mosaico Polished  
30x30 - 1<sup>1</sup>/<sub>4</sub>"x1<sup>1</sup>/<sub>4</sub>"

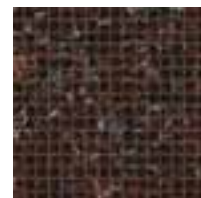

AEO1 Marvel Agata Azul  
Mosaico Polished  
30x30 - 1<sup>1</sup>/<sub>4</sub>"x1<sup>1</sup>/<sub>4</sub>"



AEPN Marvel Imperial White  
Mosaico 3D<sup>(1)</sup>  
30,5x26,4 - 12"x10<sup>3</sup>/<sub>8</sub>"



AEPM Marvel Royal Calacatta  
Mosaico 3D<sup>(1)</sup>  
30,5x26,4 - 12"x10<sup>3</sup>/<sub>8</sub>"



AEPK Marvel Gris Supreme  
Mosaico 3D<sup>(1)</sup>  
30,5x26,4 - 12"x10<sup>3</sup>/<sub>8</sub>"



AEPJ Marvel Elegant Sable  
Mosaico 3D<sup>(1)</sup>  
30,5x26,4 - 12"x10<sup>3</sup>/<sub>8</sub>"



AEPH Marvel Absolute Brown  
Mosaico 3D<sup>(1)</sup>  
30,5x26,4 - 12"x10<sup>3</sup>/<sub>8</sub>"

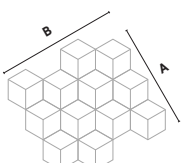

A 26,4 cm - 10<sup>3</sup>/<sub>8</sub>"  
B 30,5 cm - 12"



AEPQ Marvel Gris Supreme  
Mosaico Twill Polished  
30x31 - 1<sup>1</sup>/<sub>4</sub>"x12<sup>1</sup>/<sub>4</sub>"



AEPS Marvel Royal Calacatta  
Mosaico Twill Polished  
30x31 - 1<sup>1</sup>/<sub>4</sub>"x12<sup>1</sup>/<sub>4</sub>"



AEPQ Marvel Gris Supreme  
Mosaico Twill Polished  
30x31 - 1<sup>1</sup>/<sub>4</sub>"x12<sup>1</sup>/<sub>4</sub>"



AEPJ Marvel Elegant Sable  
Mosaico Twill Polished  
30x31 - 1<sup>1</sup>/<sub>4</sub>"x12<sup>1</sup>/<sub>4</sub>"



AEPH Marvel Absolute Brown  
Mosaico Twill Polished  
30x31 - 1<sup>1</sup>/<sub>4</sub>"x12<sup>1</sup>/<sub>4</sub>"

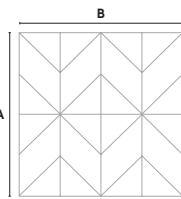

A 36,5 cm - 14<sup>3</sup>/<sub>8</sub>"  
B 36,5 cm - 14<sup>3</sup>/<sub>8</sub>"



AEPU Marvel Gris-Calacatta  
Mosaico Cubes Polished  
36,5x36,5 - 14<sup>3</sup>/<sub>8</sub>"x14<sup>3</sup>/<sub>8</sub>"

<sup>(1)</sup> Multi-thickness mosaic, close joint installation without grouting. - Mosaico multispessore, posa senza stuccatura a giunto unito. - Мозаика multi-épaisseur, pose sans mastic avec joint nul. - Мозаик mit verschiedenen Stärken, fugenlose Verlegung ohne Mörtel. - Mosaico multiespesor, colocación sin mástico y sin juntas. - Мозаика разной толщины, укладка встык без затирки швов.

The decoration can only be laid on the wall. - Il decoro si può posare solo a rivestimento. - Décor uniquement mural. - Das Dekor kann nur an der Wand verlegt werden. - La decoración se puede colocar únicamente en paredes. - Декор может быть уложен только на стену.



AEPN Marvel Imperial White  
Mosaico Esagono Polished  
30x35 - 1<sup>1</sup>/<sub>4</sub>"x13<sup>3</sup>/<sub>4</sub>"



AEPM Marvel Royal Calacatta  
Mosaico Esagono Polished  
30x35 - 1<sup>1</sup>/<sub>4</sub>"x13<sup>3</sup>/<sub>4</sub>"



AEPK Marvel Gris Supreme  
Mosaico Esagono Polished  
30x35 - 1<sup>1</sup>/<sub>4</sub>"x13<sup>3</sup>/<sub>4</sub>"



AEPJ Marvel Elegant Sable  
Mosaico Esagono Polished  
30x35 - 1<sup>1</sup>/<sub>4</sub>"x13<sup>3</sup>/<sub>4</sub>"



AEPH Marvel Absolute Brown  
Mosaico Esagono Polished  
30x35 - 1<sup>1</sup>/<sub>4</sub>"x13<sup>3</sup>/<sub>4</sub>"

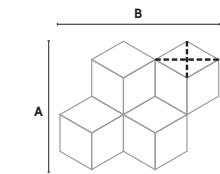

10x17 cm - 3<sup>7</sup>/<sub>8</sub>"x6<sup>3</sup>/<sub>4</sub>"

A 30 cm - 11<sup>1</sup>/<sub>4</sub>"  
B 35 cm - 13<sup>3</sup>/<sub>4</sub>"



AEPN Marvel Imperial White  
Mosaico Twill Polished  
30x31 - 1<sup>1</sup>/<sub>4</sub>"x12<sup>1</sup>/<sub>4</sub>"

Imperial White +  
Gris Supreme



AEPS Marvel Royal Calacatta  
Mosaico Twill Polished  
30x31 - 1<sup>1</sup>/<sub>4</sub>"x12<sup>1</sup>/<sub>4</sub>"

Royal Calacatta +  
Gris Supreme



AEPQ Marvel Gris Supreme  
Mosaico Twill Polished  
30x31 - 1<sup>1</sup>/<sub>4</sub>"x12<sup>1</sup>/<sub>4</sub>"

Gris Supreme +  
Royal Calacatta



AEPJ Marvel Elegant Sable  
Mosaico Twill Polished  
30x31 - 1<sup>1</sup>/<sub>4</sub>"x12<sup>1</sup>/<sub>4</sub>"

Elegante Sable +  
Absolute Brown



AEPH Marvel Absolute Brown  
Mosaico Twill Polished  
30x31 - 1<sup>1</sup>/<sub>4</sub>"x12<sup>1</sup>/<sub>4</sub>"

Absolute Brown +  
Elegant Sable

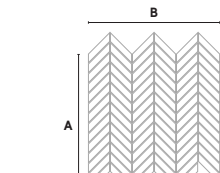

A 31 cm - 12<sup>1</sup>/<sub>4</sub>"  
B 30 cm - 11<sup>1</sup>/<sub>4</sub>"

### TRIM TILES p. 352

	Battiscopa				Gradino *	Scalino *	Scalino *	Scalino Ang. *	Battiscopa Sag. Scala *	
	7,2x60 cm 2 <sup>7</sup> / <sub>8</sub> "x23 <sup>3</sup> / <sub>4</sub> "		Digitale 4,6x60 cm 1 <sup>7</sup> / <sub>4</sub> "x23 <sup>3</sup> / <sub>4</sub> "		30x60 cm 11 <sup>1</sup> / <sub>4</sub> "x23 <sup>3</sup> / <sub>4</sub> "	33x150 cm 13"x59"	33x60 cm 13"x23 <sup>3</sup> / <sub>4</sub> "	33x33 cm 13"x13"	7,2x30 cm 2 <sup>7</sup> / <sub>8</sub> "x11 <sup>1</sup> / <sub>4</sub> "	
	Polished	Matte	Polished	Matte	Matte	Polished	Polished	Matte	Matte	
Elegant Sable	AFA9	AFA4	AFBO	AFBH	AFB4	AFCO	AFCE	AFB9	DX	SX
Gris Supreme	AFBA	AFA5	AFBP	AFBJ	AFB5	AFCP	AFCF	AFCA	AFB2	AFBZ
Absolute Brown	AFBC	AFA6	AFBQ	AFBK	AFB6	AFCO	AFCG	AFCB	AFB3	AFBØ
Royal Calacatta	AFBD	AFA7	AFBR	AFBN	AFB7	AFCR	AFCH	AFCC	AFB4	AFB1
Imperial White	AFBF	AFA8	AFBS	AFBN	AFB8	AFCS	AFCI	AFCD	AFB5	AFB2
Gold Onyx	-	-	-	-	-	AFCT	-	-	AFB6	AFB3
Agata Azul	-	-	-	-	-	AFCU	-	-	AFB7	AFB4
Red Luxury	-	-	-	-	-	AFCV	-	-	AFB8	AFB5

\* These parts are supplied to order - I pezzi sono disponibili su ordinazione - Les pièces sont disponibles sur commande - Die Teile sind auf Bestellung lieferbar - Las piezas se hacen por encargo - Изготавливаются на заказ

# Marvel Edge

## Wall Tiles

### SHINY SURFACE



± 8,5 mm

**50x120 cm** - 19<sup>5</sup>/<sub>8</sub>"x47<sup>1</sup>/<sub>4</sub>"  
 A4SL Marvel Royal Calacatta  
 A4SN Marvel Imperial White  
 A4SM Marvel Elegant Sable

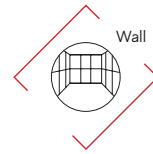

± 8,5 mm

**40x80 cm** - 15<sup>5</sup>/<sub>4</sub>"x31<sup>1</sup>/<sub>2</sub>"  
 9MER Marvel Royal Calacatta  
 9MEW Marvel Imperial White  
 9EMG Marvel Gris Clair  
 9MES Marvel Elegant Sable  
 9MEB Marvel Absolute Brown



ROYAL CALACATTA



IMPERIAL WHITE



GRIS CLAIR



ELEGANT SABLE



ABSOLUTE BROWN



V2 Slight Variation  
 Imperial White, Elegant Sable,  
 Gris Clair



V3 Moderate Variation  
 Royal Calacatta,  
 Absolute Brown

### DECOR RANGE



9EQW Marvel Imperial White  
 Mosaic Q  
 30,5x30,5 - 12"x12"

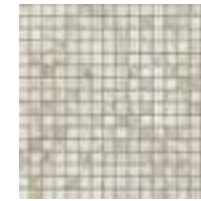

9EQC Marvel Royal Calacatta  
 Mosaic Q  
 30,5x30,5 - 12"x12"



9EQG Marvel Gris Clair  
 Mosaic Q  
 30,5x30,5 - 12"x12"



9EQS Marvel Elegant Sable  
 Mosaic Q  
 30,5x30,5 - 12"x12"



9EQB Marvel Absolute Brown  
 Mosaic Q  
 30,5x30,5 - 12"x12"

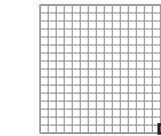

1,7x1,7 cm - 5<sup>5</sup>/<sub>8</sub>"x2<sup>1</sup>/<sub>8</sub>"



9EDW Marvel Imperial White  
 Drop Mosaic  
 27,2x29,7 - 10<sup>7</sup>/<sub>8</sub>"x11<sup>5</sup>/<sub>8</sub>"



9EDC Marvel Royal Calacatta  
 Drop Mosaic  
 27,2x29,7 - 10<sup>7</sup>/<sub>8</sub>"x11<sup>5</sup>/<sub>8</sub>"



9EDR Marvel Gris Clair  
 Drop Mosaic  
 27,2x29,7 - 10<sup>7</sup>/<sub>8</sub>"x11<sup>5</sup>/<sub>8</sub>"



9EDS Marvel Elegant Sable  
 Drop Mosaic  
 27,2x29,7 - 10<sup>7</sup>/<sub>8</sub>"x11<sup>5</sup>/<sub>8</sub>"



9EDB Marvel Absolute Brown  
 Drop Mosaic  
 27,2x29,7 - 10<sup>7</sup>/<sub>8</sub>"x11<sup>5</sup>/<sub>8</sub>"

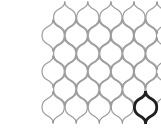

8x5,8 cm - 3<sup>1</sup>/<sub>8</sub>"x2<sup>1</sup>/<sub>4</sub>"



9EHG Marvel Gold Hex <sup>(1)</sup>  
 Gris-Calacatta  
 25,1x29 - 9<sup>7</sup>/<sub>8</sub>"x11<sup>5</sup>/<sub>8</sub>"



9EHB Marvel Gold Hex <sup>(1)</sup>  
 Brown-Calacatta  
 25,1x29 - 9<sup>7</sup>/<sub>8</sub>"x11<sup>5</sup>/<sub>8</sub>"



9EHS Marvel Gold Hex <sup>(1)</sup>  
 Sable-Brown  
 25,1x29 - 9<sup>7</sup>/<sub>8</sub>"x11<sup>5</sup>/<sub>8</sub>"

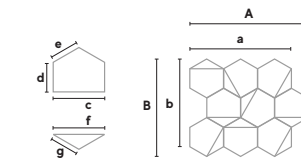

c 9,5 cm - 3<sup>3</sup>/<sub>4</sub>"  
 d 5,4 cm - 2<sup>1</sup>/<sub>8</sub>"  
 e 5,5 cm - 2<sup>1</sup>/<sub>8</sub>"  
 f 9,2 cm - 3<sup>5</sup>/<sub>8</sub>"  
 g 5,3 cm - 2<sup>1</sup>/<sub>8</sub>"

A 33,9 cm - 13<sup>3</sup>/<sub>8</sub>"  
 a 29 cm - 11<sup>1</sup>/<sub>8</sub>"  
 B 27,9 cm - 11"  
 b 25,1 cm - 9<sup>7</sup>/<sub>8</sub>"

### TRIM TILES

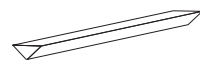

1,4x50 cm - 5<sup>5</sup>/<sub>8</sub>"x19<sup>5</sup>/<sub>8</sub>"  
 LM5C Marvel Royal Calacatta Corner 50 \*  
 LM5W Marvel Imperial White Corner 50 \*  
 LM5S Marvel Elegant Sable Corner 50 \*

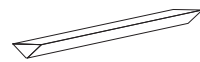

1,4x40 cm - 5<sup>5</sup>/<sub>8</sub>"x15<sup>5</sup>/<sub>4</sub>"  
 LM4C Marvel Royal Calacatta Corner 40 \*  
 LM4W Marvel Imperial White Corner 40 \*  
 LM4S Marvel Elegant Sable Corner 40 \*  
 LM4G Marvel Gris Clair Corner 40 \*  
 LM4O Marvel Absolute Brown Corner 40 \*



1,4x1,4 cm - 5<sup>5</sup>/<sub>8</sub>"x2<sup>1</sup>/<sub>8</sub>"  
 AMCY Marvel Royal Calacatta Corner A.E. \*  
 AMCX Marvel Imperial White Corner A.E. \*  
 AMCS Marvel Elegant Sable Corner A.E. \*  
 AMCR Marvel Gris Clair Corner A.E. \*  
 AMCO Marvel Absolute Brown Corner A.E. \*

\* These parts are supplied to order - I pezzi sono disponibili su ordinazione -  
 Les pièces sont disponibles sur commande - Die Teile sind auf Bestellung lieferbar -  
 Las piezas se hacen por encargo - Изготавливаются на заказ

<sup>(1)</sup> Contains gold. The use of a common mild detergent is recommended. Avoid using acidic or alkaline products, waxes, steel wool or abrasives. - Parti in oro. Si consiglia l'utilizzo di un comune detergente neutro. Evitare l'utilizzo di prodotti acidi o alcalini, ceranti, pagliette di metallo o abrasive. - Parties dorées. Nous vous conseillons d'utiliser des détergents neutres courants. Éviter l'utilisation de cires et de produits acides ou alcalins, ainsi que les pailles métalliques ou abrasives. - Teile aus Gold. Es empfiehlt sich, ein haushaltsübliches, neutrales Reinigungsmittel zu verwenden. Saure oder alkalische Produkte, Wachs sowie Metallwolle- bzw. Scheuerschwämme sind zu vermeiden. - Partes doradas. Recomendamos utilizar un detergente neutro común. Hay que evitar el uso de productos ácidos o alcalinos, ceras y estropajos de metal o abrasivos. - Золотые детали. Рекомендуется чистить обычным нейтральным моющим средством. Не рекомендуется использовать кислотные, щелочные, восковые средства, а также металлические мочалки.

INDEX



A COMPLETE  
 PRODUCT  
 SYSTEM



PRODUCT  
 FINDER



SURFACE  
 RANGE



COMPANY



COLLECTIONS



3D WALL  
 CONCRETE & RESIN LOOK  
 METAL LOOK  
 MARBLE LOOK  
 STONE LOOK  
 WOOD LOOK

LARGE SIZES



SLABS FOR  
 COUNTERTOPS  
 & FURNITURE



SINKS &  
 BATHROOM  
 FURNISHING



FACADES



TECHNICAL  
 SPECIFICATIONS



# Marvel Edge

## Wall Tiles

### DECOR RANGE



8EGD Marvel Royal Calacatta Gold Vein 1 <sup>(1) (2)</sup>  
40x80 - 15<sup>3</sup>/<sub>4</sub>"x31<sup>1</sup>/<sub>2</sub>"



8EGE Marvel Royal Calacatta Gold Vein 2 <sup>(1) (2)</sup>  
40x80 - 15<sup>3</sup>/<sub>4</sub>"x31<sup>1</sup>/<sub>2</sub>"



8EW1 Marvel Imperial White Gold Vein 1 <sup>(1) (2)</sup>  
40x80 - 15<sup>3</sup>/<sub>4</sub>"x31<sup>1</sup>/<sub>2</sub>"



8EW2 Marvel Imperial White Gold Vein 2 <sup>(1) (2)</sup>  
40x80 - 15<sup>3</sup>/<sub>4</sub>"x31<sup>1</sup>/<sub>2</sub>"

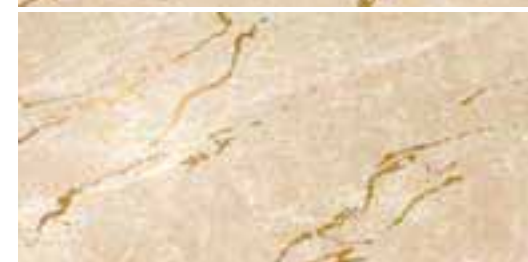

8ES1 Marvel Elegant Sable Gold Vein 1 <sup>(1) (2)</sup>  
40x80 - 15<sup>3</sup>/<sub>4</sub>"x31<sup>1</sup>/<sub>2</sub>"



8ES2 Marvel Elegant Sable Gold Vein 2 <sup>(1) (2)</sup>  
40x80 - 15<sup>3</sup>/<sub>4</sub>"x31<sup>1</sup>/<sub>2</sub>"

<sup>(1)</sup> Contains gold. The use of a common mild detergent is recommended. Avoid using acidic or alkaline products, waxes, steel wool, or abrasives. - Parti in oro. Si consiglia l'utilizzo di un comune detergente neutro. Evitare l'utilizzo di prodotti acidi o alcalini, ceranti, pagliette di metallo o abrasive. - Parties dorées. Nous vous conseillons d'utiliser des détergents neutres courants. Éviter l'utilisation de cires et de produits acides ou alcalins, ainsi que les pâilles métalliques ou abrasives - Teile aus Gold. Es empfiehlt sich, ein haushaltsübliches, neutrales Reinigungsmittel zu verwenden. Saure oder alkalische Produkte, Wachs sowie Metallwolle- bzw. Scheuerschwämme sind zu vermeiden. - Partes doradas. Recomendamos utilizar un detergente neutro común. Hay que evitar el uso de productos ácidos o alcalinos, ceras y estropajos de metal o abrasivos. - Золотые детали. Рекомендуется чистить обычным нейтральным моющим средством. Не рекомендуется использовать кислотные, щелочные, восковые средства, а также металлические мочалки.

<sup>(2)</sup> The gold vein decoration consists of four different patterns of golden veins contained in two boxes of two pieces each: gold vein 1 and gold vein 2. - Il decoro gold vein è composto da quattro diversi pattern di vene dorate, contenuti in due scatole da 2 pezzi ciascuna: gold vein 1 e gold vein 2. - Les décors Gold Vein sont composés de quatre différents motifs de veines dorées et sont contenus dans deux boîtes de 2 pièces chacune : Gold Vein 1 et Gold Vein 2. - Das Dekor Gold Vein setzt sich aus vier verschiedenen Motiven mit vergoldeten Aderungen zusammen, die in zwei Schachteln mit je 2 Fliesen verpackt sind: Gold Vein 1 und Gold Vein 2. - La decoración Gold Vein consta de cuatro pattern diferentes de vetas doradas, contenidas en dos cajas de 2 piezas cada una: Gold Vein 1 y Gold Vein 2. - Декор Gold Vein включает четыре разных рисунка золотистых прожилок, упакованных в две коробки по 2 штуки в каждой: Gold Vein 1 и Gold Vein 2.



© Ceramiche Atlas Concorde



© Ceramiche Atlas Concorde



© Ceramiche Atlas Concorde

INDEX



A COMPLETE PRODUCT SYSTEM



PRODUCT FINDER



SURFACE RANGE



COMPANY



COLLECTIONS



3D WALL  
CONCRETE & RESIN LOOK  
METAL LOOK  
MARBLE LOOK  
STONE LOOK  
WOOD LOOK

LARGE SIZES



SLABS FOR COUNTERTOPS & FURNITURE



SINKS & BATHROOM FURNISHING



FACADES



TECHNICAL SPECIFICATIONS



# Marvel Gala

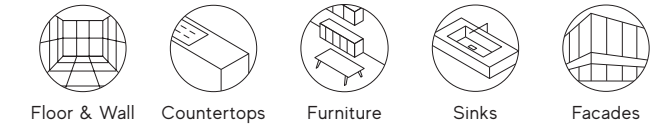
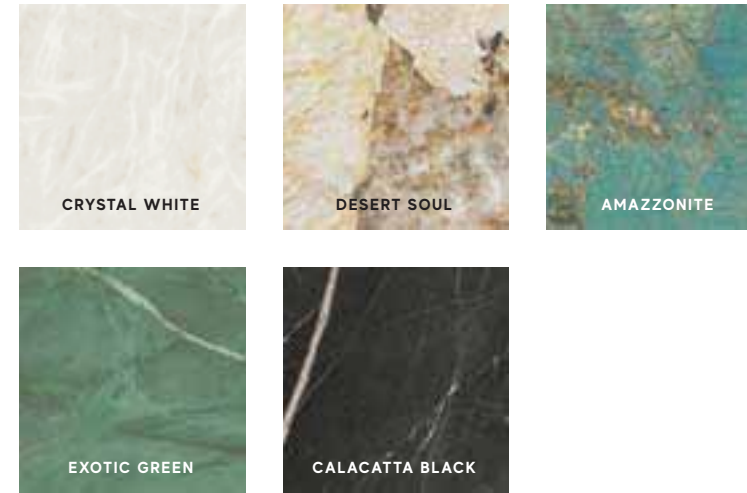

## Porcelain Tiles RECTIFIED MONOCALIBER

Sizes	Thickness	Surface finish
120x278 cm - 47 <sup>1</sup> / <sub>4</sub> "x109 <sup>1</sup> / <sub>2</sub> "	± 6 mm	Polished
120x120 cm - 47 <sup>1</sup> / <sub>4</sub> "x47 <sup>1</sup> / <sub>4</sub> "	± 9 mm	Polished
60x120 cm - 23 <sup>3</sup> / <sub>8</sub> "x47 <sup>1</sup> / <sub>4</sub> "	± 9 mm	Polished

LARGE SIZES p. 356

### atlasPLAN

#### SLABS FOR COUNTERTOPS & FURNITURE

162x324 cm - 63 <sup>3</sup> / <sub>4</sub> "x127 <sup>1</sup> / <sub>2</sub> " NON-RECTIFIED	± 6-12-20 mm	Polished   Silk
159x324 cm - 62 <sup>5</sup> / <sub>8</sub> "x127 <sup>1</sup> / <sub>2</sub> " NON-RECTIFIED	± 20 mm	Polished



INDEX



A COMPLETE PRODUCT SYSTEM >

PRODUCT FINDER >

SURFACE RANGE >

COMPANY >

COLLECTIONS >

3D WALL  
CONCRETE & RESIN LOOK  
METAL LOOK  
MARBLE LOOK  
STONE LOOK  
WOOD LOOK

LARGE SIZES >

SLABS FOR COUNTERTOPS & FURNITURE >

SINKS & BATHROOM FURNISHING >

FACADES >

TECHNICAL SPECIFICATIONS >



# Marvel Gala

## Porcelain Tiles

### POLISHED SURFACE <sup>(1)</sup>



± 6 mm

120x278 cm - 47 1/4" x 109 1/2"

- AFXU Marvel Exotic Green Polished
- AFXV Marvel Desert Soul Polished
- AFXW Marvel Crystal White Polished
- AFXX Marvel Amazonite Polished
- AFXY Marvel Calacatta Black Polished



± 9 mm

120x120 cm - 47 1/4" x 47 1/4"

- ABKA Marvel Exotic Green Polished
- AFXM Marvel Desert Soul Polished
- AFXN Marvel Crystal White Polished
- ABKB Marvel Amazonite Polished
- AFXO Marvel Calacatta Black Polished



± 9 mm

60x120 cm - 23 5/8" x 47 1/4"

- AFXP Marvel Exotic Green Polished
- AFXQ Marvel Desert Soul Polished
- AFXR Marvel Crystal White Polished
- AFXS Marvel Amazonite Polished
- AFXT Marvel Calacatta Black Polished



Polished ± 6 mm  
Polished ± 9 mm



V3 Moderate  
Variation



Floor  
& Wall

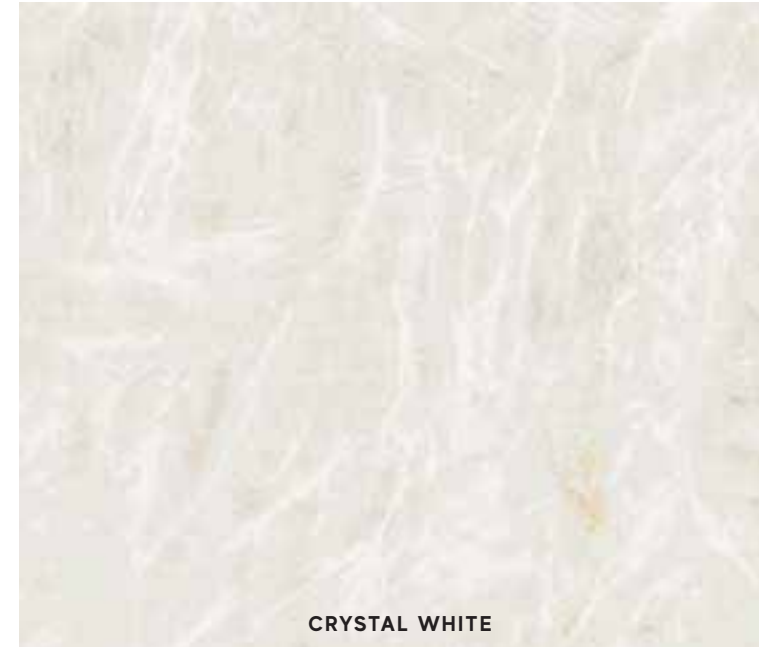

CRYSTAL WHITE



DESERT SOUL



AMAZZONITE



EXOTIC GREEN



CALACATTA BLACK

<sup>(1)</sup> The glossy polished finish is suitable for residential or low-traffic commercial floors, where no anti-slip performance is required, and for walls. The polished glossy surface finish, surprisingly brilliant and bright, features slight irregularities typical of natural marble. The extraordinary brilliance and the easy cleaning of the surface are the result of in-depth research aimed at guaranteeing its durability over time. If the product is in direct contact with the outdoors, provide devices for absorbing moisture and dirt to prevent scratches. - La finitura lappata lucida è indicata per pavimenti residenziali o commerciali poco sollecitati, laddove non siano richieste prestazioni antiscivolo, e per rivestimenti. La finitura lappata lucida offre una superficie sorprendentemente brillante e specchiante, con lievi irregolarità tipiche dei marmi naturali. La straordinaria lucentezza e l'elevata pulibilità della superficie sono frutto di studi approfonditi e accurate ricerche tecniche volte a garantirne la persistenza nel tempo. Se il prodotto è a diretto contatto con l'esterno, prevedere dei dispositivi di assorbimento dell'umidità e della sporcizia per prevenire la formazione di graffi.

### COMPLETE YOUR PROJECT



Countertops  
P. 402  
162x324 cm  
NON-RECTIFIED



Furniture  
P. 356



Sinks  
P. 412

INDEX



A COMPLETE  
PRODUCT  
SYSTEM >

PRODUCT  
FINDER >

SURFACE  
RANGE >

COMPANY >

COLLECTIONS >

- 3D WALL
- CONCRETE & RESIN LOOK
- METAL LOOK
- MARBLE LOOK
- STONE LOOK
- WOOD LOOK

LARGE SIZES >

SLABS FOR  
COUNTERTOPS  
& FURNITURE >

SINKS &  
BATHROOM  
FURNISHING >

FACADES >

TECHNICAL  
SPECIFICATIONS >

# Marvel Gems



© Ceramiche Atlas Concorde

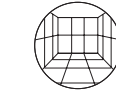

Floor & Wall

## Porcelain Tiles RECTIFIED MONOCALIBER

### MATTE SURFACE



± 9 mm

- 60x60 cm - 23<sup>3</sup>/<sub>8</sub>"x23<sup>3</sup>/<sub>8</sub>"
- ATW3 Marvel Terrazzo White
- ATW4 Marvel Terrazzo Pearl
- ATW5 Marvel Terrazzo Cream
- ATW6 Marvel Terrazzo Grey
- ATW7 Marvel Terrazzo Black

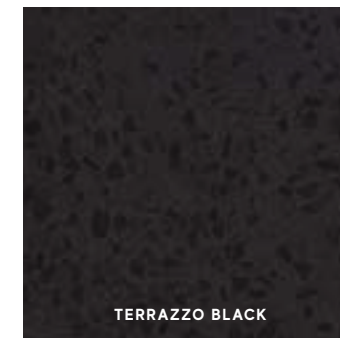
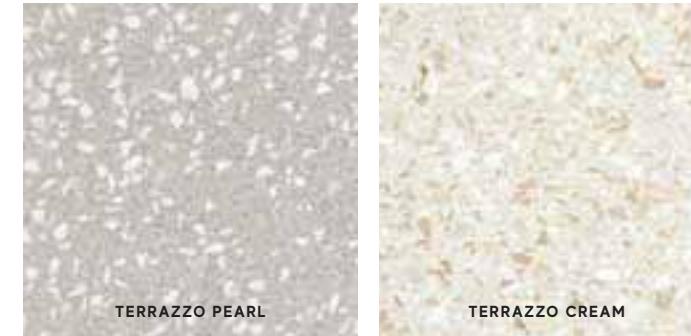
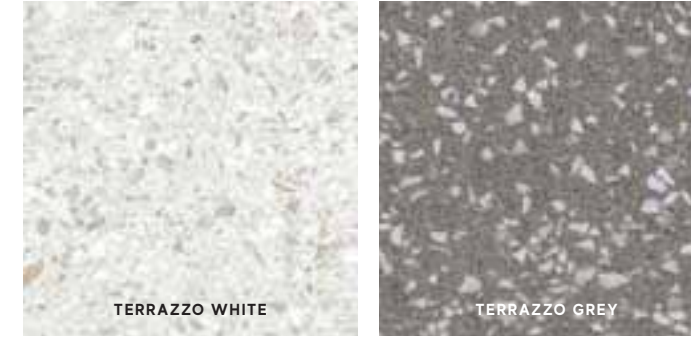

Matte ± 9 mm

R10 B Matte Sensitech (S) ± 9 mm

V2 Slight Variation

#### TRIM TILES p. 352

- Terrazzo White
- Terrazzo Pearl
- Terrazzo Cream
- Terrazzo Grey
- Terrazzo Black

- AT9M
- AT9N
- AT9O
- AT9P
- AT9Q

#### Battiscopa

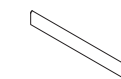

7,2x60 cm  
2<sup>7</sup>/<sub>8</sub>"x23<sup>3</sup>/<sub>8</sub>"

- Matte
- AT9M
- AT9N
- AT9O
- AT9P
- AT9Q

Digitale 4,6x60 cm  
1<sup>7</sup>/<sub>8</sub>"x23<sup>3</sup>/<sub>8</sub>"

- Matte
- AT9H
- AT9I
- AT9J
- AT9K
- AT9L

#### Gradino \*



30x60 cm  
11<sup>3</sup>/<sub>8</sub>"x23<sup>3</sup>/<sub>8</sub>"

- Matte
- AUDB
- AUDC
- AUDD
- AUDE
- AUDF

#### Scalino \*

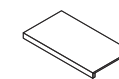

33x60 cm  
13"x23<sup>3</sup>/<sub>8</sub>"

- Matte
- AT9R
- AT9T
- AT9U
- AT9V
- AT9W

#### Scalino Ang. \*

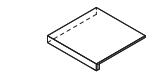

33x33 cm  
13"x13"

- Matte
- AS8Y
- AS8Z
- AS8Ø
- AS81
- AS82

\* These parts are supplied to order - I pezzi sono disponibili su ordinazione - Les pièces sont disponibles sur commande - Die Teile sind auf Bestellung lieferbar - Las piezas se hacen por encargo - Изготавливаются на заказ



INDEX



A COMPLETE  
PRODUCT  
SYSTEM >

PRODUCT  
FINDER >

SURFACE  
RANGE >

COMPANY >

COLLECTIONS >

- 3D WALL
- CONCRETE & RESIN LOOK
- METAL LOOK
- MARBLE LOOK
- STONE LOOK
- WOOD LOOK

LARGE SIZES >

SLABS FOR  
COUNTERTOPS  
& FURNITURE >

SINKS &  
BATHROOM  
FURNISHING >

FACADES >

TECHNICAL  
SPECIFICATIONS >

# Marvel Pro



© Ceramiche Atlas Concorde



© Ceramiche Atlas Concorde



© Ceramiche Atlas Concorde

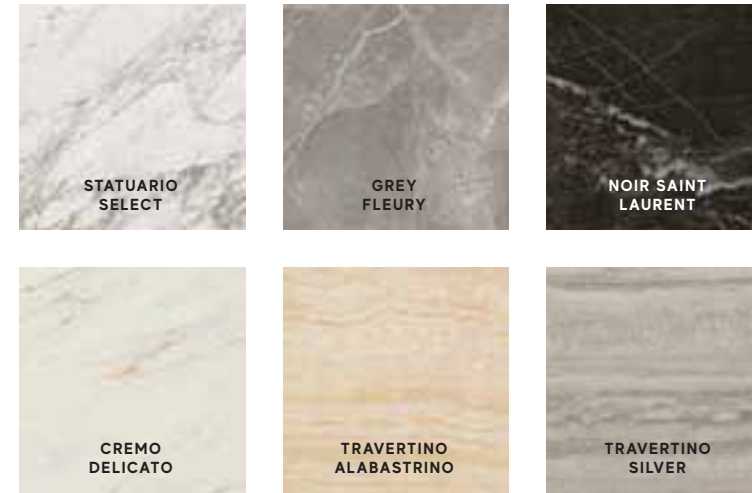

## Porcelain Tiles RECTIFIED MONOCALIBER

Sizes	Thickness	Surface finish
160x160 cm - 63"x63"	± 6 mm	Polished
120x278 cm - 47 1/4"x109 1/2"	± 6 mm	Polished   Matte <b>R9 A</b>
120x240 cm - 47 1/4"x94 1/2"	± 9 mm	Polished
120x120 cm - 47 1/4"x47 1/4"	± 9 mm	Polished   Matte <b>Sensitech R10 B</b>
60x120 cm - 23 5/8"x47 1/4"	± 9 mm	Polished   Matte <b>Sensitech R10 B</b>
75x150 cm - 29 1/2"x59"	± 9 mm	Polished
75x75 cm - 29 1/2"x29 1/2"	± 9 mm	Polished
60x60 cm - 23 5/8"x23 5/8"	± 9 mm	Polished   Matte <b>Sensitech R10 B</b>
30x60 cm - 11 7/8"x23 5/8"	± 9 mm	Polished   Matte <b>Sensitech R10 B</b>
<b>LARGE SIZES P. 356</b>		
<b>OUTDOOR AND WET AREAS</b>		
30x60 cm - 11 7/8"x23 5/8"	± 9 mm	Textured <b>R11 B</b>
<b>atlasPLAN</b>		
160x320 cm - 63"x126"	± 6 mm	Polished

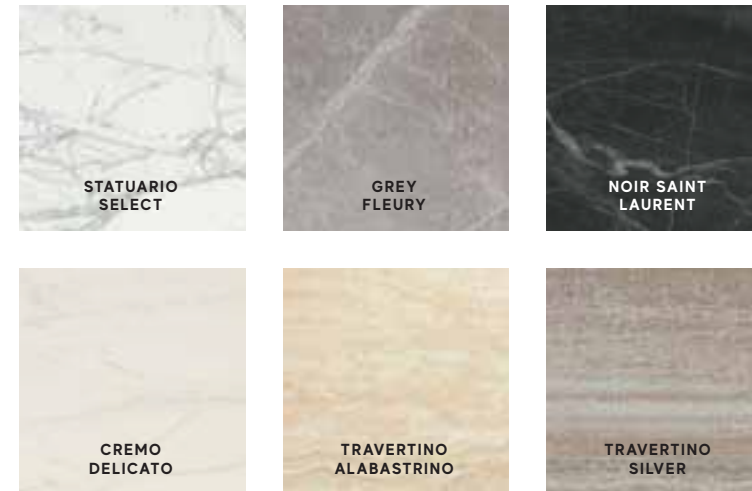

## Wall Tiles RECTIFIED MONOCALIBER

Sizes	Thickness	Surface finish
50x120 cm - 19 5/8"x47 1/4"	± 8,5 mm	Shiny
40x80 cm - 15 7/8"x31 1/2"	± 8,5 mm	Shiny
30,5x91,5 cm - 12"x36"	± 8,5 mm	Shiny
8x31,5 cm - 3 1/8"x12 3/8"	± 8,5 mm	Shiny

INDEX

A COMPLETE PRODUCT SYSTEM

PRODUCT FINDER

SURFACE RANGE

COMPANY

COLLECTIONS

- 3D WALL
- CONCRETE & RESIN LOOK
- METAL LOOK
- MARBLE LOOK
- STONE LOOK
- WOOD LOOK

LARGE SIZES

SLABS FOR COUNTERTOPS & FURNITURE

SINKS & BATHROOM FURNISHING

FACADES

TECHNICAL SPECIFICATIONS

# Marvel Pro

## Porcelain Tiles

### POLISHED SURFACE <sup>(1)</sup>



± 6 mm  
**160x320 cm** - 63"x126"  
 AO5W Marvel Crema Delicato Polished



± 6 mm  
**160x160 cm** - 63"x63"  
 AO5Z Marvel Crema Delicato Polished



± 6 mm  
**120x278 cm** - 47 1/4"x109 1/2"  
 AØBN Marvel Statuario Select Polished  
 AØBO Marvel Crema Delicato Polished  
 A2RX Marvel Grey Fleury Polished



± 9 mm  
**120x240 cm** - 47 1/4"x94 1/2"  
 AY2P Marvel Statuario Select Polished  
 AY2Q Marvel Crema Delicato Polished



± 9 mm  
**120x120 cm** - 47 1/4"x47 1/4"  
 AY2T Marvel Statuario Select Polished  
 AY2U Marvel Crema Delicato Polished  
 A21O Marvel Grey Fleury Polished



± 9 mm  
**60x120 cm** - 23 5/8"x47 1/4"  
 A21N Marvel Crema Delicato Polished  
 A21M Marvel Grey Fleury Polished



± 9 mm  
**60x60 cm** - 23 5/8"x23 5/8"  
 ADUM Marvel Statuario Select Polished  
 ADUK Marvel Crema Delicato Polished  
 ADUO Marvel Grey Fleury Polished  
 ADUP Marvel Noir St. Laurent Polished  
 ADUL Marvel Travertino Alabastrino Polished  
 ADUN Marvel Travertino Silver Polished



± 9 mm  
**30x60 cm** - 11 3/4"x23 5/8"  
 DØ32 Marvel Statuario Select Polished  
 DØ3Ø Marvel Crema Delicato Polished  
 DØ34 Marvel Grey Fleury Polished  
 DØ35 Marvel Noir St. Laurent Polished  
 DØ31 Marvel Travertino Alabastrino Polished  
 DØ33 Marvel Travertino Silver Polished



± 9 mm  
**75x150 cm** - 29 1/2"x59"  
 A7F4 Marvel Statuario Select Polished  
 A7F6 Marvel Crema Delicato Polished  
 A7F8 Marvel Grey Fleury Polished  
 A7F9 Marvel Noir St. Laurent Polished  
 A7F5 Marvel Travertino Alabastrino Polished  
 A7F7 Marvel Travertino Silver Polished



± 9 mm  
**75x75 cm** - 29 1/2"x29 1/2"  
 AD4U Marvel Statuario Select Polished  
 AD4W Marvel Crema Delicato Polished  
 AD4Y Marvel Grey Fleury Polished  
 AD4Z Marvel Noir St. Laurent Polished  
 AD4V Marvel Travertino Alabastrino Polished  
 AD4X Marvel Travertino Silver Polished

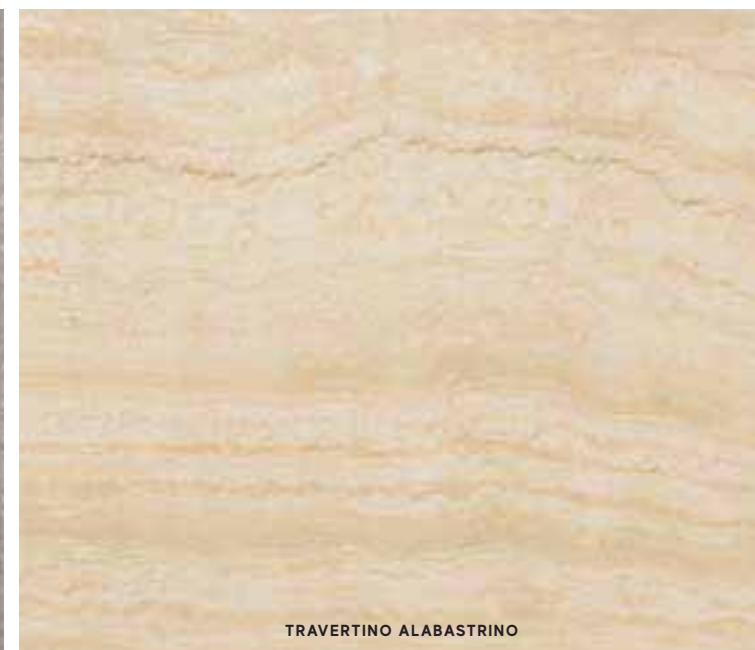
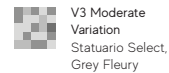

<sup>(1)</sup> The glossy polished finish is suitable for residential or low-traffic commercial floors, where no anti-slip performance is required, and for walls. The polished glossy surface finish, surprisingly brilliant and bright, features slight irregularities typical of natural marble. The extraordinary brilliance and the easy cleaning of the surface are the result of in-depth research aimed at guaranteeing its durability over time. If the product is in direct contact with the outdoors, provide devices for absorbing moisture and dirt to prevent scratches. - La finitura lappata lucida è indicata per pavimenti residenziali o commerciali poco sollecitati, laddove non siano richieste prestazioni antiscivolo, e per rivestimenti. La finitura lappata lucida offre una superficie sorprendentemente brillante e specchiante, con lievi irregolarità tipiche dei marmi naturali. La straordinaria lucentezza e l'elevata pulibilità della superficie sono frutto di studi approfonditi e accurate ricerche tecniche volte a garantirne la persistenza nel tempo. Se il prodotto è a diretto contatto con l'esterno, prevedere dei dispositivi di assorbimento dell'umidità e della sporcizia per prevenire la formazione di graffi.

### COMPLETE YOUR PROJECT

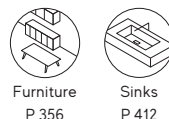

INDEX



A COMPLETE PRODUCT SYSTEM



PRODUCT FINDER



SURFACE RANGE



COMPANY



COLLECTIONS



- 3D WALL
- CONCRETE & RESIN LOOK
- METAL LOOK
- MARBLE LOOK
- STONE LOOK
- WOOD LOOK

LARGE SIZES



SLABS FOR COUNTERTOPS & FURNITURE



SINKS & BATHROOM FURNISHING



FACADES



TECHNICAL SPECIFICATIONS



# Marvel Pro

## Porcelain Tiles



Matte ± 6 mm



Matte ± 9 mm  
Textured ± 9 mm



R9 A Matte ± 6 mm  
R10 B Matte Sensitech (S) ± 9 mm  
R11 B Textured ± 9 mm



V2 Slight Variation  
Cremo Delicato,  
Travertino Alabastrino,  
Travertino Silver,  
Noir St. Laurent



V3 Moderate Variation  
Statuario Select,  
Grey Fleury



### MATTE SURFACE



± 6 mm

120x278 cm - 47 1/4" x 109 1/2"

A2RU Marvel Cremo Delicato

A2RT Marvel Grey Fleury

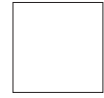

± 9 mm

120x120 cm - 47 1/4" x 47 1/4"

A2Ø6 Marvel Cremo Delicato

A2Ø5 Marvel Grey Fleury

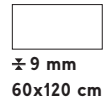

± 9 mm

60x120 cm - 23 5/8" x 47 1/4"

A21G Marvel Cremo Delicato

A21F Marvel Grey Fleury

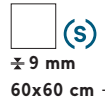

± 9 mm

60x60 cm - 23 5/8" x 23 5/8"

AVGC Marvel Statuario Select

AVGD Marvel Cremo Delicato

AVGF Marvel Grey Fleury

AVGG Marvel Noir St. Laurent

AVA7 Marvel Travertino Alabastrino

AVGE Marvel Travertino Silver



± 9 mm

30x60 cm - 11 3/4" x 23 5/8"

D1Ø1 Marvel Statuario Select

D1Ø3 Marvel Cremo Delicato

D1Ø5 Marvel Grey Fleury

D1Ø6 Marvel Noir St. Laurent

D1Ø2 Marvel Travertino Alabastrino

D1Ø4 Marvel Travertino Silver



### TEXTURED SURFACE



± 9 mm

30x60 cm - 11 3/4" x 23 5/8"

D1Ø9 Marvel Statuario Select Strutturato

D1Ø7 Marvel Cremo Delicato Strutturato

D1Ø8 Marvel Grey Fleury Strutturato

### TRIM TILES

p. 352

#### Battiscopa

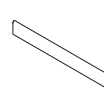

7,2x60 cm  
2 7/8" x 23 5/8"

Matte Polished

#### Gradino \*



30x60 cm  
11 3/4" x 23 5/8"

Matte

#### Scalino \*



33x60 cm  
13" x 23 5/8"

Matte

#### Scalino Ang.\*

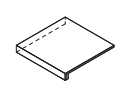

33x33 cm  
13" x 13"

Matte

DX

ADXU

ADXW

SX

ADXV

ADXX

#### Battiscopa Sag. Scala \*



7,2x30 cm  
2 7/8" x 11 3/4"

Matte

DX

ADXØ

ADX4

ADX2

ADX6

ADX8

SX

ADX1

ADX5

ADX3

ADX7

ADX9

#### Elemento L Str. \*

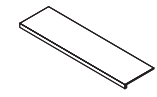

15x60 H. 4 cm  
5 7/8" x 23 5/8" H. 1 5/8"

Matte

-

-

ADYD

ADYE

ADYF

-

Travertino Alabastrino

ADV4

ADWA

ADW6

ADX1

ADXQ

ADXØ

-

Travertino Silver

ADV6

ADWC

ADW8

ADXK

ADX4

ADX4

-

Statuario Select

ADV3

ADV9

ADW5

ADXH

ADXQ

ADX5

ADYD

Cremo Delicato

ADV5

ADWB

ADW7

ADXJ

ADXR

ADX2

ADYE

Grey Fleury

ADV7

ADWD

ADW9

ADXL

ADXS

ADX6

ADYF

Noir St. Laurent

ADV8

ADWE

ADXA

ADXM

ADXT

ADX8

-

\* These parts are supplied to order - I pezzi sono disponibili su ordinazione - Les pièces sont disponibles sur commande - Die Teile sind auf Bestellung lieferbar - Las piezas se hacen por encargo - Изготавливаются на заказ

### COMPLETE YOUR PROJECT



Furniture  
P.356



Sinks  
P.412



Facades  
P.436



STATUARIO SELECT



CREMO DELICATO

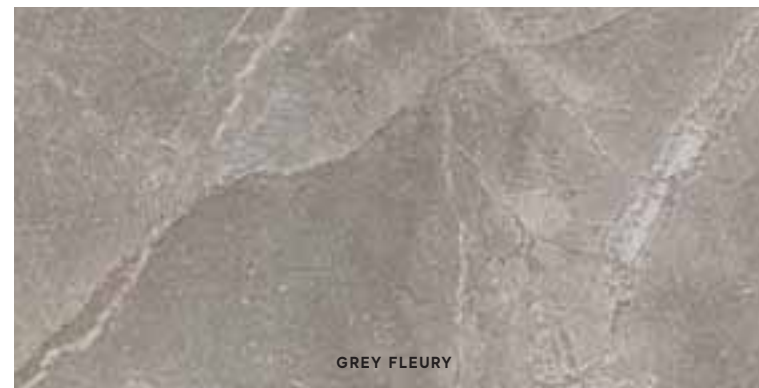

GREY FLEURY

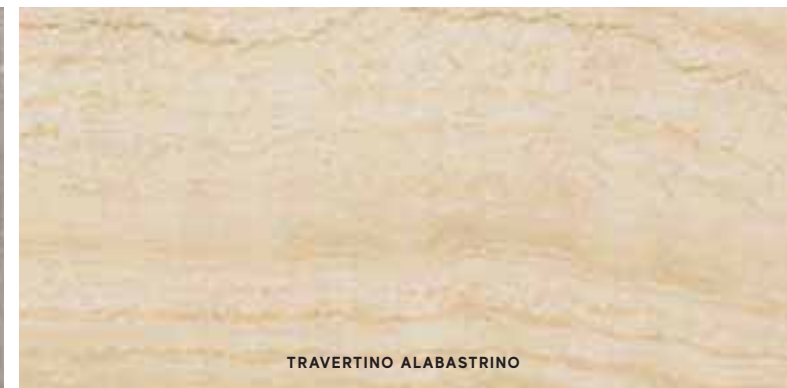

TRAVERTINO ALABASTRINO



NOIR SAINT LAURENT



TRAVERTINO SILVER



STATUARIO SELECT TEXTURED



CREMO DELICATO TEXTURED



GREY FLEURY TEXTURED



# Marvel Pro

## Porcelain Tiles

### DECOR RANGE



ADP6 Marvel Statuario Select Mosaico 3D<sup>(1)</sup>  
30x30 - 1 1/4" x 1 1/4"



ADQA Marvel Grey Fleury Mosaico 3D<sup>(1)</sup>  
30x30 - 1 1/4" x 1 1/4"

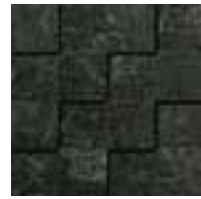

ADQB Marvel Noir St. Laurent Mosaico 3D<sup>(1)</sup>  
30x30 - 1 1/4" x 1 1/4"



ADP8 Marvel Crema Delicato Mosaico 3D<sup>(1)</sup>  
30x30 - 1 1/4" x 1 1/4"



ADP7 Marvel Travertino Alabastrino Mosaico 3D<sup>(1)</sup>  
30x30 - 1 1/4" x 1 1/4"



ADP9 Marvel Travertino Silver Mosaico 3D<sup>(1)</sup>  
30x30 - 1 1/4" x 1 1/4"

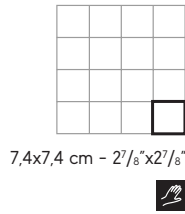

7,4x7,4 cm - 2 7/8" x 2 7/8"



ADQI Marvel Statuario Select Mosaico Matte  
30x30 - 1 1/4" x 1 1/4"



ADQM Marvel Grey Fleury Mosaico Matte  
30x30 - 1 1/4" x 1 1/4"



ADQN Marvel Noir St. Laurent Mosaico Matte  
30x30 - 1 1/4" x 1 1/4"



ADQK Marvel Crema Delicato Mosaico Matte  
30x30 - 1 1/4" x 1 1/4"



ADQJ Marvel Travertino Alabastrino Mosaico Matte  
30x30 - 1 1/4" x 1 1/4"



ADQL Marvel Travertino Silver Mosaico Matte  
30x30 - 1 1/4" x 1 1/4"

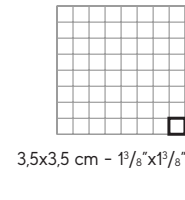

3,5x3,5 cm - 1 1/8" x 1 1/8"



ADQC Marvel Statuario Select Mosaico Polished  
30x30 - 1 1/4" x 1 1/4"

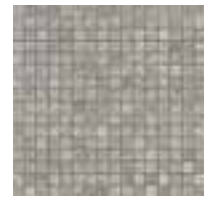

ADQG Marvel Grey Fleury Mosaico Polished  
30x30 - 1 1/4" x 1 1/4"

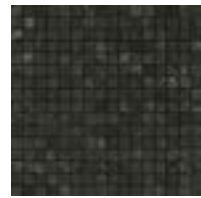

ADQH Marvel Noir St. Laurent Mosaico Polished  
30x30 - 1 1/4" x 1 1/4"



ADQE Marvel Crema Delicato Mosaico Polished  
30x30 - 1 1/4" x 1 1/4"



ADQD Marvel Travertino Alabastrino Mosaico Polished  
30x30 - 1 1/4" x 1 1/4"

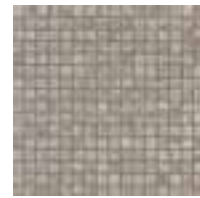

ADQF Marvel Travertino Silver Mosaico Polished  
30x30 - 1 1/4" x 1 1/4"

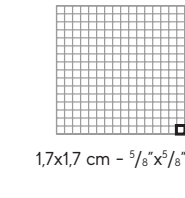

1,7x1,7 cm - 5/8" x 5/8"



ADVK Marvel Statuario Select Mosaico Esagono Polished  
30x35 - 1 1/4" x 1 3/4"



ADVO Marvel Grey Fleury Mosaico Esagono Polished  
30x35 - 1 1/4" x 1 3/4"



ADVP Marvel Noir St. Laurent Mosaico Esagono Polished  
30x35 - 1 1/4" x 1 3/4"



ADVQ Marvel Mosaico Esagono Multicolor Cold  
30x35 - 1 1/4" x 1 3/4"

Statuario Select + Grey Fleury + Noir St. Laurent

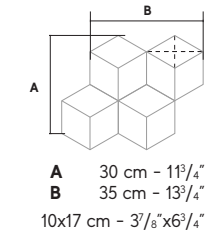

A 30 cm - 11 3/4"  
B 35 cm - 13 3/4"  
10x17 cm - 3 7/8" x 6 1/4"



ADVM Marvel Crema Delicato Mosaico Esagono Polished  
30x35 - 1 1/4" x 1 3/4"



ADVL Marvel Travertino Alabastrino Mosaico Esagono Polished  
30x35 - 1 1/4" x 1 3/4"



ADVN Marvel Travertino Silver Mosaico Esagono Polished  
30x35 - 1 1/4" x 1 3/4"



ADVR Marvel Mosaico Esagono Multicolor Warm  
30x35 - 1 1/4" x 1 3/4"

Crema Delicato + Travertino Alabastrino + Noir St. Laurent



ADVA Marvel Mosaico Honeycomb Cold Polished  
30x49 - 1 1/4" x 1 9/4"

Statuario Select + Noir St. Laurent



ADVB Marvel Mosaico Honeycomb Warm Polished  
30x49 - 1 1/4" x 1 9/4"

Crema Delicato + Noir St. Laurent

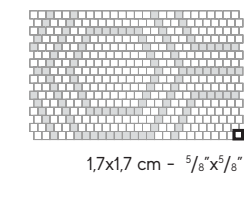

1,7x1,7 cm - 5/8" x 5/8"



ADU9 Marvel Mosaico Circle Polished  
30x30 - 1 1/4" x 1 1/4"

Crema Delicato + Noir St. Laurent

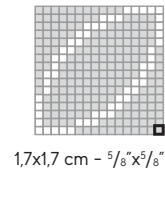

1,7x1,7 cm - 5/8" x 5/8"



ADRJ Marvel Noir/Crema Greca Mosaico  
18,5x30 - 7 1/4" x 1 1/4"

Crema Delicato + Noir St. Laurent



ADRI Marvel Noir/Crema Angolo Mosaico  
18,5x18,5 - 7 1/4" x 7 1/4"

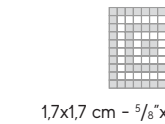

1,7x1,7 cm - 5/8" x 5/8"

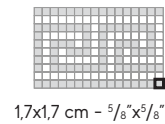

1,7x1,7 cm - 5/8" x 5/8"

<sup>(1)</sup> Multi-thickness mosaic, close joint installation without grouting - Mosaico multispessore, posa senza stuccatura a giunto unito - Mosaïque multi-épaisseur, pose sans mastic avec joint nul - Mosaik mit verschiedenen Stärken, fugenlose Verlegung ohne Mörtel - Mosaico multiespesor, colocación sin mástique y sin juntas - Мозаика разной толщины, укладка встык без затирки швов

The decoration can only be laid on the wall - Il decoro si può posare solo a rivestimento - Décor uniquement mural - Das Dekor kann nur an der Wand verlegt werden - La decoración se puede colocar únicamente en paredes - Декор может быть уложен только на стену.

INDEX



A COMPLETE PRODUCT SYSTEM



PRODUCT FINDER



SURFACE RANGE



COMPANY



COLLECTIONS



3D WALL  
CONCRETE & RESIN LOOK  
METAL LOOK  
MARBLE LOOK  
STONE LOOK  
WOOD LOOK

LARGE SIZES



SLABS FOR COUNTERTOPS & FURNITURE



SINKS & BATHROOM FURNISHING



FACADES



TECHNICAL SPECIFICATIONS



# Marvel Pro

## Porcelain Tiles

### DECOR RANGE



AD5F Marvel Statuario Select Macchia Aperta Lapp A  
75x150 - 29 1/2"x59"<sup>(1)</sup>



AD5G Marvel Statuario Select Macchia Aperta Lapp B  
75x150 - 29 1/2"x59"<sup>(2)</sup>



AD5H Marvel Grey Fleury Macchia Aperta Lapp A  
75x150 - 29 1/2"x59"<sup>(2)</sup>



AD5I Marvel Grey Fleury Macchia Aperta Lapp B  
75x150 - 29 1/2"x59"<sup>(2)</sup>

In order to obtain a symmetrical open book installation pattern as reported in the charts below, it is necessary to lay an equal number of tiles of type A and B - Per ottenere la posa simmetrica a macchia aperta riportata negli schemi di posa sottostanti occorre posare un numero uguale di piastrelle di tipo A e di tipo B - Pour obtenir la pose symétrique à livre ouvert indiquée dans les schémas de pose ci-dessous, il est nécessaire de poser une quantité identique de carreaux de type A et de type B - Für die symmetrische bildfurnierte Verlegung, wie im Verlegeschema dargestellt, muss man die gleiche Anzahl von Fliesen vom Typ A und Typ B verlegen - Para obtener la colocación a libro abierto mostrada en los esquemas de colocación de abajo hay que colocar el mismo número de baldosas de tipo A y de tipo B - Для получения симметричного зеркального рисунка укладки, приведенного на схемах ниже, необходимо уложить одинаковое число плиток типа А и типа В

In order to obtain a symmetrical open book installation pattern as reported in the charts below, it is necessary to lay an equal number of tiles of type A and B - Per ottenere la posa simmetrica a macchia aperta riportata negli schemi di posa sottostanti occorre posare un numero uguale di piastrelle di tipo A e di tipo B - Pour obtenir la pose symétrique à livre ouvert indiquée dans les schémas de pose ci-dessous, il est nécessaire de poser une quantité identique de carreaux de type A et de type B - Für die symmetrische bildfurnierte Verlegung, wie im Verlegeschema dargestellt, muss man die gleiche Anzahl von Fliesen vom Typ A und Typ B verlegen - Para obtener la colocación a libro abierto mostrada en los esquemas de colocación de abajo hay que colocar el mismo número de baldosas de tipo A y de tipo B - Для получения симметричного зеркального рисунка укладки, приведенного на схемах ниже, необходимо уложить одинаковое число плиток типа А и типа В

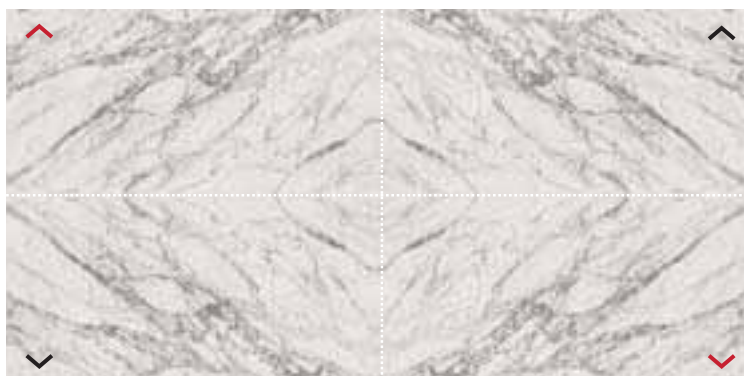

Layout 1<sup>(1)</sup> <sup>(2)</sup>

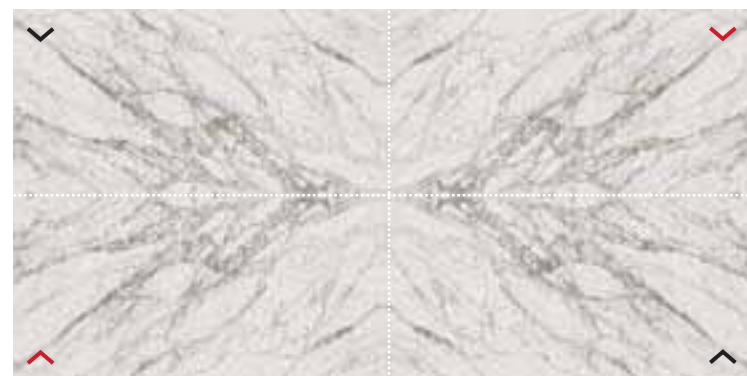

Layout 2<sup>(1)</sup> <sup>(2)</sup>



Layout 3<sup>(1)</sup> <sup>(2)</sup>

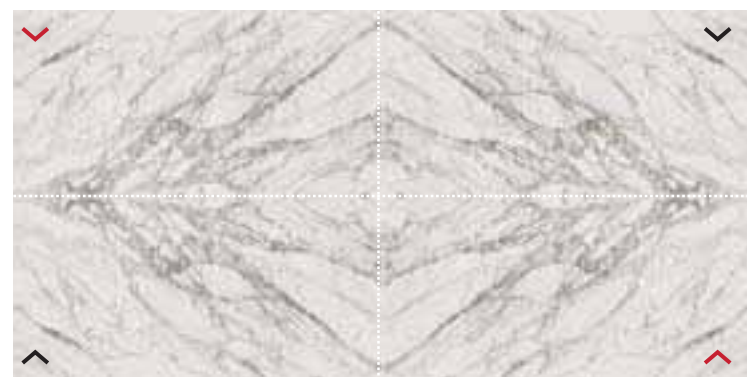

Layout 4<sup>(1)</sup>



Layout 1<sup>(1)</sup> <sup>(2)</sup>

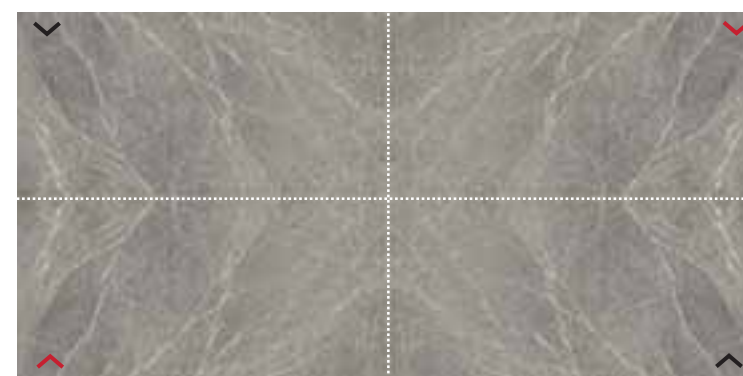

Layout 2<sup>(1)</sup> <sup>(2)</sup>

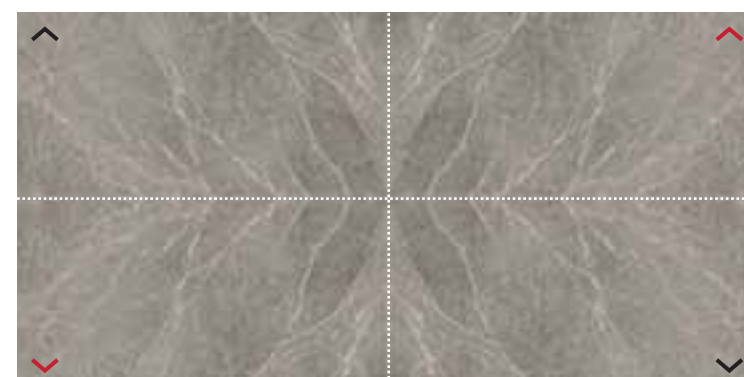

Layout 3<sup>(1)</sup> <sup>(2)</sup>

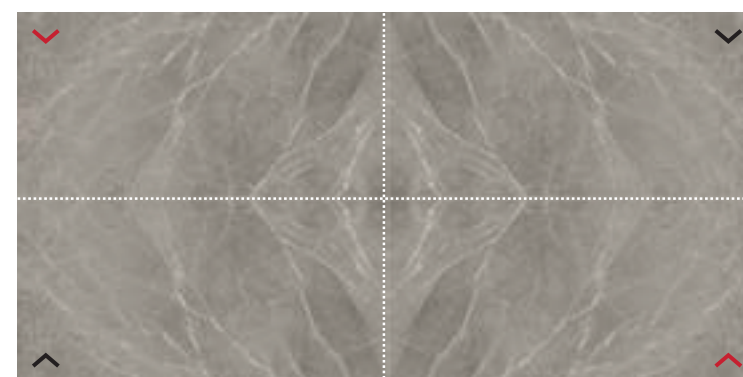

Layout 4<sup>(1)</sup>

<sup>(1)</sup>The miniatures of the multiformato module are not in proportion. - I minimali nel modulo multiformato non sono in proporzione. - Les illustrations à échelle réduite dans le Module - Multiformato ne sont pas proportionnelles.

Die Abbildungen im Modul Multiformato sind nicht verhältnismäßig. - Los miniaturas en el Módulo Multiformato no están en proporción. - Изображения Multiformato модуля не соблюдают пропорций.

<sup>(2)</sup>Minor misalignments in the continuity of the veins between different graphics is normal for this type of product. - Eventuali piccoli disallineamenti nella continuità delle venature tra grafiche diverse sono una caratteristica intrinseca di questa tipologia di prodotto. - Les éventuels petits désalignements de la continuité des veines entre différents graphismes sont une caractéristique intrinsèque de cette typologie de produit. - Eventuelle kleine Versätze im Verlauf der Äderungen zwischen unterschiedlichen Grafiken sind charakteristisch für dieses Produkt. - Cualquier pequeño desalineado en la continuidad de las vetas entre diferentes gráficos es una característica intrínseca de este tipo de productos. - Возможные небольшие смещения рисунка прожилок на стыке плит являются характеристикой данного вида изделий.

# Marvel Pro

## Wall Tiles

### SHINY SURFACE



± 8,5 mm

50x120 cm - 19<sup>5</sup>/<sub>8</sub>"x47<sup>1</sup>/<sub>4</sub>"

A4SW Marvel Statuario Select

A4SU Marvel Crema Delicato

A4SV Marvel Noir St. Laurent

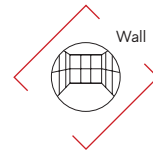

± 8,5 mm

40x80 cm - 15<sup>7</sup>/<sub>8</sub>"x31<sup>1</sup>/<sub>2</sub>"

9M4R Marvel Statuario Select

9M4E Marvel Crema Delicato

9M4F Marvel Grey Fleury

9M4L Marvel Travertino Alabastrino

9M4O Marvel Noir St. Laurent

9M4Q Marvel Travertino Silver



± 8,5 mm

30,5x91,5 cm - 12"x36"

9M3S Marvel Statuario Select

9M3C Marvel Crema Delicato

9M3G Marvel Grey Fleury

9M3T Marvel Travertino Alabastrino

9M3N Marvel Noir St. Laurent

9M3V Marvel Travertino Silver

± 8,5 mm

8x31,5 cm - 3<sup>1</sup>/<sub>8</sub>"x12<sup>3</sup>/<sub>8</sub>"

LMKT Statuario Select Brick

V2 Slight Variation  
Crema Delicato, Travertino Alabastrino,  
Travertino Silver, Noir St. Laurent

V3 Moderate Variation  
Statuario Select,  
Grey Fleury



STATUARIO SELECT

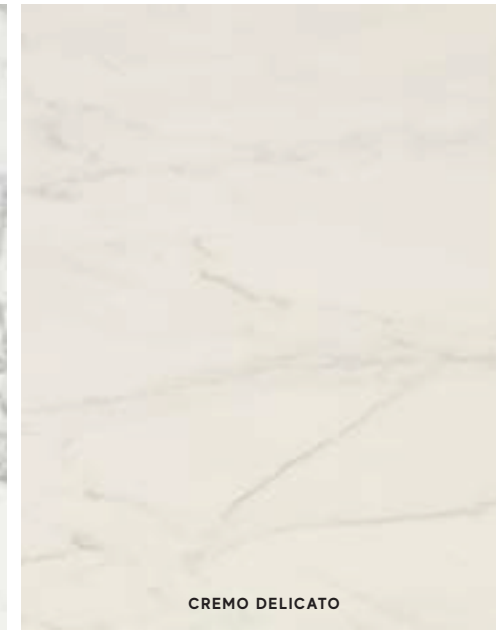

CREMA DELICATO



GREY FLEURY



TRAVERTINO ALABASTRINO

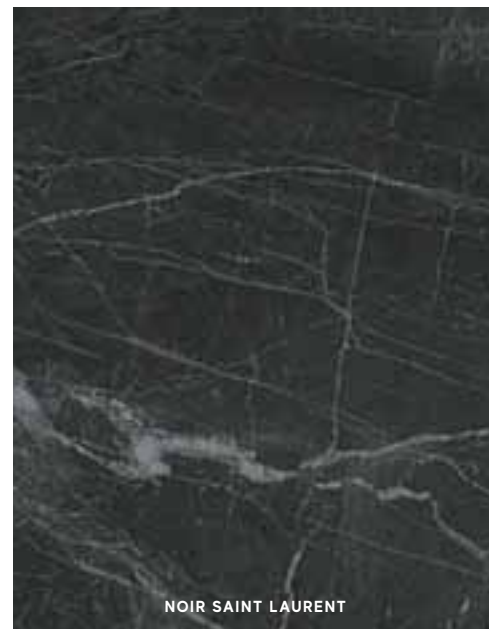

NOIR SAINT LAURENT



TRAVERTINO SILVER

### DECOR RANGE

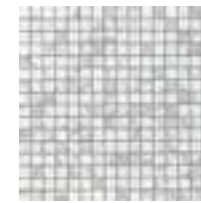

9MVS Marvel Statuario Select Mosaic  
30,5x30,5 - 12"x12"

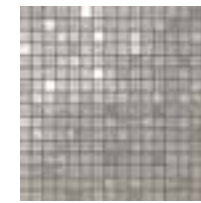

9MVE Marvel Grey Fleury Mosaic  
30,5x30,5 - 12"x12"



9MVN Marvel Noir St. Laurent Mosaic  
30,5x30,5 - 12"x12"



9MVC Marvel Crema Delicato Mosaic  
30,5x30,5 - 12"x12"



9MVT Marvel Travertino Alabastrino Mosaic  
30,5x30,5 - 12"x12"



9MVV Marvel Travertino Silver Mosaic  
30,5x30,5 - 12"x12"

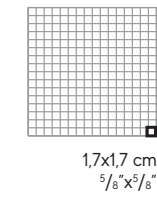

1,7x1,7 cm  
5/8"x3/8"



9MVD Marvel Grey Fleury Diagonal Mosaic  
30,5x30,5 - 12"x12"



9MVA Marvel Travertino Alabastrino Diagonal Mosaic  
30,5x30,5 - 12"x12"



9MVB Marvel Travertino Silver Diagonal Mosaic  
30,5x30,5 - 12"x12"



9MVH Marvel Noir St. Laurent Diagonal Mosaic  
30,5x30,5 - 12"x12"

Noir St. Laurent  
+ Statuario Select



9MVF Marvel Crema Delicato Diagonal Mosaic  
30,5x30,5 - 12"x12"

Crema Delicato  
+ Noir St. Laurent

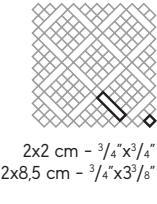

2x2 cm - 3/4"x3/4"  
2x8,5 cm - 3/4"x33/8"



9MVP Marvel Grey Fleury Net Mosaic  
30,5x30,5 - 12"x12"



9MVM Marvel Travertino Silver Net Mosaic  
30,5x30,5 - 12"x12"

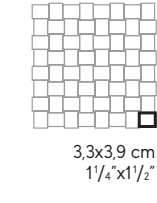

3,3x3,9 cm  
1 1/4"x1 1/2"



9MBT Marvel Travertino Alabastrino Brocade  
30,5x91,5 - 12"x36"



9MBN Marvel Noir St. Laurent Brocade  
30,5x91,5 - 12"x36"



8MHG Marvel Grey Fleury Hexagon  
40x80 - 15<sup>7</sup>/<sub>8</sub>"x31<sup>1</sup>/<sub>2</sub>"



LVGW Marvel Gold White <sup>(1)</sup>  
7,8x30,5 - 3<sup>1</sup>/<sub>8</sub>"x12"

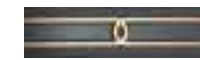

LVGB Marvel Gold Black <sup>(1)</sup>  
7,8x30,5 - 3<sup>1</sup>/<sub>8</sub>"x12"



AVGW Marvel Gold White A.E. <sup>(1)</sup>  
7,8x1,2 - 3<sup>1</sup>/<sub>8</sub>"x1/2"



AVGB Marvel Gold Black A.E. <sup>(1)</sup>  
7,8x1,2 - 3<sup>1</sup>/<sub>8</sub>"x1/2"

<sup>(1)</sup> Contains gold. The use of a common mild detergent is recommended. Avoid using acidic or alkaline products, waxes, steel wool or abrasives. - Parti in oro. Si consiglia l'utilizzo di un comune detergente neutro. Evitare l'utilizzo di prodotti acidi o alcalini, ceranti, pagliette di metallo o abrasive. - Parties dorées. Nous vous conseillons d'utiliser des détergents neutres courants. Éviter l'utilisation de cires et de produits acides ou alcalins, ainsi que les pâilles métalliques ou abrasives. - Teile aus Gold. Es empfiehlt sich, ein haushaltsübliches, neutrales Reinigungsmittel zu verwenden. Saure oder alkalische Produkte, Wachs sowie Metallwolle- bzw. Scheuerschwämme sind zu vermeiden. - Partes doradas. Recomendamos utilizar un detergente neutro común. Hay que evitar el uso de productos ácidos o alcalinos, ceras y estropajos de metal o abrasivos. - Золотые детали. Рекомендуется чистить обычным нейтральным моющим средством. Не рекомендуется использовать кислотные, щелочные, восковые средства, а также металлические мочалки.

INDEX



A COMPLETE  
PRODUCT  
SYSTEM



PRODUCT  
FINDER



SURFACE  
RANGE



COMPANY



COLLECTIONS



3D WALL  
CONCRETE & RESIN LOOK  
METAL LOOK  
MARBLE LOOK  
STONE LOOK  
WOOD LOOK

LARGE SIZES



SLABS FOR  
COUNTERTOPS  
& FURNITURE



SINKS &  
BATHROOM  
FURNISHING



FACADES



TECHNICAL  
SPECIFICATIONS





# Marvel Shine



© Ceramiche Atlas Concorde



© Ceramiche Atlas Concorde



© Ceramiche Atlas Concorde

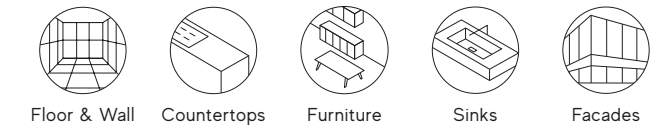
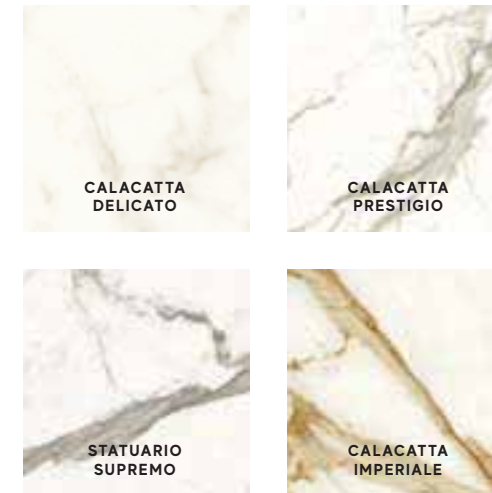

## Porcelain Tiles RECTIFIED MONOCALIBER

Sizes	Thickness	Surface finish
160x160 cm - 63"x63"	± 6 mm	Polished
120x278 cm - 47 1/4"x109 1/2"	± 6 mm	Polished I Silk
120x240 cm - 47 1/4"x94 1/2"	± 9 mm	Polished
120x120 cm - 47 1/4"x47 1/4"	± 9 mm	Polished I Matte <a href="#">Sensitech R10 B</a>
60x120 cm - 23 5/8"x47 1/4"	± 9 mm	Polished I Matte <a href="#">Sensitech R10 B</a>
75x150 cm - 29 1/2"x59"	± 9 mm	Polished I Silk
75x75 cm - 29 1/2"x29 1/2"	± 9 mm	Polished I Silk
37,5x75 cm - 14 3/4"x29 1/2"	± 9 mm	Polished
60x60 cm - 23 5/8"x23 5/8"	± 9 mm	Polished I Silk I Matte <a href="#">Sensitech R10 B</a>
30x60 cm - 11 3/4"x23 5/8"	± 9 mm	Silk

LARGE SIZES p. 356

### atlasPLAN

160x320 cm - 63"x126"	± 6 mm	Polished
-----------------------	--------	----------

### SLABS FOR COUNTERTOPS & FURNITURE

162x324 cm - 63 3/4"x127 1/2" NON-RECTIFIED	± 6-12 mm	Polished I Silk I Satin
159x324 cm - 62 5/8"x127 1/2" NON-RECTIFIED	± 20* mm	Polished I Matte

## Wall Tiles RECTIFIED MONOCALIBER

Sizes	Thickness	Surface finish
50x120 cm - 19 5/8"x47 1/4"	± 8,5 mm	Silk
40x80 cm - 15 1/4"x31 1/2"	± 8,5 mm	Shiny



\* Natura-vein tech

INDEX



A COMPLETE PRODUCT SYSTEM



PRODUCT FINDER



SURFACE RANGE



COMPANY



COLLECTIONS



3D WALL  
CONCRETE & RESIN LOOK  
METAL LOOK  
MARBLE LOOK  
STONE LOOK  
WOOD LOOK

LARGE SIZES



SLABS FOR COUNTERTOPS & FURNITURE



SINKS & BATHROOM FURNISHING



FACADES



TECHNICAL SPECIFICATIONS



# Marvel Shine

## Porcelain Tiles

### POLISHED SURFACE <sup>(1)</sup>



± 6 mm  
**160x320 cm** - 63"x126"  
 A4RR Marvel Calacatta Delicato Polished  
 A4RS Marvel Statuario Supremo Polished



± 6 mm  
**160x160 cm** - 63"x63"  
 A4RP Marvel Calacatta Prestigio Polished  
 A4RQ Marvel Statuario Supremo Polished



± 6 mm  
**120x278 cm** - 47<sup>1</sup>/<sub>4</sub>"x109<sup>1</sup>/<sub>2</sub>"  
 A4OY Marvel Calacatta Delicato Polished  
 A4OZ Marvel Calacatta Prestigio Polished  
 A4O2 Marvel Calacatta Prestigio Bookm A Lp <sup>(3)</sup> <sup>(5)</sup>  
 A4O3 Marvel Calacatta Prestigio Bookm B Lp <sup>(3)</sup> <sup>(5)</sup>  
 A6EO Marvel Calacatta Prestigio Polished Kit Endless <sup>(2)</sup> <sup>(3)</sup>  
 A4OØ Marvel Statuario Supremo Polished  
 A4O4 Marvel Statuario Supremo Bookm A Lp <sup>(3)</sup> <sup>(5)</sup>  
 A4O5 Marvel Statuario Supremo Bookm B Lp <sup>(3)</sup> <sup>(5)</sup>  
 A6EP Marvel Statuario Supremo Polished Kit Endless <sup>(2)</sup> <sup>(3)</sup>  
 A4O1 Marvel Calacatta Imperiale Polished  
 A6EQ Marvel Calacatta Imperiale Polished Kit Endless <sup>(2)</sup> <sup>(3)</sup>



± 9 mm  
**120x240 cm** - 47<sup>1</sup>/<sub>4</sub>"x94<sup>1</sup>/<sub>2</sub>"  
 A4RH Marvel Calacatta Delicato Polished  
 A4RI Marvel Calacatta Prestigio Polished  
 A4RJ Marvel Statuario Supremo Polished  
 A4RK Marvel Calacatta Imperiale Polished



± 9 mm  
**120x120 cm** - 47<sup>1</sup>/<sub>4</sub>"x47<sup>1</sup>/<sub>4</sub>"  
 A4Q8 Marvel Calacatta Delicato Polished  
 A4Q9 Marvel Calacatta Prestigio Polished  
 A4RA Marvel Statuario Supremo Polished  
 A4RB Marvel Calacatta Imperiale Polished



± 9 mm  
**60x120 cm** - 23<sup>5</sup>/<sub>8</sub>"x47<sup>1</sup>/<sub>4</sub>"  
 A4QØ Marvel Calacatta Delicato Polished  
 A4Q1 Marvel Calacatta Prestigio Polished  
 A4Q2 Marvel Statuario Supremo Polished  
 A4Q3 Marvel Calacatta Imperiale Polished



± 9 mm  
**60x60 cm** - 23<sup>5</sup>/<sub>8</sub>"x23<sup>5</sup>/<sub>8</sub>"  
 A4QS Marvel Calacatta Delicato Polished  
 A4QT Marvel Calacatta Prestigio Polished  
 A4QU Marvel Statuario Supremo Polished  
 A4QV Marvel Calacatta Imperiale Polished



± 9 mm  
**75x150 cm** - 29<sup>1</sup>/<sub>2</sub>"x59"  
 A7GA Marvel Calacatta Delicato Polished  
 A7GB Marvel Calacatta Prestigio Polished  
 A7GC Marvel Statuario Supremo Polished  
 A4PH Marvel Statuario Supremo Lp Macchia Aperta  
 A7GD Marvel Calacatta Imperiale Polished  
 A4PI Marvel Calacatta Imperiale Lp Macchia Aperta



± 9 mm  
**75x75 cm** - 29<sup>1</sup>/<sub>2</sub>"x29<sup>1</sup>/<sub>2</sub>"  
 A3WX Marvel Calacatta Delicato Polished  
 A3WY Marvel Calacatta Prestigio Polished  
 A3WZ Marvel Statuario Supremo Polished  
 A3WØ Marvel Calacatta Imperiale Polished



± 9 mm  
**37,5x75 cm** - 14<sup>3</sup>/<sub>4</sub>"x29<sup>1</sup>/<sub>2</sub>"  
 A4RL Marvel Calacatta Delicato Polished  
 A4RM Marvel Calacatta Prestigio Polished  
 A4RN Marvel Statuario Supremo Polished  
 A4RO Marvel Calacatta Imperiale Polished



V2 Slight Variation  
 Calacatta Delicato,  
 Calacatta Prestigio,  
 Statuario Supremo



V3 Moderate Variation  
 Calacatta Imperiale



CALACATTA DELICATO



CALACATTA PRESTIGIO



STATUARIO SUPREMO



CALACATTA IMPERIALE

<sup>(1)</sup> The glossy polished finish is suitable for residential or low-traffic commercial floors, where no anti-slip performance is required, and for walls. The polished glossy surface finish, surprisingly brilliant and bright, features slight irregularities typical of natural marble. The extraordinary brilliance and the easy cleaning of the surface are the result of in-depth research aimed at guaranteeing its durability over time. If the product is in direct contact with the outdoors, provide devices for absorbing moisture and dirt to prevent scratches. - La finitura lappata lucida è indicata per pavimenti residenziali o commerciali poco sollecitati, laddove non siano richieste prestazioni antiscivolo, e per rivestimenti. La finitura lappata lucida offre una superficie sorprendentemente brillante e specchiante, con lievi irregolarità tipiche dei marmi naturali. La straordinaria lucentezza e l'elevata pulibilità della superficie sono frutto di studi approfonditi e accurate ricerche tecniche volte a garantirne la persistenza nel tempo. Se il prodotto è a diretto contatto con l'esterno, prevedere dei dispositivi di assorbimento dell'umidità e della sporcizia per prevenire la formazione di graffi.

<sup>(2)</sup><sup>(3)</sup> Please read the notes at page 401

### COMPLETE YOUR PROJECT

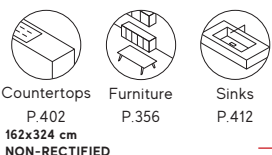

Countertops  
 P.402  
 162x324 cm  
 NON-RECTIFIED

Furniture  
 P.356

Sinks  
 P.412

INDEX



A COMPLETE PRODUCT SYSTEM



PRODUCT FINDER



SURFACE RANGE



COMPANY



COLLECTIONS



3D WALL  
 CONCRETE & RESIN LOOK  
 METAL LOOK  
 MARBLE LOOK  
 STONE LOOK  
 WOOD LOOK

LARGE SIZES



SLABS FOR COUNTERTOPS & FURNITURE



SINKS & BATHROOM FURNISHING



FACADES



TECHNICAL SPECIFICATIONS



# Marvel Shine

## Porcelain Tiles

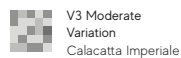
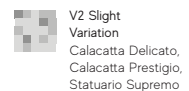

### SILK SURFACE <sup>(1)</sup>

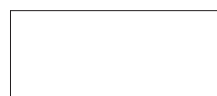

± 6 mm

120x278 cm - 47 1/4" x 109 1/2"

A4O6 Marvel Calacatta Prestigio Silk

A6ER Marvel Calacatta Prestigio Silk Kit Endless <sup>(2) (3)</sup>

A4O7 Marvel Statuario Supremo Silk

A6ES Marvel Statuario Supremo Silk Kit Endless <sup>(2) (3)</sup>



± 9 mm

75x150 cm - 29 1/2" x 59"

A7H2 Marvel Calacatta Delicato Silk

A7H3 Marvel Calacatta Prestigio Silk

A7H4 Marvel Statuario Supremo Silk

A7H5 Marvel Calacatta Imperiale Silk



± 9 mm

75x75 cm - 29 1/2" x 29 1/2"

A3W1 Marvel Calacatta Delicato Silk

A3W2 Marvel Calacatta Prestigio Silk

A3W4 Marvel Statuario Supremo Silk

A3W5 Marvel Calacatta Imperiale Silk



± 9 mm

60x60 cm - 23 5/8" x 23 5/8"

A5TC Marvel Calacatta Delicato Silk

A5TD Marvel Calacatta Prestigio Silk

A5TE Marvel Statuario Supremo Silk

A5TF Marvel Calacatta Imperiale Silk



± 9 mm

30x60 cm - 11 3/4" x 23 5/8"

A5TG Marvel Calacatta Delicato Silk

A5TH Marvel Calacatta Prestigio Silk

A5TI Marvel Statuario Supremo Silk

A5TJ Marvel Calacatta Imperiale Silk

### MATTE SURFACE

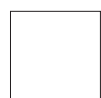

± 9 mm

120x120 cm - 47 1/4" x 47 1/4"

A4Q4 Marvel Calacatta Delicato

A4Q5 Marvel Calacatta Prestigio

A4Q6 Marvel Statuario Supremo

A4Q7 Marvel Calacatta Imperiale

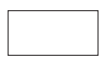

± 9 mm

60x120 cm - 23 5/8" x 47 1/4"

A4QW Marvel Calacatta Delicato

A4QX Marvel Calacatta Prestigio

A4QY Marvel Statuario Supremo

A4QZ Marvel Calacatta Imperiale



± 9 mm

60x60 cm - 23 5/8" x 23 5/8"

A4QO Marvel Calacatta Delicato

A4QQ Marvel Calacatta Prestigio

A4QR Marvel Statuario Supremo

A4QP Marvel Calacatta Imperiale

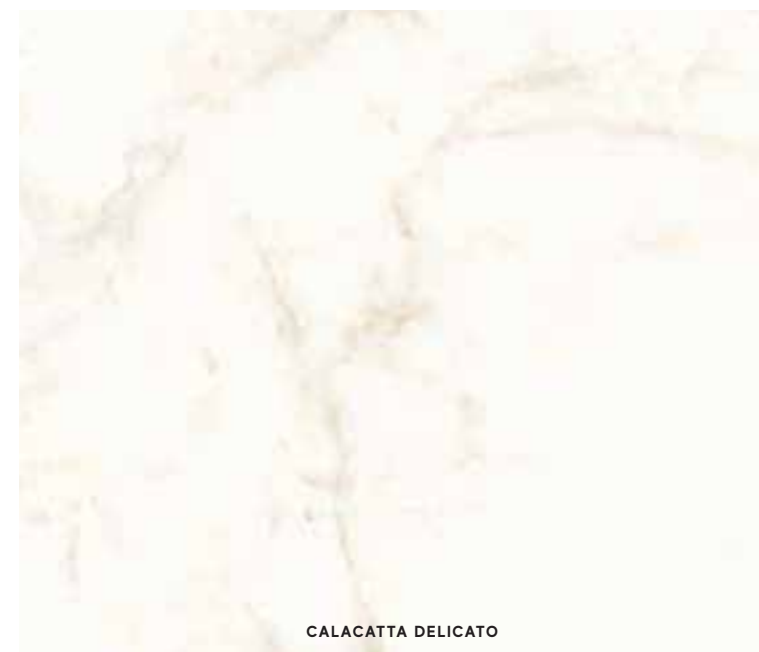

CALACATTA DELICATO



CALACATTA PRESTIGIO



STATUARIO SUPREMO



CALACATTA IMPERIALE

TRIM TILES p. 352	Battiscopa			Gradino *			Scalino *			Scalino Ang. *			Battiscopa Sag. Scala *			Corner * ± 6 mm		Corner A.E * ± 6 mm									
	7,2x150 cm 2 7/8" x 59"	7,2x120 cm 2 7/8" x 47 1/4"	7,2x60 cm 2 7/8" x 23 5/8"	30x120 cm 11 3/4" x 47 1/4"	37,5x75 cm 14 3/4" x 29 1/2"	30x60 cm 11 3/4" x 23 5/8"	37,5x150 cm 14 3/4" x 59"	33x120 cm 13" x 47 1/4"	33x60 cm 13" x 23 5/8"	37,5x37,5 cm 14 3/4" x 14 3/4"	33x33 cm 13" x 13"	7,2x30 cm 2 7/8" x 11 3/4"	DX	SX	DX	SX	DX	SX	1x120 cm 3/4" x 47 1/4"	Polish	Silk	1x1 cm 3/8" x 1/8"	Polished				
Calacatta Delicato	A43T	A43P	A535	A43H	A539	A55F	A435	A54W	A443	A44Z	A3CV	A441	A543	A45K	A45G	A45C	A547	A55B	A54G	A54K	A43X	A431	A540	A54S	A45O	-	A45U
Calacatta Prestigio	A43U	A43Q	A536	A43I	A54D	A55G	A436	A54X	A444	A44Ø	A54Ø	A44J	A544	A45L	A45H	A45D	A548	A55C	A54H	A54L	A43Y	A432	A54P	A54T	A45P	A45S	A45X
Statuario Supremo	A43V	A43R	A537	A43J	A54E	A55H	A437	A54Y	A445	A441	A541	A44K	A545	A45M	A45I	A45E	A549	A55D	A54I	A54M	A43Z	A433	A54Q	A54U	A45Q	A45T	A45W
Calacatta Imperiale	A43W	A43S	A538	A43K	A54F	A55I	A438	A54Z	A446	A442	A542	A44L	A546	A45N	A45J	A45F	A55A	A55E	A54J	A54N	A43Ø	A434	A54R	A54V	A45R	-	A45V

\* These parts are supplied to order - I pezzi sono disponibili su ordinazione - Les pièces sont disponibles sur commande - Die Teile sind auf Bestellung lieferbar - Las piezas se hacen por encargo - Изготавливаются на заказ

<sup>(1)</sup> The silk finish is suitable for residential or low-traffic commercial floors, where no anti-slip performance is required. The surface's shine and great ease of cleaning are the result of in-depth studies and technical research aimed at ensuring its durability over time. If the product is in direct contact with the outdoors, moisture and dirt absorption devices must be used to prevent scratching. - La finitura silk è indicata per pavimenti residenziali o commerciali poco sollecitati, laddove non siano richieste prestazioni anticivolo. La lucentezza e l'elevata facilità di pulizia della superficie sono frutto di studi approfonditi e accurate ricerche tecniche volte a garantirne la persistenza nel tempo. Se il prodotto è a diretto contatto con l'esterno, prevedere dei dispositivi di assorbimento dell'umidità e dello sporco per prevenire la formazione di graffi.

<sup>(2) (3)</sup> Please read the notes at page 401

**COMPLETE YOUR PROJECT**

Countertops  
P.402  
162x324 cm  
NON-RECTIFIED

Furniture  
P.356

Sinks  
P.412

Facades  
P.436

- INDEX
- A COMPLETE PRODUCT SYSTEM
- PRODUCT FINDER
- SURFACE RANGE
- COMPANY
- COLLECTIONS
- 3D WALL  
CONCRETE & RESIN LOOK  
METAL LOOK  
MARBLE LOOK  
STONE LOOK  
WOOD LOOK
- LARGE SIZES
- SLABS FOR COUNTERTOPS & FURNITURE
- SINKS & BATHROOM FURNISHING
- FACADES
- TECHNICAL SPECIFICATIONS

# Marvel Shine

## Porcelain Tiles

### MACCHIA APERTA, SUGGESTED COMPOSITION

A4PI Marvel Calacatta Imperiale Lappato Macchia Aperta - 75x150 - 29 1/2" x 59"

LAYOUT A

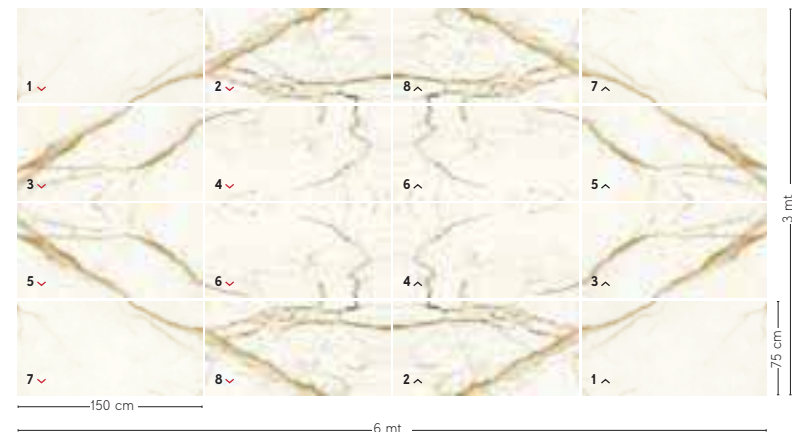

LAYOUT B



LAYOUT C

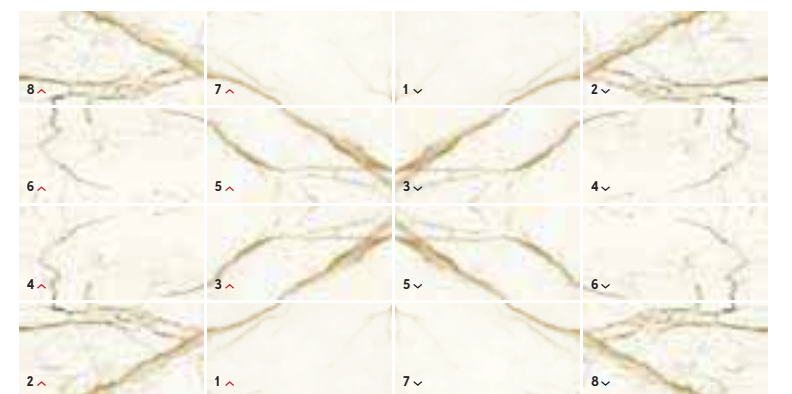

LAYOUT D



A4PH Marvel Statuario Supremo Lappato Macchia Aperta - 75x150 - 29 1/2" x 59"

LAYOUT E



LAYOUT F

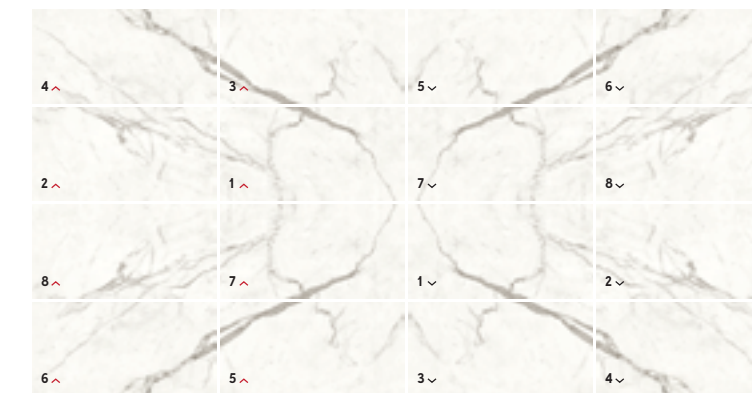

LAYOUT G

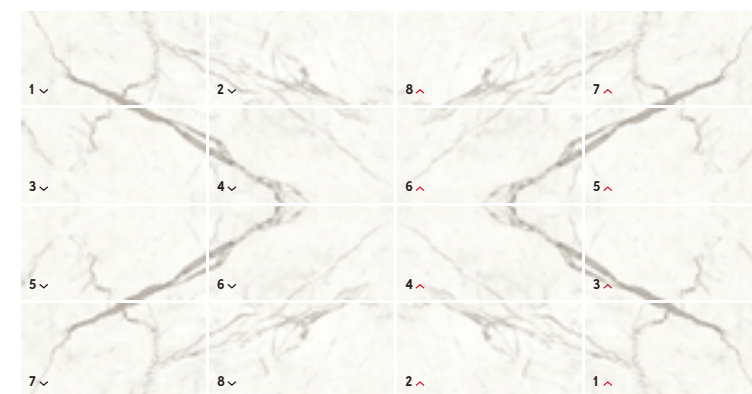

LAYOUT H

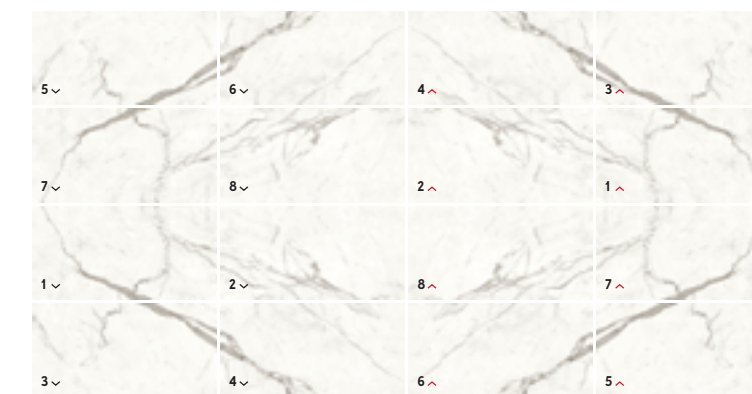

The collection allows creating an open vein measuring 6 m x 3 m (16 75x150 slabs) ideal for large rooms where you can enhance the entire interior design. The junction between the graphics that make up the open vein is not geometrically perfect but imitates the natural irregularity of the open veins of natural marble products. The code "polished open vein" corresponds to a pallet composed of 16 tiles in the 75x150 cm (8+8) format that make up the entire open vein. A number is printed on the edge of each tile (see laying diagram).

La collezione permette di creare una macchia aperta di dimensioni 6 m x 3 m (16 facce di 75x150) ideale per ambienti ampi nei quali poter valorizzare l'intera composizione. La giunzione tra le grafiche che compongono la macchia aperta non è geometricamente perfetta ma imita la naturale irregolarità delle macchie aperte dei prodotti in marmo naturale. Il codice "lappato macchia aperta" corrisponde ad un pallet composto da 16 piastrelle in formato 75cmx150cm (8+8) che compongono l'intera macchia aperta. Sulla costa di ciascuna piastrella è stampato il numero corrispondente (vedi schema di posa).

La collection permet de créer une tache ouverte de 6 m x 3 m (16 faces de 75x150) idéale pour les grandes pièces où l'on peut mettre en valeur l'ensemble de la composition. La jonction entre les graphismes qui composent la tache ouverte n'est pas géométriquement parfaite mais imite l'irrégularité naturelle des taches ouvertes des produits en marbre naturel. Le code "lappato macchia aperta" (tache ouverte rodée) correspond à une palette composée de 16 carreaux au format 75cmx150cm (8+8) qui constituent la totalité de la tache ouverte. Le numéro correspondant est imprimé sur le bord de chaque carreau (voir schéma de pose).

Die Kollektion erlaubt die Bildung einer Spiegeloptik mit den Abmessungen 6 m x 3 m (16 verschiedenen Oberflächen 75 x 150). Ideal in weitläufigen Räumen, in denen die Komposition optimal zur Geltung gebracht werden kann. Der Anschluss zwischen den einzelnen Grafikbildern, die den Spiegeleffekt bilden, ist geometrisch nicht perfekt, sondern empfindet die natürliche Unregelmäßigkeit der mit Naturmarmor erzielten Spiegeloptik nach. Die Artikelbezeichnung „geläpft gespiegelt“ entspricht einer Palette mit 16 Fliesen im Format 75 cm x 150 cm (8+8), die das gesamte, gespiegelte Motiv bilden. Jede Fliese ist an der Seite nummeriert (siehe Verlegeplan).

La colección permite crear una mancha abierta de 6 m x 3 m (16 caras de 75x150) ideal para ambientes amplios donde se puede realizar toda la composición. La unión entre los gráficos que componen la mancha abierta no es geoméricamente perfecta, sino que imita la natural irregularidad de las manchas abiertas de los productos de mármol natural. El código «lapeado mancha abierta» corresponde a una paleta compuesta de 16 baldosas de formato 75cmx150cm (8+8) que componen toda la mancha abierta. El número correspondiente está impreso en el borde de cada baldosa (ver diagrama de colocación).

Коллекция позволяет создавать облицовку с симметричным зеркальным рисунком 6 м x 3 м (16 плит 75x150). Данная композиция максимально раскрывает свой потенциал в больших помещениях. Стык между плитами, которые образуют симметричный рисунок, не является геометрически совершенным, а имитирует естественную неровность аналогичных рисунков, составляемых из плит природного мрамора. Код «лапатированный с симметричным зеркальным рисунком» соответствует поддону, состоящему из 16 плит формата 75 см x 150 см (8+8), из которых складывается данный симметричный рисунок. На торце каждой из плит напечатан соответствующий номер (см. схему укладки).

The miniatures are not in proportion. - I minimali non sono in proporzione. - Les illustrations à échelle réduite ne sont pas proportionnelles. - Die Abbildungen sind nicht verhältnismäßig. - Los miniaturas no están en proporción. - Изображения не соблюдают пропорций.



- 3D WALL
- CONCRETE & RESIN LOOK
- METAL LOOK
- MARBLE LOOK
- STONE LOOK
- WOOD LOOK



# Marvel Shine

## Porcelain Tiles

### DECOR RANGE

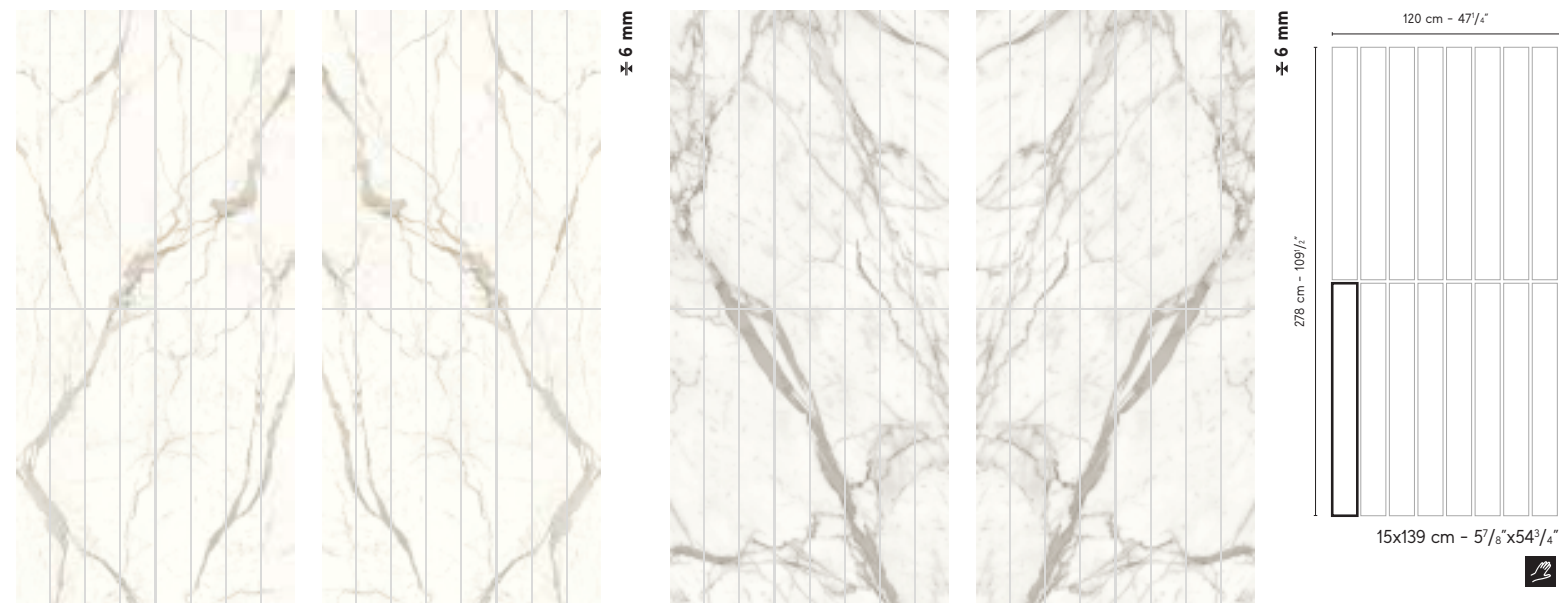

A421 Marvel Calacatta Prestigio Scenic Bookm A Lp <sup>(1)</sup>  
120x278 - 47 1/4" x 109 1/2"

A43L Marvel Calacatta Prestigio Scenic Bookm B Lp <sup>(1)</sup>  
120x278 - 47 1/4" x 109 1/2"

A43O Marvel Statuario Supremo Scenic Bookm A Lp <sup>(1)</sup>  
120x278 - 47 1/4" x 109 1/2"

A43M Marvel Statuario Supremo Scenic Bookm B Lp <sup>(1)</sup>  
120x278 - 47 1/4" x 109 1/2"



A42Z Marvel Mosaico Match Polished 29,2x33,7 - 11 1/2" x 13 1/4" <sup>(2)</sup>  
Calacatta Delicato + Calacatta Prestigio + Blaze Corten + Boost Pro Tobacco

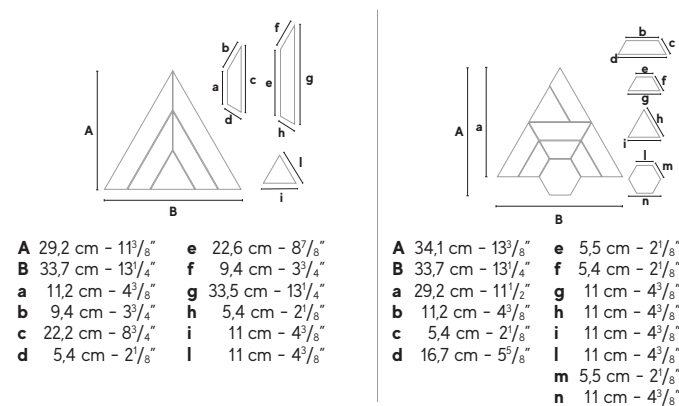

<sup>(1)</sup> 120x278 cm slabs cut into modules that recombine the open vein. This makes it possible to lay them even on curved surfaces. Each slab is cut into 16 numbered modules measuring 15x139 cm. To recreate the open vein, follow the sequence of pieces indicated in the laying patterns inside the packaging. Each slab is placed in 4 boxes, each of which contains 4 modules, for a total of 16 modules, corresponding to a surface of 3.3 mq. - Lastre 120cmx278cm tagliata in moduli che ricompongono la macchia aperta. Consentono la posa anche su superfici curve. Ogni lastra viene tagliata in 16 moduli numerati, di dimensione 15cmx139cm; per ricreare la macchia aperta seguire la sequenza dei pezzi indicata negli schemi di posa all'interno dell'imballo. Ogni lastra viene collocata in 4 scatole, ciascuna delle quali contiene 4 moduli, per un totale di 16 moduli, corrispondenti ad una superficie di 3,3mq. - Dalles de 120 cm x 278 cm découpées en modules qui reconstituent la tache ouverte. Elles permettent la pose même sur des surfaces courbes. Chaque dalle est découpée en 16 modules numérotés, mesurant 15 cm x 139 cm; pour recréer la tache ouverte, suivez la séquence de pièces indiquée dans les schémas de pose à l'intérieur de l'emballage. Chaque dalle est placée dans 4 boîtes contenant chacune 4 modules, pour un total de 16 modules, correspondant à une surface de 3,3 mètres carrés. - Platten 120 cm x 278 cm, zu Modulen geschritten, die das gespiegelte Motiv bilden. Die Verlegung ist auch auf gewölbten Oberflächen möglich. Jede Platte wird in 16 nummerierte Module mit Abmessungen 15 cm x 139 cm geschritten. Um die Spiegeloptik zu erzielen, die auf den die Verpackung beiliegenden Verlegeplänen angegebene Reihenfolge beachten. Jede Platte wird in 4 Schachteln mit je 4 Modulen verpackt. Die insgesamt 16 Module entsprechen einer Oberfläche von 3,3 qm. - Placas 120cmx278cm cortadas en módulos que recomponen la mancha abierta. También permiten la colocación en superficies curvas. Cada losa se corta en 16 módulos numerados que miden 15cmx139cm; para recrear la mancha abierta, se sigue la secuencia de las piezas indicadas en los esquemas de colocación dentro del embalaje. Cada losa se coloca en 4 cajas, cada una de estas contiene 4 módulos por un total de 16 módulos, lo que corresponde a un área de 3,3 metros cuadrados. - Плиты 120 см x 278 см разрезаются на модули, которые впоследствии складываются в симметричный зеркальный рисунок. Также возможна укладка на изогнутые поверхности. Каждая плита разрезается на 16 пронумерованных модулей размером 15 см x 139 см; чтобы заново сложить исходный симметричный рисунок, необходимо соблюдать последовательность, указанную на схемах укладки внутри упаковки. Каждая плита помещается в 4 коробки по 4 модуля, всего - 16 модулей, соответствующих площади 3,3 кв.м.

<sup>(2)</sup> The decoration can only be laid on the wall - Il decoro si può posare solo a rivestimento - Décor uniquement mural - Das Dekor kann nur an der Wand verlegt werden. La decoración se puede colocar únicamente en paredes - Декор может быть уложен только на стену.

<sup>(3)</sup> A random laying pattern is recommended. Each box contains 8 elements comprising the composition shown in the figure. - Si consiglia uno schema di posa casuale. Ogni scatola contiene la composizione degli 8 elementi rappresentata in figura. - Un schéma de pose casuelle est conseillé. Chaque boîte contient la composition des 8 éléments indiqués dans l'image. - Es empfiehlt sich die Verlegung nach dem Zufallsprinzip. Jede Schachtel enthält die abgebildete Komposition aus den 8 Elementen. - Se recomienda un esquema aleatorio de colocación. Cada caja contiene la composición de los 8 elementos que se muestran en la figura. - Рекомендуется произвольная схема укладки. Каждая коробка содержит композицию из 8 элементов, показанную на рисунке.



A423 Marvel Calacatta Delicato Mosaico Polished 30x30 - 1 1/4" x 1 1/4"



A424 Marvel Calacatta Prestigio Mosaico Polished 30x30 - 1 1/4" x 1 1/4"

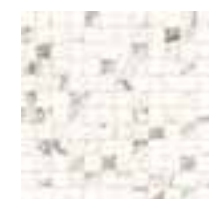

A425 Marvel Statuario Supremo Mosaico Polished 30x30 - 1 1/4" x 1 1/4"



A426 Marvel Calacatta Imperiale Mosaico Polished 30x30 - 1 1/4" x 1 1/4"

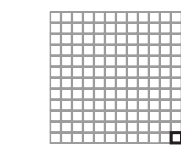

2,3x2,3 cm - 7/8" x 7/8"



A413 Marvel Calacatta Delicato Mosaico Matte 30x30 - 1 1/4" x 1 1/4"



A414 Marvel Calacatta Prestigio Mosaico Matte 30x30 - 1 1/4" x 1 1/4"



A415 Marvel Statuario Supremo Mosaico Matte 30x30 - 1 1/4" x 1 1/4"



A416 Marvel Calacatta Imperiale Mosaico Matte 30x30 - 1 1/4" x 1 1/4"

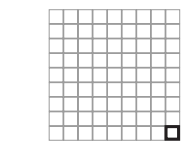

3,1x3,1 cm - 1 1/4" x 1 1/4"



A42K Marvel Calacatta Delicato Mosaico Esagono Polished 30,5x35,2 - 12" x 13 7/8"



A42W Marvel Calacatta Prestigio Mosaico Esagono Polished 30,5x35,2 - 12" x 13 7/8"



A42X Marvel Statuario Supremo Mosaico Esagono Polished 30,5x35,2 - 12" x 13 7/8"



A42Y Marvel Calacatta Imperiale Mosaico Esagono Polished 30,5x35,2 - 12" x 13 7/8"

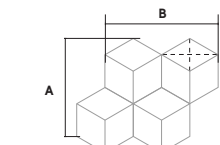

**A** 30,5 cm - 12"  
**B** 35,2 cm - 13 7/8"  
10x17 cm - 3 7/8" x 6 1/4"



A417 Marvel Calacatta Delicato Mosaico Esagono Matte 30,5x35,2 - 12" x 13 7/8"



A418 Marvel Calacatta Prestigio Mosaico Esagono Matte 30,5x35,2 - 12" x 13 7/8"



A419 Marvel Statuario Supremo Mosaico Esagono Matte 30,5x35,2 - 12" x 13 7/8"



A42J Marvel Calacatta Imperiale Mosaico Esagono Matte 30,5x35,2 - 12" x 13 7/8"

# Marvel Shine

## Wall Tiles

### SILK SURFACE



± 8,5 mm

50x120 cm - 19<sup>5</sup>/<sub>8</sub>"x47<sup>1</sup>/<sub>4</sub>"

A4TT Marvel Calacatta Delicato Silk

A4TU Marvel Calacatta Prestigio Silk

A4TV Marvel Statuario Supremo Silk

A4TW Marvel Calacatta Imperiale Silk

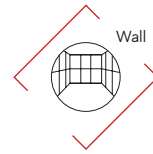

### SHINY SURFACE

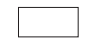

± 8,5 mm

40x80 cm - 15<sup>3</sup>/<sub>4</sub>"x31<sup>1</sup>/<sub>2</sub>"

A3ZS Marvel Calacatta Delicato Shiny

A3ZT Marvel Calacatta Prestigio Shiny

A3ZU Marvel Statuario Supremo Shiny

A3ZV Marvel Calacatta Imperiale Shiny

### TRIM TILES



1,4x50 cm - 5<sup>5</sup>/<sub>8</sub>"x19<sup>5</sup>/<sub>8</sub>"

A41D Marvel Calacatta Delicato Corner 50 Silk \*

A41E Marvel Calacatta Prestigio Corner 50 Silk \*

A41F Marvel Statuario Supremo Corner 50 Silk \*

A41G Marvel Calacatta Imperiale Corner 50 Silk \*



1,4x40 cm - 5<sup>5</sup>/<sub>8</sub>"x15<sup>3</sup>/<sub>4</sub>"

A41H Marvel Calacatta Delicato Corner 40 Shiny \*

A41I Marvel Calacatta Prestigio Corner 40 Shiny \*

A41J Marvel Statuario Supremo Corner 40 Shiny \*

A41K Marvel Calacatta Imperiale Corner 40 Shiny \*



1,4x1,4 cm - 5<sup>5</sup>/<sub>8</sub>"x5<sup>5</sup>/<sub>8</sub>"

A41L Marvel Calacatta Delicato Corner A.E. \*

A41M Marvel Calacatta Prestigio Corner A.E. \*

A41N Marvel Statuario Supremo Corner A.E. \*

A41O Marvel Calacatta Imperiale Corner A.E. \*

\* These parts are supplied to order - I pezzi sono disponibili su ordinazione - Les pièces sont disponibles sur commande - Die Teile sind auf Bestellung lieferbar - Las piezas se hacen por encargo - Изготавливаются на заказ

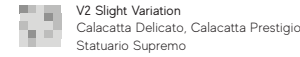

V2 Slight Variation  
Calacatta Delicato, Calacatta Prestigio,  
Statuario Supremo



V3 Moderate Variation  
Calacatta Imperiale



CALACATTA DELICATO



CALACATTA PRESTIGIO



STATUARIO SUPREMO

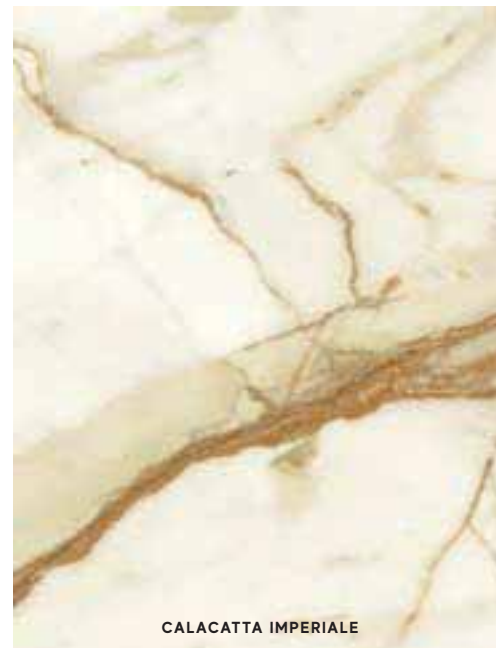

CALACATTA IMPERIALE

### DECOR RANGE



A4WK Marvel  
Calacatta Delicato  
Mosaico Twist Shiny  
30,5x30,5 - 12"x12"



A4WL Marvel  
Calacatta Prestigio  
Mosaico Twist Shiny  
30,5x30,5 - 12"x12"



A4WM Marvel  
Statuario Supremo  
Mosaico Twist Shiny  
30,5x30,5 - 12"x12"



A4WN Marvel  
Calacatta Imperiale  
Mosaico Twist Shiny  
30,5x30,5 - 12"x12"



A4WO Marvel  
Calacatta Delicato  
Mosaico Twist Silk  
30,5x30,5 - 12"x12"



A4WP Marvel  
Calacatta Prestigio  
Mosaico Twist Silk  
30,5x30,5 - 12"x12"



A4WQ Marvel  
Statuario Supremo  
Mosaico Twist Silk  
30,5x30,5 - 12"x12"



A4WR Marvel  
Calacatta Imperiale  
Mosaico Twist Silk  
30,5x30,5 - 12"x12"



A4WT Marvel  
Calacatta Delicato  
Gold Hex Shiny <sup>(1)</sup>  
25,1x29 - 9<sup>7</sup>/<sub>8</sub>"x11<sup>1</sup>/<sub>8</sub>"



A4WU Marvel  
Calacatta Prestigio  
Gold Hex Shiny <sup>(1)</sup>  
25,1x29 - 9<sup>7</sup>/<sub>8</sub>"x11<sup>1</sup>/<sub>8</sub>"



A4WV Marvel  
Statuario Supremo  
Platino Hex Shiny <sup>(1)</sup>  
25,1x29 - 9<sup>7</sup>/<sub>8</sub>"x11<sup>1</sup>/<sub>8</sub>"



A4WW Marvel  
Calacatta Imperiale  
Gold Hex Shiny <sup>(1)</sup>  
25,1x29 - 9<sup>7</sup>/<sub>8</sub>"x11<sup>1</sup>/<sub>8</sub>"



A4WS Marvel  
Calacatta Prestigio  
Rose Hex Silk  
25,1x29 - 9<sup>7</sup>/<sub>8</sub>"x11<sup>1</sup>/<sub>8</sub>"

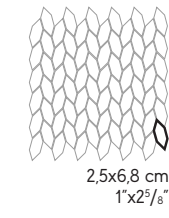

2,5x6,8 cm  
1"x2<sup>5</sup>/<sub>8</sub>"

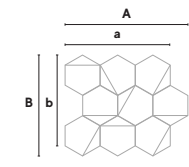

A 33,9 cm - 13<sup>3</sup>/<sub>8</sub>"  
a 29 cm - 11<sup>1</sup>/<sub>8</sub>"  
B 27,9 cm - 11"  
b 25,1 cm - 9<sup>7</sup>/<sub>8</sub>"

<sup>(1)</sup> Contains gold. The use of a common mild detergent is recommended. Avoid using acidic or alkaline products, waxes, steel wool, or abrasives. - Parti in oro. Si consiglia l'utilizzo di un comune detergente neutro. Evitare l'utilizzo di prodotti acidi o alcalini, ceranti, pagliette di metallo o abrasive. - Parties dorées. Nous vous conseillons d'utiliser des détergents neutres courants. Éviter l'utilisation de cires et de produits acides ou alcalins, ainsi que les pailles métalliques ou abrasives - Teile aus Gold. Es empfiehlt sich, ein haushaltsübliches, neutrales Reinigungsmittel zu verwenden. Saure oder alkalische Produkte, Wachs sowie Metallwolle- bzw. Scheuerschwämme sind zu vermeiden. - Partes doradas. Recomendamos utilizar un detergente neutro común. Hay que evitar el uso de productos ácidos o alcalinos, ceras y estropajos de metal o abrasivos. - Золотые детали. Рекомендуется чистить обычным нейтральным моющим средством. Не рекомендуется использовать кислотные, щелочные, восковые средства, а также металлические мочалки.

INDEX



A COMPLETE  
PRODUCT  
SYSTEM



PRODUCT  
FINDER



SURFACE  
RANGE



COMPANY



COLLECTIONS



3D WALL  
CONCRETE & RESIN LOOK  
METAL LOOK  
MARBLE LOOK  
STONE LOOK  
WOOD LOOK

LARGE SIZES



SLABS FOR  
COUNTERTOPS  
& FURNITURE



SINKS &  
BATHROOM  
FURNISHING



FACADES



TECHNICAL  
SPECIFICATIONS



# Marvel Stone

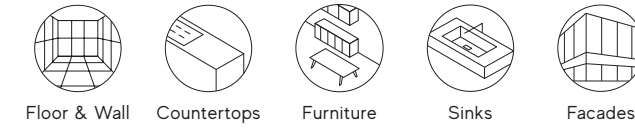

© Ceramiche Atlas Concorde



© Ceramiche Atlas Concorde



© Ceramiche Atlas Concorde

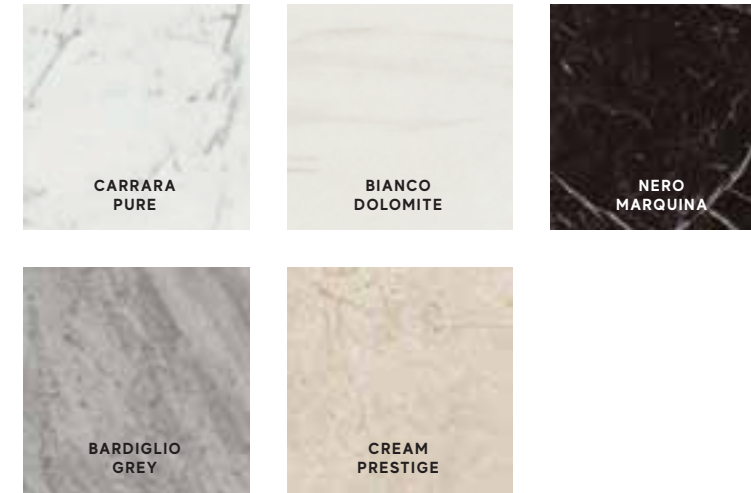

**Porcelain Tiles** RECTIFIED MONOCALIBER

Sizes	Thickness	Surface finish
160x160 cm - 63"x63"	± 6 mm	Polished
120x278 cm - 47 1/4"x109 1/2"	± 6 mm	Polished   Matte <b>Sensitech R10 B</b>
120x240 cm - 47 1/4"x94 1/2"	± 9 mm	Polished
120x120 cm - 47 1/4"x47 1/4"	± 9 mm	Polished   Matte <b>Sensitech R10 B</b>
60x120 cm - 23 5/8"x47 1/4"	± 9 mm	Polished   Matte <b>Sensitech R10 B</b>
75x150 cm - 29 1/2"x59"	± 9 mm	Polished
75x75 cm - 29 1/2"x29 1/2"	± 9 mm	Polished
60x60 cm - 23 5/8"x23 5/8"	± 9 mm	Polished   Matte <b>Sensitech R10 B</b>
30x60 cm - 11 7/8"x23 5/8"	± 9 mm	Polished   Matte <b>Sensitech R10 B</b>

LARGE SIZES p. 356

MARVEL STONE COLLECTION STONE LOOK p. 292

**atlasPLAN**

160x320 cm - 63"x126"	± 6 mm	Polished
<b>SLABS FOR COUNTERTOPS &amp; FURNITURE</b>		
162x324 cm - 63 3/4"x127 1/2" NON-RECTIFIED	± 6-12-20 mm	Polished   Silk   Matte
159x324 cm - 62 5/8"x127 1/2" NON-RECTIFIED	± 20* mm	Polished

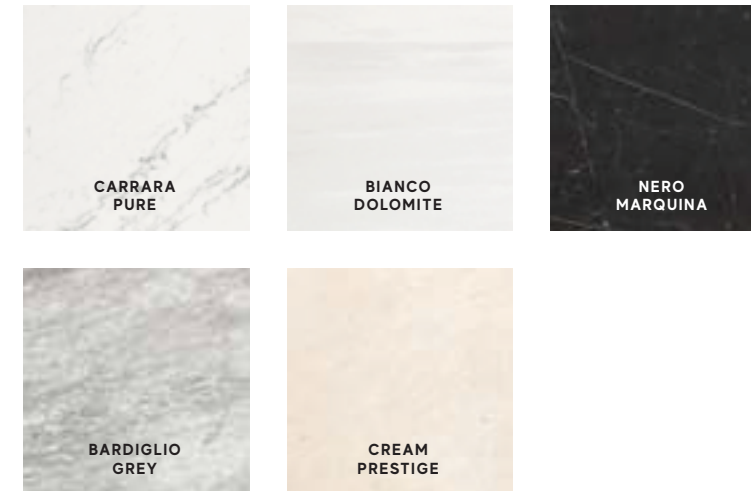

**Wall Tiles** RECTIFIED MONOCALIBER

Sizes	Thickness	Surface finish
50x120 cm - 19 5/8"x47 1/4"	± 8,5 mm	Shiny
40x80 cm - 15 7/8"x31 1/2"	± 8,5 mm	Shiny
8x31,5 cm - 3 1/8"x12 3/8"	± 8,5 mm	Shiny

INDEX

A COMPLETE PRODUCT SYSTEM

PRODUCT FINDER

SURFACE RANGE

COMPANY

COLLECTIONS

- 3D WALL
- CONCRETE & RESIN LOOK
- METAL LOOK
- MARBLE LOOK
- STONE LOOK
- WOOD LOOK

LARGE SIZES

SLABS FOR COUNTERTOPS & FURNITURE

SINKS & BATHROOM FURNISHING

FACADES

TECHNICAL SPECIFICATIONS

# Marvel Stone

## Porcelain Tiles

### POLISHED SURFACE <sup>(1)</sup>



± 6 mm  
**160x320 cm** - 63"x126"  
 AO5X Marvel Bianco Dolomite Polished



± 6 mm  
**160x160 cm** - 63"x63"  
 AO53 Marvel Bianco Dolomite Polished



± 6 mm  
**120x278 cm** - 47 1/4"x109 1/2"  
 AØBP Marvel Bianco Dolomite Polished  
 A2RW Marvel Carrara Pure Polished



± 9 mm  
**120x240 cm** - 47 1/4"x94 1/2"  
 AZTV Marvel Bianco Dolomite Polished  
 AZTW Marvel Carrara Pure Polished



± 9 mm  
**120x120 cm** - 47 1/4"x47 1/4"  
 AZTT Marvel Bianco Dolomite Polished  
 AZTU Marvel Carrara Pure Polished



± 9 mm  
**60x120 cm** - 23 5/8"x47 1/4"  
 AZ1K Marvel Bianco Dolomite Polished  
 AKSØ Marvel Carrara Pure Polished



± 9 mm  
**60x60 cm** - 23 5/8"x23 5/8"  
 AZRI Marvel Bianco Dolomite Polished  
 AZRJ Marvel Cream Prestige Polished  
 AZRK Marvel Bardiglio Grey Polished  
 AZRL Marvel Carrara Pure Polished  
 AZRM Marvel Nero Marquina Polished



± 9 mm  
**30x60 cm** - 11 3/4"x23 5/8"  
 DØ39 Marvel Bianco Dolomite Polished  
 DØ4Ø Marvel Cream Prestige Polished  
 DØ41 Marvel Bardiglio Grey Polished  
 DØ44 Marvel Carrara Pure Polished  
 DØ45 Marvel Nero Marquina Polished



± 9 mm  
**75x150 cm** - 29 1/2"x59"  
 A7GE Marvel Bianco Dolomite Polished  
 A7GF Marvel Cream Prestige Polished  
 A7GG Marvel Bardiglio Grey Polished  
 A7GH Marvel Carrara Pure Polished  
 A7GI Marvel Nero Marquina Polished



± 9 mm  
**75x75 cm** - 29 1/2"x29 1/2"  
 AZNH Marvel Bianco Dolomite Polished  
 AZNI Marvel Cream Prestige Polished  
 AZNJ Marvel Bardiglio Grey Polished  
 AZNK Marvel Carrara Pure Polished  
 AZNL Marvel Nero Marquina Polished



<sup>(1)</sup> The glossy polished finish is suitable for residential or low-traffic commercial floors, where no anti-slip performance is required, and for walls. The polished glossy surface finish, surprisingly brilliant and bright, features slight irregularities typical of natural marble. The extraordinary brilliance and the easy cleaning of the surface are the result of in-depth research aimed at guaranteeing its durability over time. If the product is in direct contact with the outdoors, provide devices for absorbing moisture and dirt to prevent scratches. - La finitura lappata lucida è indicata per pavimenti residenziali o commerciali poco sollecitati, laddove non siano richieste prestazioni antiscivolo, e per rivestimenti. La finitura lappata lucida offre una superficie sorprendentemente brillante e specchiante, con lievi irregolarità tipiche dei marmi naturali. La straordinaria lucentezza e l'elevata pulibilità della superficie sono frutto di studi approfonditi e accurate ricerche tecniche volte a garantirne la persistenza nel tempo. Se il prodotto è a diretto contatto con l'esterno, prevedere dei dispositivi di assorbimento dell'umidità e della sporcizia per prevenire la formazione di graffi.

### COMPLETE YOUR PROJECT

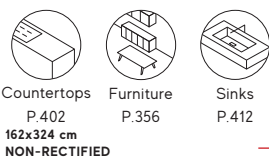

INDEX



A COMPLETE PRODUCT SYSTEM



PRODUCT FINDER



SURFACE RANGE



COMPANY



COLLECTIONS



3D WALL  
 CONCRETE & RESIN LOOK  
 METAL LOOK  
 MARBLE LOOK  
 STONE LOOK  
 WOOD LOOK

LARGE SIZES



SLABS FOR COUNTERTOPS & FURNITURE



SINKS & BATHROOM FURNISHING



FACADES



TECHNICAL SPECIFICATIONS





# Marvel Stone

## Porcelain Tiles

### MATTE SURFACE

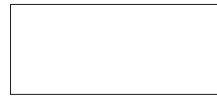

± 6 mm  
**120x278 cm** - 47<sup>1</sup>/<sub>4</sub>"x109<sup>1</sup>/<sub>2</sub>"  
 A2RS Marvel Bianco Dolomite  
 A2RV Marvel Carrara Pure



± 9 mm  
**120x120 cm** - 47<sup>1</sup>/<sub>4</sub>"x47<sup>1</sup>/<sub>4</sub>"  
 A2Ø4 Marvel Bianco Dolomite  
 A2Ø7 Marvel Carrara Pure



± 9 mm  
**60x120 cm** - 23<sup>5</sup>/<sub>8</sub>"x47<sup>1</sup>/<sub>4</sub>"  
 A21C Marvel Bianco Dolomite  
 A21E Marvel Carrara Pure



± 9 mm  
**60x60 cm** - 23<sup>5</sup>/<sub>8</sub>"x23<sup>5</sup>/<sub>8</sub>"  
 AZQS Marvel Bianco Dolomite  
 AZQT Marvel Cream Prestige  
 AZQU Marvel Bardiglio Grey  
 AZQV Marvel Carrara Pure  
 AZQW Marvel Nero Marquina



± 9 mm  
**30x60 cm** - 11<sup>3</sup>/<sub>4</sub>"x23<sup>5</sup>/<sub>8</sub>"  
 D11Ø Marvel Bianco Dolomite  
 D111 Marvel Cream Prestige  
 D112 Marvel Bardiglio Grey  
 D113 Marvel Carrara Pure  
 D114 Marvel Nero Marquina



Matte ± 6 mm



Matte ± 9 mm



BIANCO DOLOMITE



CARRARA PURE



CREAM PRESTIGE



BARDIGLIO GREY



NERO MARQUINA

### TRIM TILES p. 352

	Battiscopa				Gradino *	Scalino *	Scalino Ang. *	Battiscopa Sag. Scala *			
	Matte	Polished	Matte	Polished				DX	SX	DX	SX
Bianco Dolomite	ATDT	ATDO	ATDJ	ATDE	ATDY	ATD3	DX	ATEO	ATEJ		
Cream Prestige	ATDU	ATDP	ATDK	ATDF	ATDZ	ATD4	ATEF	ATEP	ATEK		
Bardiglio Grey	ATDV	ATDQ	ATDL	ATDG	ATDØ	ATD5	ATEG	ATEQ	ATEL		
Carrara Pure	ATDW	ATDR	ATDM	ATDH	ATD1	ATD6	ATEH	ATER	ATEM		
Nero Marquina	ATDX	ATDS	ATDN	ATDI	ATD2	ATD7	ATEI	ATES	ATEN		

\* These parts are supplied to order - I pezzi sono disponibili su ordinazione - Les pièces sont disponibles sur commande - Die Teile sind auf Bestellung lieferbar - Las piezas se hacen por encargo - Изготавливаются на заказ

### COMPLETE YOUR PROJECT

- Countertops P.402 162x324 cm NON-RECTIFIED
- Furniture P.356
- Sinks P.412
- Facades P.436



A COMPLETE PRODUCT SYSTEM >

PRODUCT FINDER >

SURFACE RANGE >

COMPANY >

COLLECTIONS >

- 3D WALL
- CONCRETE & RESIN LOOK
- METAL LOOK
- MARBLE LOOK
- STONE LOOK
- WOOD LOOK

LARGE SIZES >

SLABS FOR COUNTERTOPS & FURNITURE >

SINKS & BATHROOM FURNISHING >

FACADES >

TECHNICAL SPECIFICATIONS >

# Marvel Stone

## Porcelain Tiles

### DECOR RANGE

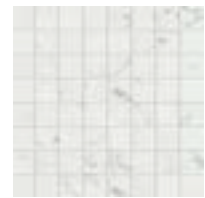

AS3Y Marvel Carrara Pure Mosaico Matte  
30x30 - 1<sup>1</sup>/<sub>4</sub>"x1<sup>1</sup>/<sub>4</sub>"



AS3V Marvel Bianco Dolomite Mosaico Matte  
30x30 - 1<sup>1</sup>/<sub>4</sub>"x1<sup>1</sup>/<sub>4</sub>"



AS3W Marvel Cream Prestige Mosaico Matte  
30x30 - 1<sup>1</sup>/<sub>4</sub>"x1<sup>1</sup>/<sub>4</sub>"



AS3X Marvel Bardiglio Grey Mosaico Matte  
30x30 - 1<sup>1</sup>/<sub>4</sub>"x1<sup>1</sup>/<sub>4</sub>"



AS3Z Marvel Nero Marquina Mosaico Matte  
30x30 - 1<sup>1</sup>/<sub>4</sub>"x1<sup>1</sup>/<sub>4</sub>"

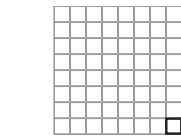

3,5x3,5 cm - 1<sup>1</sup>/<sub>8</sub>"x1<sup>1</sup>/<sub>8</sub>"



AS3T Marvel Carrara Pure Mosaico Polished  
30x30 - 1<sup>1</sup>/<sub>4</sub>"x1<sup>1</sup>/<sub>4</sub>"



AS2T Marvel Bianco Dolomite Mosaico Polished  
30x30 - 1<sup>1</sup>/<sub>4</sub>"x1<sup>1</sup>/<sub>4</sub>"

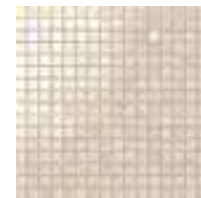

AS3Q Marvel Cream Prestige Mosaico Polished  
30x30 - 1<sup>1</sup>/<sub>4</sub>"x1<sup>1</sup>/<sub>4</sub>"

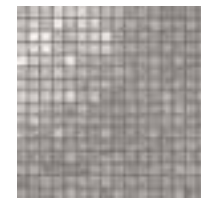

AS3S Marvel Bardiglio Grey Mosaico Polished  
30x30 - 1<sup>1</sup>/<sub>4</sub>"x1<sup>1</sup>/<sub>4</sub>"

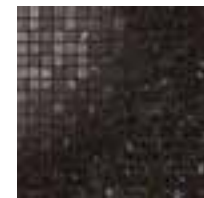

AS3U Marvel Nero Marquina Mosaico Polished  
30x30 - 1<sup>1</sup>/<sub>4</sub>"x1<sup>1</sup>/<sub>4</sub>"

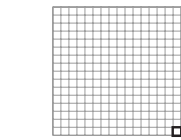

1,7x1,7 cm - 5/<sub>8</sub>"x5/<sub>8</sub>"



AS2J Marvel Carrara Pure Mosaico Esagono Polished  
30x35 - 1<sup>1</sup>/<sub>4</sub>"x13/<sub>4</sub>"



AS2G Marvel Bianco Dolomite Mosaico Esagono Polished  
30x35 - 1<sup>1</sup>/<sub>4</sub>"x13/<sub>4</sub>"



AS2H Marvel Cream Prestige Mosaico Esagono Polished  
30x35 - 1<sup>1</sup>/<sub>4</sub>"x13/<sub>4</sub>"



AS2I Marvel Bardiglio Grey Mosaico Esagono Polished  
30x35 - 1<sup>1</sup>/<sub>4</sub>"x13/<sub>4</sub>"



AS2K Marvel Nero Marquina Mosaico Esagono Polished  
30x35 - 1<sup>1</sup>/<sub>4</sub>"x13/<sub>4</sub>"

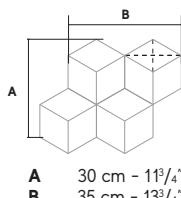

A 30 cm - 1<sup>1</sup>/<sub>4</sub>"  
B 35 cm - 13/<sub>4</sub>"  
10x17 cm - 3<sup>7</sup>/<sub>8</sub>"x6<sup>7</sup>/<sub>8</sub>"



AS4A Marvel Carrara Pure Mosaico Esagono 3D <sup>(1)</sup>  
28,2x35,3 - 11"x14"



AS36 Marvel Bianco Dolomite Mosaico Esagono 3D <sup>(1)</sup>  
28,2x35,3 - 11"x14"



AS38 Marvel Cream Prestige Mosaico Esagono 3D <sup>(1)</sup>  
28,2x35,3 - 11"x14"



AS39 Marvel Bardiglio Grey Mosaico Esagono 3D <sup>(1)</sup>  
28,2x35,3 - 11"x14"



AS4B Marvel Nero Marquina Mosaico Esagono 3D <sup>(1)</sup>  
28,2x35,3 - 11"x14"

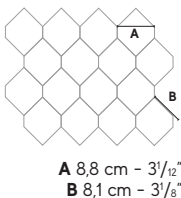

A 8,8 cm - 3/<sub>4</sub>"  
B 8,1 cm - 3/<sub>8</sub>"



AS34 Marvel Carrara Pure Mosaico Polished Burattato <sup>(2)</sup>  
29,8x29,8 - 1<sup>1</sup>/<sub>8</sub>"x1<sup>1</sup>/<sub>8</sub>"



AS31 Marvel Bianco Dolomite Mosaico Polished Burattato <sup>(2)</sup>  
29,8x29,8 - 1<sup>1</sup>/<sub>8</sub>"x1<sup>1</sup>/<sub>8</sub>"



AS32 Marvel Cream Prestige Mosaico Polished Burattato <sup>(2)</sup>  
29,8x29,8 - 1<sup>1</sup>/<sub>8</sub>"x1<sup>1</sup>/<sub>8</sub>"

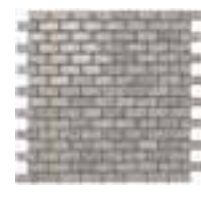

AS33 Marvel Bardiglio Grey Mosaico Polished Burattato <sup>(2)</sup>  
29,8x29,8 - 1<sup>1</sup>/<sub>8</sub>"x1<sup>1</sup>/<sub>8</sub>"



AS35 Marvel Nero Marquina Mosaico Polished Burattato <sup>(2)</sup>  
29,8x29,8 - 1<sup>1</sup>/<sub>8</sub>"x1<sup>1</sup>/<sub>8</sub>"

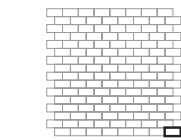

3,5x1,7 cm  
1<sup>1</sup>/<sub>8</sub>"x5/<sub>8</sub>"



AS1V Marvel Carrara Pure Chevron Polished  
22,5x22,9 - 8<sup>7</sup>/<sub>4</sub>"x9"



AS1Q Marvel Bianco Dolomite Chevron Polished  
22,5x22,9 - 8<sup>7</sup>/<sub>4</sub>"x9"



AS1R Marvel Cream Prestige Chevron Polished  
22,5x22,9 - 8<sup>7</sup>/<sub>4</sub>"x9"



AS1U Marvel Bardiglio Grey Chevron Polished  
22,5x22,9 - 8<sup>7</sup>/<sub>4</sub>"x9"



AS1W Marvel Nero Marquina Chevron Polished  
22,5x22,9 - 8<sup>7</sup>/<sub>4</sub>"x9"



AS2F Marvel Chevron Cold Polished  
22,5x22,9 - 8<sup>7</sup>/<sub>4</sub>"x9"  
Carrara Pure + Nero Marquina

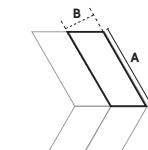

A 26,4 cm - 10<sup>3</sup>/<sub>8</sub>"  
B 9,6 cm - 3<sup>3</sup>/<sub>4</sub>"



AS2L Marvel Mosaico Esagono Geo Cold Polished  
25,4x35,2 - 10"x13<sup>3</sup>/<sub>4</sub>"  
Carrara Pure + Bardiglio Grey + Nero Marquina



AS2M Marvel Mosaico Esagono Geo Warm Polished  
25,4x35,2 - 10"x13<sup>3</sup>/<sub>4</sub>"  
Bianco Dolomite + Cream Prestige + Nero Marquina

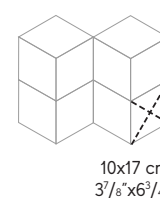

10x17 cm  
3<sup>7</sup>/<sub>8</sub>"x6<sup>7</sup>/<sub>8</sub>"



AMMS Marvel Half Hex Cold Polished  
33x48,3 - 13"x19"  
Carrara Pure + Nero Marquina

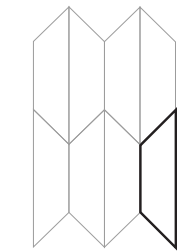

32,1x8 cm  
12<sup>1</sup>/<sub>8</sub>"x3<sup>3</sup>/<sub>8</sub>"

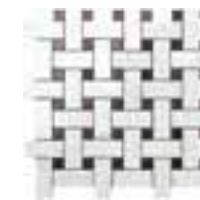

AS2O Marvel Basketweave Cold Polished  
30x30 - 1<sup>1</sup>/<sub>4</sub>"x1<sup>1</sup>/<sub>4</sub>"  
Carrara Pure + Nero Marquina



AS2P Marvel Basketweave Warm Polished  
30x30 - 1<sup>1</sup>/<sub>4</sub>"x1<sup>1</sup>/<sub>4</sub>"  
Cream Prestige + Nero Marquina

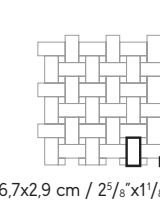

6,7x2,9 cm / 2<sup>5</sup>/<sub>8</sub>"x1<sup>1</sup>/<sub>8</sub>"  
1,7x1,7 cm / 5/<sub>8</sub>"x5/<sub>8</sub>"

<sup>(1)</sup> Multi-thickness mosaic, close joint installation without grouting. - Mosaico multispessore, posa senza stuccatura a giunto nullo. - Mosaïque multi-épaisseur, pose sans mastic avec joint nul. - Mosaik mit verschiedenen Stärken, fugenlose Verlegung ohne Mörtel. Mosaico multiespesor, colocación sin mástico y sin juntas. - Мозаика разной толщины: укладка встык без затирки швов.

<sup>(2)</sup> Tumbled, Irregularities in the edges are not defects but rather features intrinsic to this type of product. - Burattato. Le irregolarità del bordo non sono da considerarsi un difetto ma una caratteristica intrinseca di questa tipologia di prodotto. - Tamisé. Les irrégularités des bords ne doivent pas être considérées comme un défaut mais comme une caractéristique intrinsèque de ce type de produit. - Genarbt. Die unregelmäßigen Kanten sind nicht als Fehler zu betrachten; sie sind ein für dieses Produkt charakteristisches Merkmal. - Tamboreado. Las irregularidades de los bordes no deben considerarse un defecto, sino una característica intrínseca de este tipo de productos. - Галтованная мозаика. Неровности граней являются не дефектом, а неотъемлемой характеристикой данного вида изделий.

The decoration can only be laid on the wall. - Il decoro si può posare solo a rivestimento - Décor uniquement mural - Das Dekor kann nur an der Wand verlegt werden. La decoración se puede colocar únicamente en paredes - Декор может быть уложен только на стену.

# Marvel Stone

## Wall Tiles

### SHINY SURFACE



± 8,5 mm

50x120 cm - 19<sup>5</sup>/<sub>8</sub>"x47<sup>1</sup>/<sub>4</sub>"

- A4S3 Marvel Carrara Pure
- A4S4 Marvel Bianco Dolomite
- A4S5 Marvel Cream Prestige
- A4S6 Marvel Bardiglio Grey
- A4S7 Marvel Nero Marquina

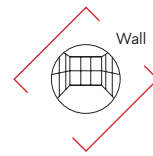

± 8,5 mm

40x80 cm - 15<sup>3</sup>/<sub>4</sub>"x31<sup>1</sup>/<sub>2</sub>"

- 9MSF Marvel Carrara Pure
- 9MSB Marvel Bianco Dolomite
- 9MSI Marvel Cream Prestige
- 9MSD Marvel Bardiglio Grey
- 9MSM Marvel Nero Marquina

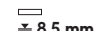

± 8,5 mm

8x31,5 cm - 3<sup>1</sup>/<sub>8</sub>"x12<sup>3</sup>/<sub>8</sub>"

- AZA2 Carrara Pure Brick



CARRARA PURE



BIANCO DOLOMITE



CREAM PRESTIGE



BARDIGLIO GREY



NERO MARQUINA



V2 Slight Variation

### DECOR RANGE

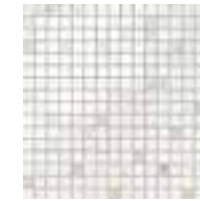

9MQC Carrara Pure Mosaic Q  
30,5x30,5 - 12"x12"

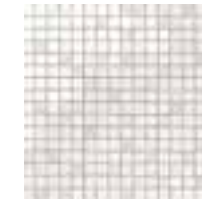

9MQB Bianco Dolomite Mosaic Q  
30,5x30,5 - 12"x12"



9MQE Cream Prestige Mosaic Q  
30,5x30,5 - 12"x12"



9MQA Bardiglio Grey Mosaic Q  
30,5x30,5 - 12"x12"



9MQN Nero Marquina Mosaic Q  
30,5x30,5 - 12"x12"

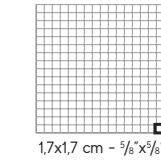

1,7x1,7 cm - 5<sup>5</sup>/<sub>8</sub>"x5<sup>5</sup>/<sub>8</sub>"



9SHC Carrara Pure Herringbone Wall  
30,5x30 - 12"x11<sup>1</sup>/<sub>4</sub>"



9SHD Bianco Dolomite Herringbone Wall  
30,5x30 - 12"x11<sup>1</sup>/<sub>4</sub>"



9SHE Cream Prestige Herringbone Wall  
30,5x30 - 12"x11<sup>1</sup>/<sub>4</sub>"



9SHB Bardiglio Grey Herringbone Wall  
30,5x30 - 12"x11<sup>1</sup>/<sub>4</sub>"



9SHN Nero Marquina Herringbone Wall  
30,5x30 - 12"x11<sup>1</sup>/<sub>4</sub>"

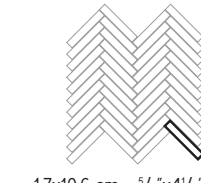

1,7x10,6 cm - 5<sup>1</sup>/<sub>8</sub>"x4<sup>1</sup>/<sub>8</sub>"



9STA Carrara Pure Twist  
30,5x30,5 - 12"x12"



9STD Bianco Dolomite Twist  
30,5x30,5 - 12"x12"



9STE Cream Prestige Twist  
30,5x30,5 - 12"x12"



9STB Bardiglio Grey Twist  
30,5x30,5 - 12"x12"



9STN Nero Marquina Twist  
30,5x30,5 - 12"x12"

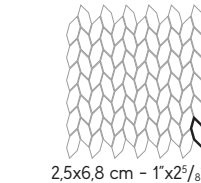

2,5x6,8 cm - 1"x2<sup>2</sup>/<sub>8</sub>"



9SCA Carrara Pure Chevron Wall  
30,5x25 - 12"x9<sup>7</sup>/<sub>8</sub>"



9SCD Bianco Dolomite Chevron Wall  
30,5x25 - 12"x9<sup>7</sup>/<sub>8</sub>"



9SCN Nero Marquina Chevron Wall  
30,5x25 - 12"x9<sup>7</sup>/<sub>8</sub>"



9SCL Chevron Cold Wall  
30,5x25 - 12"x9<sup>7</sup>/<sub>8</sub>"  
Carrara Pure + Nero Marquina



9SCW Chevron Warm Wall  
30,5x25 - 12"x9<sup>7</sup>/<sub>8</sub>"  
Bianco Dolomite + Nero Marquina



9SCM Chevron Mix Wall  
30,5x25 - 12"x9<sup>7</sup>/<sub>8</sub>"  
Carrara Pure + Bardiglio Grey + Nero Marquina

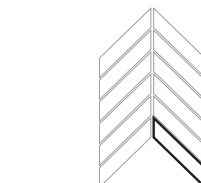

17,5x3,4 cm - 6<sup>7</sup>/<sub>8</sub>"x1<sup>1</sup>/<sub>8</sub>"



ASEK Marvel Greca Gold <sup>(1)</sup>  
7,8x30,5 - 3<sup>1</sup>/<sub>8</sub>"x12"



ASEM Marvel Greca A.E. <sup>(1)</sup>  
7,8x12 - 3<sup>1</sup>/<sub>8</sub>"x1<sup>1</sup>/<sub>2</sub>"

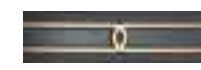

LVGB Marvel Gold Black <sup>(1)</sup>  
7,8x30,5 - 3<sup>1</sup>/<sub>8</sub>"x12"



AVGB Marvel Gold Black A.E. <sup>(1)</sup>  
7,8x12 - 3<sup>1</sup>/<sub>8</sub>"x1<sup>1</sup>/<sub>2</sub>"



LVGW Marvel Gold White <sup>(1)</sup>  
7,8x30,5 - 3<sup>1</sup>/<sub>8</sub>"x12"



AVGW Marvel Gold White A.E. <sup>(1)</sup>  
7,8x12 - 3<sup>1</sup>/<sub>8</sub>"x1<sup>1</sup>/<sub>2</sub>"

<sup>(1)</sup> Contains gold. The use of a common mild detergent is recommended. Avoid using acidic or alkaline products, waxes, steel wool or abrasives. - Parti in oro. Si consiglia l'utilizzo di un comune detergente neutro. Evitare l'utilizzo di prodotti acidi o alcalini, ceranti, pagliette di metallo o abrasive. - Parties dorées. Nous vous conseillons d'utiliser des détergents neutres courants. Éviter l'utilisation de cires et de produits acides ou alcalins, ainsi que les pailles métalliques ou abrasives. - Teile aus Gold. Es empfiehlt sich, ein haushaltsübliches, neutrales Reinigungsmittel zu verwenden. Saure oder alkalische Produkte, Wachs sowie Metallwolle- bzw. Scheuerschwämme sind zu vermeiden. - Partes doradas. Recomendamos utilizar un detergente neutro común. Hay que evitar el uso de productos ácidos o alcalinos, ceras y estropajos de metal o abrasivos. - Золотые детали. Рекомендуется чистить обычным нейтральным моющим средством. Не рекомендуется использовать кислотные, щелочные, восковые средства, а также металлические мочалки.

INDEX



A COMPLETE PRODUCT SYSTEM



PRODUCT FINDER



SURFACE RANGE



COMPANY



COLLECTIONS



3D WALL  
CONCRETE & RESIN LOOK  
METAL LOOK  
MARBLE LOOK  
STONE LOOK  
WOOD LOOK

LARGE SIZES



SLABS FOR COUNTERTOPS & FURNITURE



SINKS & BATHROOM FURNISHING



FACADES



TECHNICAL SPECIFICATIONS



# Marvel Travertine

In collaboration with **HBA**



© Ceramiche Atlas Concorde



© Ceramiche Atlas Concorde



© Ceramiche Atlas Concorde

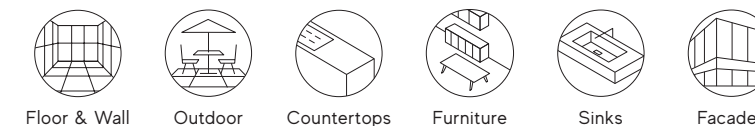

## Porcelain Tiles RECTIFIED MONOCALIBER

### VEIN CUT

Sizes	Thickness	Surface finish
120x278 cm - 47 1/4" x 109 1/2"	± 6 mm	Matte R9 A
120x240 cm - 47 1/4" x 94 1/2"	± 9 mm	Matte R10 B
60x120 cm - 23 5/8" x 47 1/4"	± 9 mm	Matte Sensitech R10 B

### LARGE SIZES p. 356

### OUTDOOR AND WET AREAS

60x120 cm - 23 5/8" x 47 1/4"	± 9 mm	Grip R11 C
60x120 cm - 23 5/8" x 47 1/4"	± 20 mm	Outdoor R11 C

### atlasPLAN

### SLABS FOR COUNTERTOPS & FURNITURE

162x324 cm - 63 3/4" x 127 1/2" NON-RECTIFIED	± 6-12 mm	Hammered
--	-----------	----------

### CROSS CUT

Sizes	Thickness	Surface finish
120x120 cm - 47 1/4" x 47 1/4"	± 9 mm	Matte Sensitech R10 B
60x120 cm - 23 5/8" x 47 1/4"	± 9 mm	Matte Sensitech R10 B
60x60 cm - 23 5/8" x 23 5/8"	± 9 mm	Matte Sensitech R10 B

### OUTDOOR AND WET AREAS

60x120 cm - 23 5/8" x 47 1/4"	± 9 mm	Grip R11 C
-------------------------------	--------	------------

INDEX



A COMPLETE PRODUCT SYSTEM



PRODUCT FINDER



SURFACE RANGE



COMPANY



COLLECTIONS



3D WALL  
CONCRETE & RESIN LOOK  
METAL LOOK  
MARBLE LOOK  
STONE LOOK  
WOOD LOOK

LARGE SIZES



SLABS FOR COUNTERTOPS & FURNITURE



SINKS & BATHROOM FURNISHING



FACADES



TECHNICAL SPECIFICATIONS



# Marvel Travertine



Matte ± 6 mm



Matte ± 9 mm  
Matte Sensitech (S) ± 9 mm  
Grip ± 9 mm  
Outdoor ± 20 mm



R9 Matte ± 6 mm  
R10 B Matte ± 9 mm  
R10 B Matte Sensitech (S) ± 9 mm  
R11 C Grip ± 9 mm  
R11 C Outdoor ± 20 mm



V3 Moderate Variation

## Porcelain Tiles

### Vein Cut

#### MATTE SURFACE

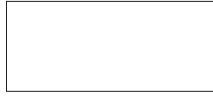

± 6 mm

**120x278 cm** - 47<sup>1</sup>/<sub>4</sub>"x109<sup>1</sup>/<sub>2</sub>"  
AFS1 Marvel White Vein  
AFS2 Marvel Sand Vein  
AFS3 Marvel Pearl Vein

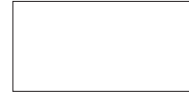

± 9 mm

**120x240 cm** - 47<sup>1</sup>/<sub>4</sub>"x94<sup>1</sup>/<sub>2</sub>"  
AFT7 Marvel White Vein  
AFT8 Marvel Sand Vein  
AFT9 Marvel Pearl Vein



± 9 mm

**60x120 cm** - 23<sup>5</sup>/<sub>8</sub>"x47<sup>1</sup>/<sub>4</sub>"  
A8UW Marvel White Vein  
AFUA Marvel Sand Vein  
AFUB Marvel Pearl Vein



#### GRIP SURFACE



± 9 mm

**60x120 cm** - 23<sup>5</sup>/<sub>8</sub>"x47<sup>1</sup>/<sub>4</sub>"  
AFUC Marvel White Vein Grip  
AFUD Marvel Sand Vein Grip  
AFUE Marvel Pearl Vein Grip



± 20 mm

**60x120 cm** - 23<sup>5</sup>/<sub>8</sub>"x47<sup>1</sup>/<sub>4</sub>"  
AGE7 Marvel White Vein 20 mm  
AGE8 Marvel Sand Vein 20 mm  
AGE9 Marvel Pearl Vein 20 mm



### Cross Cut

#### MATTE SURFACE



± 9 mm

**120x120 cm** - 47<sup>1</sup>/<sub>4</sub>"x47<sup>1</sup>/<sub>4</sub>"  
A8WU Marvel White Cross  
A8WV Marvel Sand Cross  
A8WW Marvel Pearl Cross



± 9 mm

**60x120 cm** - 23<sup>5</sup>/<sub>8</sub>"x47<sup>1</sup>/<sub>4</sub>"  
A8UZ Marvel White Cross  
AFUF Marvel Sand Cross  
AFUG Marvel Pearl Cross



± 9 mm

**60x60 cm** - 23<sup>5</sup>/<sub>8</sub>"x23<sup>5</sup>/<sub>8</sub>"  
AFUK Marvel White Cross  
AFUL Marvel Sand Cross  
AFUM Marvel Pearl Cross



#### GRIP SURFACE



± 9 mm

**60x120 cm** - 23<sup>5</sup>/<sub>8</sub>"x47<sup>1</sup>/<sub>4</sub>"  
AFUH Marvel White Cross Grip  
AFUI Marvel Sand Cross Grip  
AFUJ Marvel Pearl Cross Grip



#### COMPLETE YOUR PROJECT



Countertops  
P.402  
162x324 cm  
NON-RECTIFIED



Furniture  
P.356



Sinks  
P.412



Facades  
P.436



WHITE VEIN CUT



WHITE CROSS CUT



SAND VEIN CUT



SAND CROSS CUT

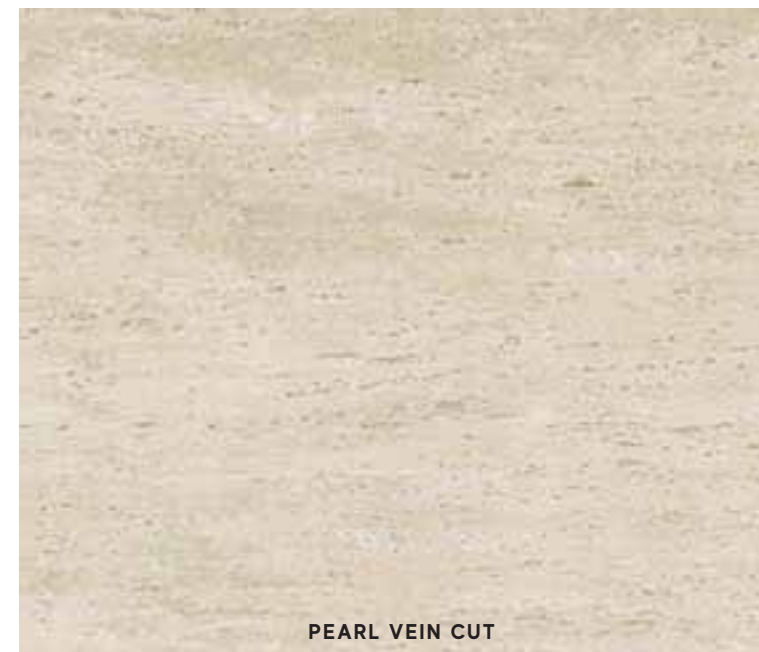

PEARL VEIN CUT



PEARL CROSS CUT

INDEX



A COMPLETE PRODUCT SYSTEM >

PRODUCT FINDER >

SURFACE RANGE >

COMPANY >

COLLECTIONS >

3D WALL  
CONCRETE & RESIN LOOK  
METAL LOOK  
MARBLE LOOK  
STONE LOOK  
WOOD LOOK

LARGE SIZES >

SLABS FOR COUNTERTOPS & FURNITURE >

SINKS & BATHROOM FURNISHING >

FACADES >

TECHNICAL SPECIFICATIONS >

# Marvel Travertine

## Porcelain Tiles

Decors designed by



### DECOR RANGE



AF9S Marvel Travertine White Diamond<sup>®</sup>  
60x60 cm - 23<sup>5</sup>/<sub>8</sub>"x23<sup>5</sup>/<sub>8</sub>"  
Cross Cut



AF9T Marvel Travertine Sand Diamond<sup>®</sup>  
60x60 cm - 23<sup>5</sup>/<sub>8</sub>"x23<sup>5</sup>/<sub>8</sub>"  
Cross Cut



AF9U Marvel Travertine Pearl Diamond<sup>®</sup>  
60x60 cm - 23<sup>5</sup>/<sub>8</sub>"x23<sup>5</sup>/<sub>8</sub>"  
Cross Cut



AF9P Marvel Travertine White Cross Chiselled Urban Grid<sup>®</sup>  
30x60 cm - 11<sup>1</sup>/<sub>4</sub>"x23<sup>5</sup>/<sub>8</sub>"  
Cross Cut



AF9Q Marvel Travertine Sand Cross Chiselled Urban Grid<sup>®</sup>  
30x60 cm - 11<sup>1</sup>/<sub>4</sub>"x23<sup>5</sup>/<sub>8</sub>"  
Cross Cut



AF9R Marvel Travertine Pearl Cross Chiselled Urban Grid<sup>®</sup>  
30x60 cm - 11<sup>1</sup>/<sub>4</sub>"x23<sup>5</sup>/<sub>8</sub>"  
Cross Cut

**For best results it is recommended to follow one of the following laying patterns.** - Per un risultato estetico ottimale si consiglia di seguire uno dei seguenti schemi di posa. - Nous vous invitons à respecter un des schémas de pose suivants pour un résultat esthétique optimal. - Für ein optisch optimales Resultat empfehlen wir, eines der nachstehenden Verlegemuster zu befolgen. - Para obtener un mejor resultado estético, es aconsejable seguir uno de los siguientes esquemas de colocación. - Для достижения наилучшего эстетического результата рекомендуется использовать одну из следующих схем укладки.

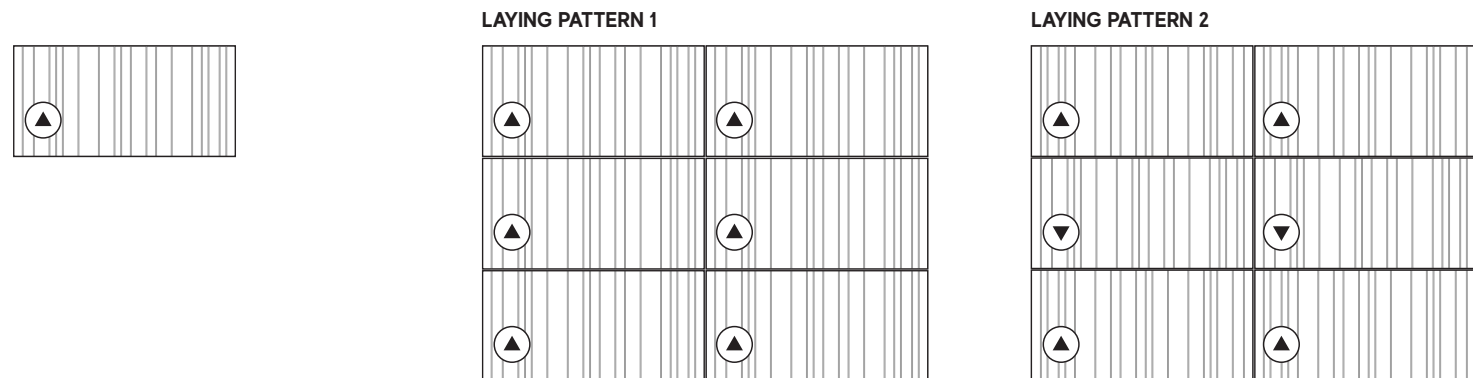

<sup>®</sup> Application of decorative materials. The use of a common mild detergent is recommended. Avoid using acidic or alkaline products, waxes, steel wool, or abrasives. - Applicazione di materie decorative. Si consiglia l'utilizzo di un comune detergente neutro. Evitare l'utilizzo di prodotti acidi o alcalini, ceranti e pagliette di metallo o abrasive. - Application de matériaux décoratifs. Nous conseillons l'emploi de détergents neutres courants. Éviter l'utilisation de cires et de produits acides ou alcalins, ainsi que les pâilles métalliques ou abrasives. - Dekorationsmaterial. Es empfiehlt sich, ein haushaltsübliches, neutrales Reinigungsmittel zu verwenden. Saure oder alkalische Produkte, Wachs sowie Stahlwolle- bzw. Scheuerschwämme sind zu vermeiden. - Aplicación de materiales decorativos. Recomendamos utilizar un detergente neutro común. Hay que evitar el uso de productos ácidos o alcalinos, ceras y estropajos de metal o abrasivos. - Применение декоративных материалов. Рекомендуется чистить обычным нейтральным моющим средством. Не рекомендуется использовать кислотные, щелочные, восковые средства, а также металлические мочалки. - Mosaico inciso, per risultato ottimale si consiglia di stuccare completamente le incisioni. - Mosaïque gravée, pour de meilleurs résultats, il est recommandé de remplir complètement les gravures. - Graviertes Mosaik; für ein optimales Resultat sollten die Gravuren vollständig verspachtelt werden. - Mosaico grabado, para obtener los mejores resultados se recomienda enmasillar el grabado en su totalidad. - Высеченная мозаика. Для оптимального результата рекомендуется полностью заделывать углубления затиркой.



© Ceramiche Atlas Concorde



© Ceramiche Atlas Concorde

INDEX



A COMPLETE PRODUCT SYSTEM



PRODUCT FINDER



SURFACE RANGE



COMPANY



COLLECTIONS



3D WALL  
CONCRETE & RESIN LOOK  
METAL LOOK  
MARBLE LOOK  
STONE LOOK  
WOOD LOOK

LARGE SIZES



SLABS FOR COUNTERTOPS & FURNITURE



SINKS & BATHROOM FURNISHING



FACADES



TECHNICAL SPECIFICATIONS



# Marvel Travertine

## Porcelain Tiles

### DECOR RANGE



AF9J Marvel Travertine White  
Mosaico Origami  
28x41,2 cm - 11"x16<sup>1</sup>/<sub>4</sub>"



AF9K Marvel Travertine Sand  
Mosaico Origami  
28x41,2 cm - 11"x16<sup>1</sup>/<sub>4</sub>"



AF9L Marvel Travertine Pearl  
Mosaico Origami  
28x41,2 cm - 11"x16<sup>1</sup>/<sub>4</sub>"



AF9M Marvel Travertine White  
Mosaico Basketweave  
35x46,8 cm - 13<sup>3</sup>/<sub>4</sub>"x18<sup>3</sup>/<sub>4</sub>"



AF9N Marvel Travertine Sand  
Mosaico Basketweave  
35x46,8 cm - 13<sup>3</sup>/<sub>4</sub>"x18<sup>3</sup>/<sub>4</sub>"



AF9O Marvel Travertine Pearl  
Mosaico Basketweave  
35x46,8 cm - 13<sup>3</sup>/<sub>4</sub>"x18<sup>3</sup>/<sub>4</sub>"



AF9G Marvel Travertine White  
Mosaico Tessellation  
22x26 cm - 8<sup>5</sup>/<sub>8</sub>"x10<sup>1</sup>/<sub>4</sub>"



AF9H Marvel Travertine Sand  
Mosaico Tessellation  
22x26 cm - 8<sup>5</sup>/<sub>8</sub>"x10<sup>1</sup>/<sub>4</sub>"



AF9I Marvel Travertine Pearl  
Mosaico Tessellation  
22x26 cm - 8<sup>5</sup>/<sub>8</sub>"x10<sup>1</sup>/<sub>4</sub>"

Decors designed by  
**HBA**

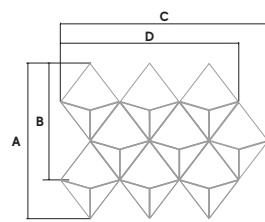

- Vein Cut
- A** 38,81 cm - 15<sup>1</sup>/<sub>4</sub>"
- B** 28 cm - 11"
- C** 48,05 cm - 18<sup>7</sup>/<sub>8</sub>"
- D** 41,2 cm - 16<sup>1</sup>/<sub>4</sub>"

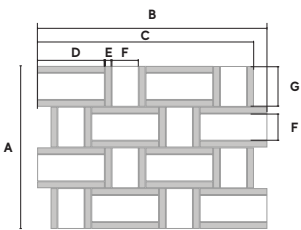

- Vein Cut
- Cross Cut
- A** 35 cm - 13<sup>3</sup>/<sub>4</sub>"
- B** 49,8 cm - 19<sup>5</sup>/<sub>8</sub>"
- C** 46,8 cm - 18<sup>3</sup>/<sub>4</sub>"
- D** 14,5 cm - 5<sup>7</sup>/<sub>8</sub>"
- E** 1,3 cm - 1/2"
- F** 5,7 cm - 2<sup>1</sup>/<sub>4</sub>"
- G** 8,7 cm - 3<sup>3</sup>/<sub>8</sub>"

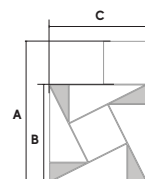

- Vein Cut
- Cross Cut
- A** 31,6 cm - 12<sup>1</sup>/<sub>2</sub>"
- B** 26,2 cm - 10<sup>1</sup>/<sub>4</sub>"
- C** 22 cm - 8<sup>5</sup>/<sub>8</sub>"



© Ceramiche Atlas Concorde

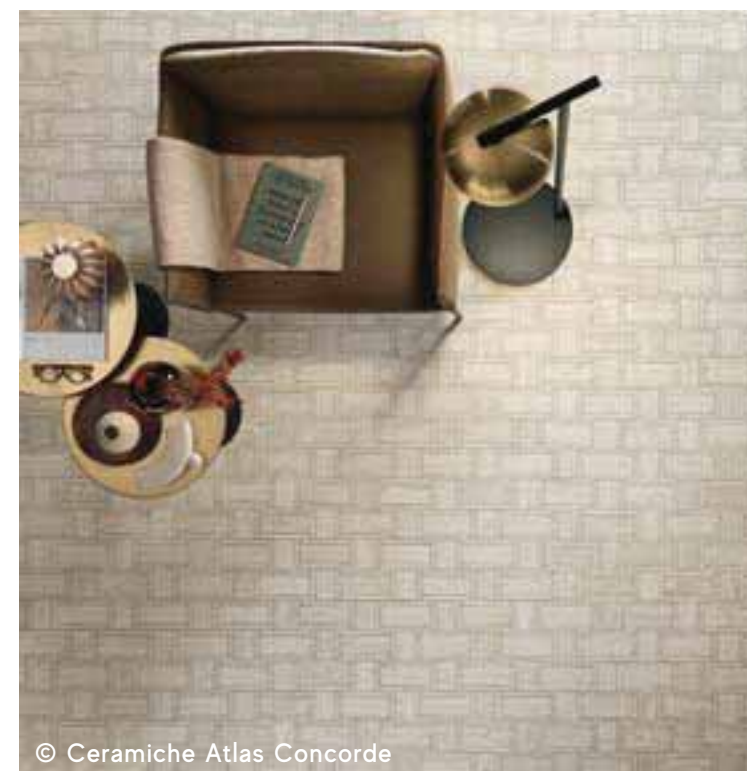

© Ceramiche Atlas Concorde



© Ceramiche Atlas Concorde

### TRIM TILES p. 352

#### Battiscopa

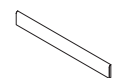

Digitale 7,2x120 cm  
2<sup>1</sup>/<sub>8</sub>"x47<sup>1</sup>/<sub>4</sub>"

Matte

- White Vein Cut AF7B
- Sand Vein Cut AF7C
- Pearl Vein Cut AF7D
- White Cross Cut AF7E
- Sand Cross Cut AF7F
- Pearl Cross Cut AF7G

#### Gradino \*



30x120 cm  
11<sup>3</sup>/<sub>4</sub>"x47<sup>1</sup>/<sub>4</sub>"

Matte

- AF7T
- AF7U
- AF7V
- AF7W
- AF7X
- AF7Y

#### Scalino \*

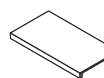

33x120 cm  
13"x47<sup>1</sup>/<sub>4</sub>"

Matte

- AF7Z
- AF8A
- AF8B
- AF8C
- AF8D
- AF8E

#### Scalino Ang.\*

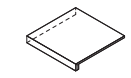

33x33 cm  
13"x13"

Matte

- |      |      |
|------|------|
| DX   | SX   |
| AF9V | AF9Y |
| AF9W | AF9Z |
| AF9X | AF92 |
| AGEQ |      |
| AGET |      |
| AGEU |      |

#### Corner \*



1x120 cm  
3<sup>1</sup>/<sub>8</sub>"x47<sup>1</sup>/<sub>4</sub>"

Matte

- AGE2
- AGE3
- AGE4
- 
- 
- 

#### Battiscopa Sag. Scala \*



7,2x30 cm  
2<sup>1</sup>/<sub>8</sub>"x11<sup>1</sup>/<sub>4</sub>"

Matte

- |      |      |
|------|------|
| DX   | SX   |
| AF7K | AF7H |
| AF7L | AF7I |
| AF7M | AF7J |
| AF7Q | AF7N |
| AF7R | AF7O |
| AF7S | AF7P |

#### Elemento L



33x120 H. 4 cm  
13"x47<sup>1</sup>/<sub>4</sub>" H.1<sup>1</sup>/<sub>4</sub>"

Grip

- AGEV
- AGEW
- AGEX
- AGEY
- AGEZ
- AGEØ

\* These parts are supplied to order - I pezzi sono disponibili su ordinazione - Les pièces sont disponibles sur commande - Die Teile sind auf Bestellung lieferbar - Las piezas se hacen por encargo - Изготавливаются на заказ

# Marvel X



© Ceramiche Atlas Concorde



© Ceramiche Atlas Concorde



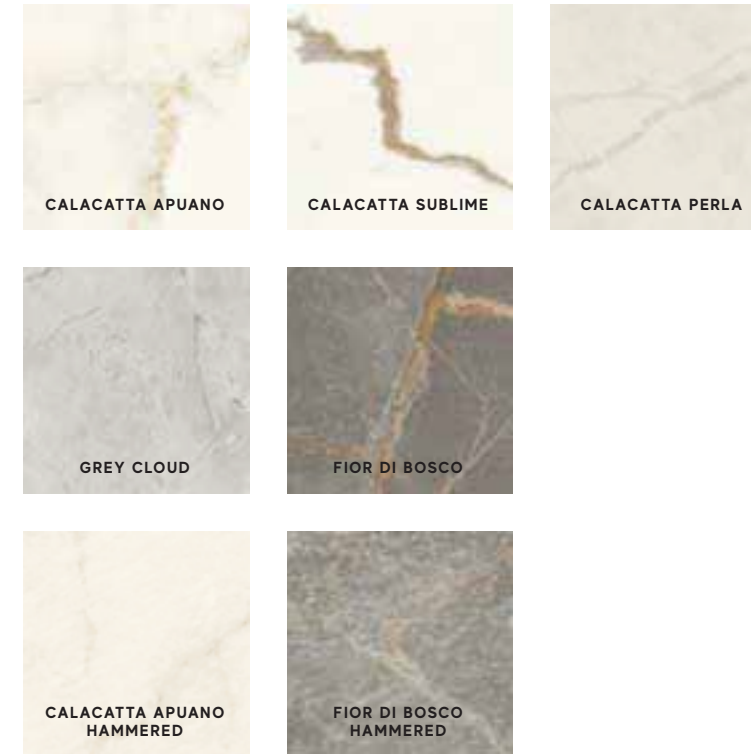
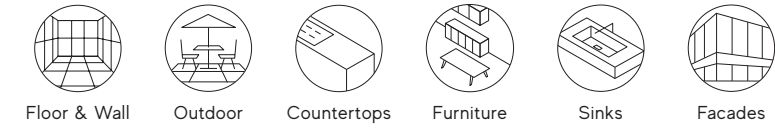

© Ceramiche Atlas Concorde





**Porcelain Tiles** RECTIFIED MONOCALIBER

Sizes	Thickness	Surface finish
120x278 cm - 47 <sup>1</sup> / <sub>4</sub> "x109 <sup>1</sup> / <sub>2</sub> "	± 6 mm	Polished   Silk
120x240 cm - 47 <sup>1</sup> / <sub>4</sub> "x94 <sup>1</sup> / <sub>2</sub> "	± 9 mm	Polished
120x120 cm - 47 <sup>1</sup> / <sub>4</sub> "x47 <sup>1</sup> / <sub>4</sub> "	± 9 mm	Polished   Silk
75x150 cm - 29 <sup>1</sup> / <sub>2</sub> "x59"	± 9 mm	Polished   Silk
75x75 cm - 29 <sup>1</sup> / <sub>2</sub> "x29 <sup>1</sup> / <sub>2</sub> "	± 9 mm	Polished   Silk
60x120 cm - 23 <sup>3</sup> / <sub>8</sub> "x47 <sup>1</sup> / <sub>4</sub> "	± 9 mm	Polished   Matte <b>Sensitech R10 B</b>
60x60 cm - 23 <sup>3</sup> / <sub>8</sub> "x23 <sup>3</sup> / <sub>8</sub> "	± 9 mm	Polished   Matte <b>Sensitech R10 B</b>
30x60 cm - 11 <sup>1</sup> / <sub>4</sub> "x23 <sup>3</sup> / <sub>8</sub> "	± 9 mm	Polished   Matte <b>Sensitech R10 B</b>
<b>LARGE SIZES</b> P. 356		
<b>OUTDOOR AND WET AREAS</b>		
60x120 cm - 23 <sup>3</sup> / <sub>8</sub> "x47 <sup>1</sup> / <sub>4</sub> "	± 20 mm	Outdoor <b>R11 C</b>
<b>atlas<sup>PLAN</sup></b>		
<b>SLABS FOR COUNTERTOPS &amp; FURNITURE</b>		
162x324 cm - 63 <sup>3</sup> / <sub>4</sub> "x127 <sup>1</sup> / <sub>2</sub> " NON-RECTIFIED	± 12 mm	Polished   Silk

INDEX 

A COMPLETE PRODUCT SYSTEM 

PRODUCT FINDER 

SURFACE RANGE 

COMPANY 

COLLECTIONS 

- 3D WALL
- CONCRETE & RESIN LOOK
- METAL LOOK
- MARBLE LOOK
- STONE LOOK
- WOOD LOOK

LARGE SIZES 

SLABS FOR COUNTERTOPS & FURNITURE 

SINKS & BATHROOM FURNISHING 

FACADES 

TECHNICAL SPECIFICATIONS 



# Marvel X

## Porcelain Tiles

### POLISHED SURFACE <sup>(1)</sup>



± 6 mm

120x278 cm - 47 1/4"x109 1/2"

AFUS Marvel Calacatta Apuano Polished  
 AFUT Marvel Calacatta Sublime Polished  
 AFWN Marvel Calacatta Sublime 120x278 Kit Endless <sup>(2) (3)</sup>  
 AFUU Marvel Calacatta Perla Polished  
 AFUV Marvel Grey Cloud Polished  
 AFUW Marvel Fior di Bosco Polished



± 9 mm

120x240 cm - 47 1/4"x94 1/2"

AFU2 Marvel Calacatta Apuano Polished  
 AFU3 Marvel Calacatta Sublime Polished  
 AFU4 Marvel Calacatta Perla Polished  
 AFU5 Marvel Grey Cloud Polished  
 AFU6 Marvel Fior di Bosco Polished



± 9 mm

120x120 cm - 47 1/4"x47 1/4"

AFU7 Marvel Calacatta Apuano Polished  
 A8YT Marvel Calacatta Sublime Polished  
 AFU8 Marvel Calacatta Perla Polished  
 AFU9 Marvel Grey Cloud Polished  
 AFVA Marvel Fior di Bosco Polished



± 9 mm

60x120 cm - 23 5/8"x47 1/4"

A8Z2 Marvel Calacatta Apuano Polished  
 A8Z3 Marvel Calacatta Sublime Polished  
 A8Z4 Marvel Calacatta Perla Polished  
 A8Z5 Marvel Grey Cloud Polished  
 A8Z6 Marvel Fior di Bosco Polished



± 9 mm

60x60 cm - 23 5/8"x23 5/8"

AFVY Marvel Calacatta Apuano Polished  
 AFVZ Marvel Calacatta Sublime Polished  
 AFVØ Marvel Calacatta Perla Polished  
 AFV1 Marvel Grey Cloud Polished  
 AFV2 Marvel Fior di Bosco Polished



± 9 mm

30x60 cm - 11 3/4"x23 5/8"

AFV8 Marvel Calacatta Apuano Polished  
 AFV9 Marvel Calacatta Sublime Polished  
 AFWA Marvel Calacatta Perla Polished  
 AFWB Marvel Grey Cloud Polished  
 AFWC Marvel Fior di Bosco Polished



± 9 mm

75x150 cm - 29 1/2"x59"

AFVB Marvel Calacatta Apuano Polished  
 AFVC Marvel Calacatta Sublime Polished  
 AFVD Marvel Calacatta Perla Polished  
 AEKQ Marvel Grey Cloud Polished  
 AEKR Marvel Fior di Bosco Polished



± 9 mm

75x75 cm - 29 1/2"x29 1/2"

AFVE Marvel Calacatta Apuano Polished  
 AFVF Marvel Calacatta Sublime Polished  
 AFVG Marvel Calacatta Perla Polished  
 AFVH Marvel Grey Cloud Polished  
 AFVI Marvel Fior di Bosco Polished

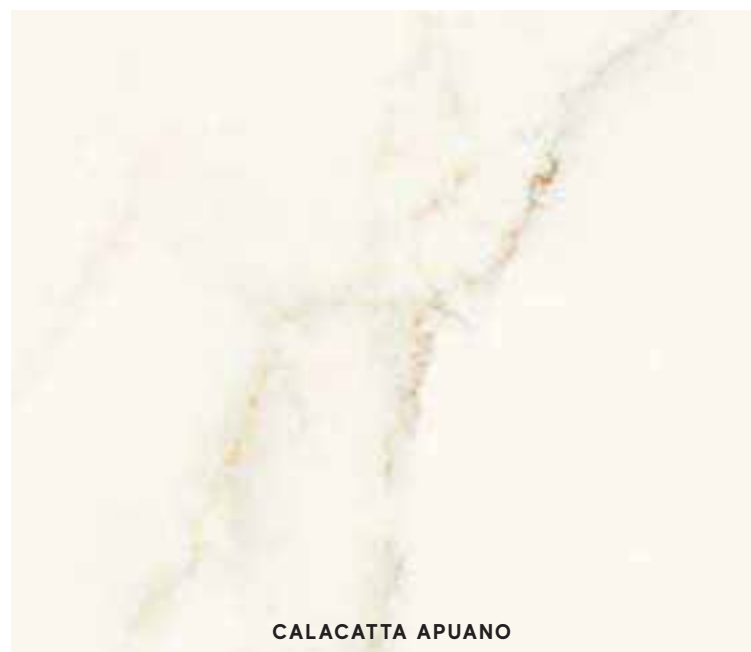

CALACATTA APUANO

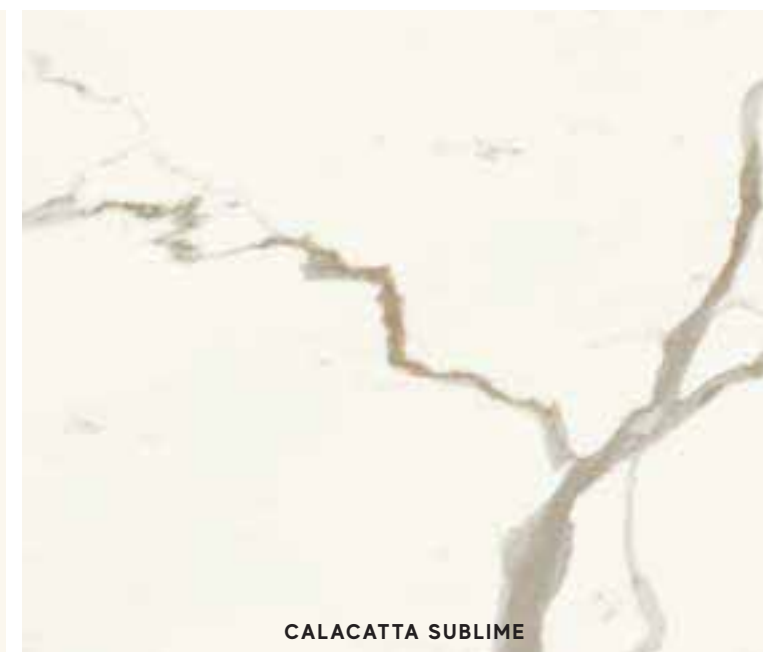

CALACATTA SUBLIME



CALACATTA PERLA



GREY CLOUD



FIOR DI BOSCO

<sup>(1)</sup> The glossy polished finish is suitable for residential or low-traffic commercial floors, where no anti-slip performance is required, and for walls. The polished glossy surface finish, surprisingly brilliant and bright, features slight irregularities typical of natural marble. The extraordinary brilliance and the easy cleaning of the surface are the result of in-depth research aimed at guaranteeing its durability over time. If the product is in direct contact with the outdoors, provide devices for absorbing moisture and dirt to prevent scratches. - La finitura lappata lucida è indicata per pavimenti residenziali o commerciali poco sollecitati, laddove non siano richieste prestazioni antiscivolo, e per rivestimenti. La finitura lappata lucida offre una superficie sorprendentemente brillante e specchiante, con lievi irregolarità tipiche dei marmi naturali. La straordinaria lucentezza e l'elevata pulibilità della superficie sono frutto di studi approfonditi e accurate ricerche tecniche volte a garantire la persistenza nel tempo. Se il prodotto è a diretto contatto con l'esterno, prevedere dei dispositivi di assorbimento dell'umidità e della sporcizia per prevenire la formazione di graffi.

<sup>(2) (3)</sup> Please read the notes at page 401

### COMPLETE YOUR PROJECT



Countertops  
P. 402  
162x324 cm  
NON-RECTIFIED



Furniture  
P. 356



Sinks  
P. 412

INDEX



A COMPLETE PRODUCT SYSTEM



PRODUCT FINDER



SURFACE RANGE



COMPANY



COLLECTIONS



3D WALL  
 CONCRETE & RESIN LOOK  
 METAL LOOK  
 MARBLE LOOK  
 STONE LOOK  
 WOOD LOOK

LARGE SIZES



SLABS FOR COUNTERTOPS & FURNITURE



SINKS & BATHROOM FURNISHING



FACADES



TECHNICAL SPECIFICATIONS



# Marvel X

## Porcelain Tiles



Silk ± 6 mm  
Silk ± 9 mm



Matte Sensitech (S) ± 9 mm  
Outdoor ± 20 mm



R10 B Matte Sensitech (S) ± 9 mm  
R11 C Outdoor ± 20 mm



V2 Slight Variation  
Calacatta Apuano



V3 Moderate Variation  
Calacatta Sublime,  
Calacatta Perla,  
Grey Cloud,  
Fior di Bosco



### SILK SURFACE (1)



± 6 mm

120x278 cm - 47 1/4" x 109 1/2"

AFUX Marvel Calacatta Apuano Silk

AFUY Marvel Calacatta Sublime Silk

AFWO Marvel Calacatta Sublime 120x278 Silk Kit Endless (2) (3)

AFUZ Marvel Calacatta Perla Silk

AFUØ Marvel Grey Cloud Silk

AFU1 Marvel Fior di Bosco Silk



± 9 mm

120x120 cm - 47 1/4" x 47 1/4"

AFVJ Marvel Calacatta Apuano Silk

AFVK Marvel Calacatta Sublime Silk

AFVL Marvel Calacatta Perla Silk

AFVM Marvel Grey Cloud Silk

AFVN Marvel Fior di Bosco Silk



± 9 mm

75x150 cm - 29 1/2" x 59"

AFVO Marvel Calacatta Apuano Silk

AFVP Marvel Calacatta Sublime Silk

AFVQ Marvel Calacatta Perla Silk

AFVR Marvel Grey Cloud Silk

AFVS Marvel Fior di Bosco Silk



± 9 mm

75x75 cm - 29 1/2" x 29 1/2"

AFVT Marvel Calacatta Apuano Silk

AFVU Marvel Calacatta Sublime Silk

AFVV Marvel Calacatta Perla Silk

AFVW Marvel Grey Cloud Silk

AFVX Marvel Fior di Bosco Silk

### MATTE SURFACE

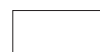

(S)

± 9 mm

60x120 cm - 23 5/8" x 47 1/4"

AFM2 Marvel Calacatta Apuano Hammered

AFM3 Marvel Fior di Bosco Hammered

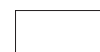

(S)

± 9 mm

60x120 cm - 23 5/8" x 47 1/4"

AFWI Marvel Calacatta Apuano

AFWJ Marvel Calacatta Sublime

AFWK Marvel Calacatta Perla

AFWL Marvel Grey Cloud

AFWM Marvel Fior di Bosco



(S)

± 9 mm

60x60 cm - 23 5/8" x 23 5/8"

AFV3 Marvel Calacatta Apuano

AFV4 Marvel Calacatta Sublime

AFV5 Marvel Calacatta Perla

AFV6 Marvel Grey Cloud

AFV7 Marvel Fior di Bosco



(S)

± 9 mm

30x60 cm - 11 3/4" x 23 5/8"

AFWD Marvel Calacatta Apuano

AFWE Marvel Calacatta Sublime

AFWF Marvel Calacatta Perla

AFWG Marvel Grey Cloud

AFWH Marvel Fior di Bosco



### OUTDOOR SURFACE



± 20 mm

60x120 cm - 23 5/8" x 47 1/4"

AGFA Marvel Calacatta Apuano Hammered 20 mm

AGFB Marvel Fior di Bosco Hammered 20 mm



(1) The silk finish is suitable for residential or low-traffic commercial floors, where no anti-slip performance is required. The surface's shine and great ease of cleaning are the result of in-depth studies and technical research aimed at ensuring its durability over time. If the product is in direct contact with the outdoors, moisture and dirt absorption devices must be used to prevent scratching. - La finitura silk è indicata per pavimenti residenziali o commerciali poco sollecitati, laddove non siano richieste prestazioni antiscivolo. La lucentezza e l'elevata facilità di pulizia della superficie sono frutto di studi approfonditi e accurate ricerche tecniche volte a garantirne la persistenza nel tempo. Se il prodotto è a diretto contatto con l'esterno, prevedere dei dispositivi di assorbimento dell'umidità e dello sporco per prevenire la formazione di graffi.

(2) (3) Please read the notes at page 401

### COMPLETE YOUR PROJECT



Countertops  
P.402  
162x324 cm  
NON-RECTIFIED



Furniture  
P.356



Sinks  
P.412



Facades  
P.436

SILK/MATTE

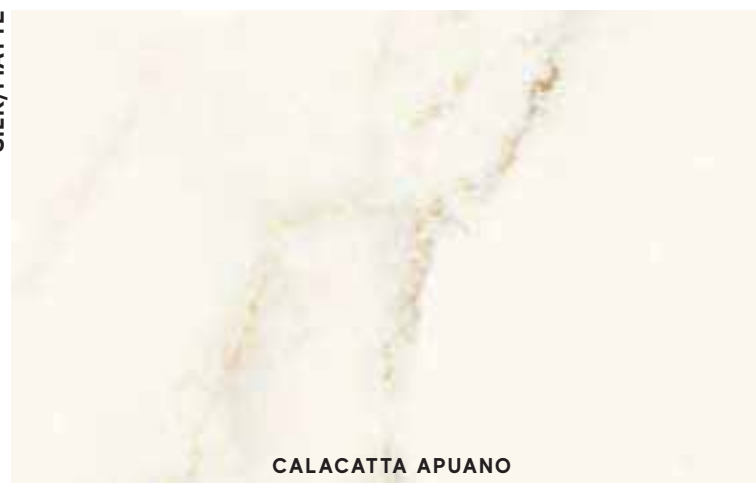

CALACATTA APUANO



CALACATTA SUBLIME



CALACATTA PERLA



GREY CLOUD

HAMMERED

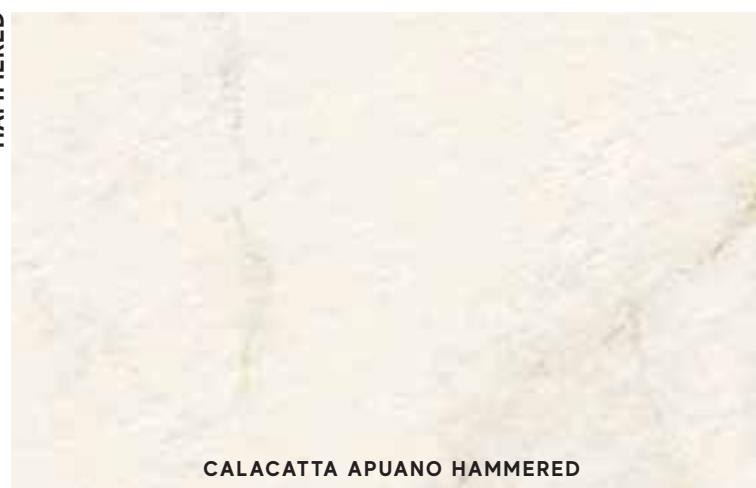

CALACATTA APUANO HAMMERED



FIOR DI BOSCO HAMMERED

INDEX



A COMPLETE  
PRODUCT  
SYSTEM



PRODUCT  
FINDER



SURFACE  
RANGE



COMPANY



COLLECTIONS



3D WALL  
CONCRETE & RESIN LOOK  
METAL LOOK  
MARBLE LOOK  
STONE LOOK  
WOOD LOOK

LARGE SIZES



SLABS FOR  
COUNTERTOPS  
& FURNITURE



SINKS &  
BATHROOM  
FURNISHING



FACADES



TECHNICAL  
SPECIFICATIONS



# Marvel X

## Porcelain Tiles

### DECOR RANGE



AF8W Marvel Calacatta Apuano Mosaico Chevron Polished <sup>(1)</sup>  
46,3x19,2 cm - 18<sup>1</sup>/<sub>4</sub>"x7<sup>1</sup>/<sub>2</sub>"



AF8X Marvel Calacatta Sublime Mosaico Chevron Polished <sup>(1)</sup>  
46,3x19,2 cm - 18<sup>1</sup>/<sub>4</sub>"x7<sup>1</sup>/<sub>2</sub>"



AF8Y Marvel Calacatta Perla Mosaico Chevron Polished <sup>(1)</sup>  
46,3x19,2 cm - 18<sup>1</sup>/<sub>4</sub>"x7<sup>1</sup>/<sub>2</sub>"

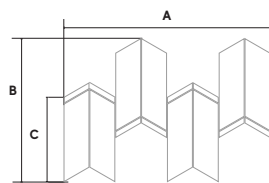

**A** 46,3 cm - 18<sup>1</sup>/<sub>4</sub>"  
**B** 32,2 cm - 12<sup>5</sup>/<sub>8</sub>"  
**C** 19,2 cm - 7<sup>1</sup>/<sub>2</sub>"



AF8Z Marvel Grey Cloud Mosaico Chevron Polished <sup>(1)</sup>  
46,3x19,2 cm - 18<sup>1</sup>/<sub>4</sub>"x7<sup>1</sup>/<sub>2</sub>"



AF9A Marvel Fior di Bosco Mosaico Chevron Polished <sup>(1)</sup>  
46,3x19,2 cm - 18<sup>1</sup>/<sub>4</sub>"x7<sup>1</sup>/<sub>2</sub>"



AF8Q Marvel Mosaico Hive Hex Polished <sup>(2)</sup>  
37,2x32,2 - 14<sup>7</sup>/<sub>8</sub>"x12<sup>5</sup>/<sub>8</sub>"

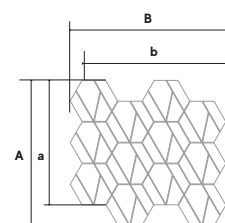

**A** 37 cm - 14<sup>5</sup>/<sub>8</sub>"  
**a** 32,2 cm - 12<sup>5</sup>/<sub>8</sub>"  
**B** 40 cm - 15<sup>1</sup>/<sub>4</sub>"  
**b** 37,2 cm - 14<sup>5</sup>/<sub>8</sub>"

Calacatta Sublime + Grey Cloud + Fior di Bosco



AF8R Marvel Calacatta Apuano Mosaico Waterfall Polished  
30,5x27,7 cm - 12"x10<sup>7</sup>/<sub>8</sub>"



AF8S Calacatta Sublime Mosaico Waterfall Polished  
30,5x27,7 cm - 12"x10<sup>7</sup>/<sub>8</sub>"



AF8T Calacatta Perla Mosaico Waterfall Polished  
30,5x27,7 cm - 12"x10<sup>7</sup>/<sub>8</sub>"



AF8U Calacatta Grey Cloud Mosaico Waterfall Polished  
30,5x27,7 cm - 12"x10<sup>7</sup>/<sub>8</sub>"



AF8V Calacatta Fior di Bosco Mosaico Waterfall Polished  
30,5x27,7 cm - 12"x10<sup>7</sup>/<sub>8</sub>"

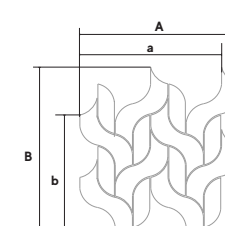

**A** 34,2 cm - 13<sup>1</sup>/<sub>2</sub>"  
**a** 30,5 cm - 12"  
**B** 38 cm - 15"  
**b** 27,7 cm - 10<sup>7</sup>/<sub>8</sub>"



AF8L Marvel Calacatta Apuano Mosaico Esagono Silk  
30x35 - 11<sup>1</sup>/<sub>4</sub>"x13<sup>3</sup>/<sub>4</sub>"



AF8M Marvel Calacatta Sublime Mosaico Esagono Silk  
30x35 - 11<sup>1</sup>/<sub>4</sub>"x13<sup>3</sup>/<sub>4</sub>"



AF8N Marvel Calacatta Perla Mosaico Esagono Silk  
30x35 - 11<sup>1</sup>/<sub>4</sub>"x13<sup>3</sup>/<sub>4</sub>"



AF8O Marvel Grey Cloud Mosaico Esagono Silk  
30x35 - 11<sup>1</sup>/<sub>4</sub>"x13<sup>3</sup>/<sub>4</sub>"



AF8P Marvel Fior di Bosco Mosaico Esagono Silk  
30x35 - 11<sup>1</sup>/<sub>4</sub>"x13<sup>3</sup>/<sub>4</sub>"

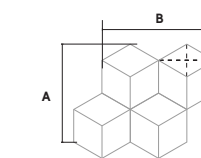

**A** 30 cm - 11<sup>1</sup>/<sub>4</sub>"  
**B** 35 cm - 13<sup>1</sup>/<sub>4</sub>"  
10x17 cm - 3<sup>7</sup>/<sub>8</sub>"x6<sup>3</sup>/<sub>4</sub>"



AF9B Marvel Calacatta Apuano Mosaico Matte  
30x30 - 11<sup>1</sup>/<sub>4</sub>"x11<sup>1</sup>/<sub>4</sub>"

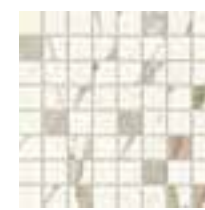

AF9C Marvel Calacatta Sublime Mosaico Matte  
30x30 - 11<sup>1</sup>/<sub>4</sub>"x11<sup>1</sup>/<sub>4</sub>"

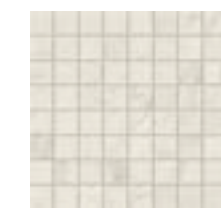

AF9D Marvel Calacatta Perla Mosaico Matte  
30x30 - 11<sup>1</sup>/<sub>4</sub>"x11<sup>1</sup>/<sub>4</sub>"

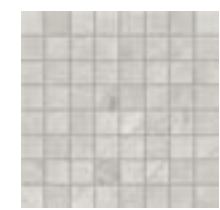

AF9E Marvel Grey Cloud Mosaico Matte  
30x30 - 11<sup>1</sup>/<sub>4</sub>"x11<sup>1</sup>/<sub>4</sub>"



AF9F Marvel Fior di Bosco Mosaico Matte  
30x30 - 11<sup>1</sup>/<sub>4</sub>"x11<sup>1</sup>/<sub>4</sub>"

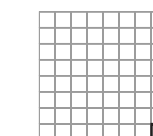

3,5x3,5 cm  
1<sup>1</sup>/<sub>8</sub>"x1<sup>1</sup>/<sub>8</sub>"

<sup>(1)</sup> The decoration can only be laid on the wall - Il decoro si può posare solo a rivestimento - Décor uniquement mural - Das Dekor kann nur an der Wand verlegt werden  
La decoración se puede colocar únicamente en paredes - Декор может быть уложен только на стену.

<sup>(2)</sup> Contains gold. The use of a common mild detergent is recommended. Avoid using acidic or alkaline products, waxes, steel wool, or abrasives. - Parti in oro. Si consiglia l'utilizzo di un comune detergente neutro. Evitare l'utilizzo di prodotti acidi o alcalini, ceranti, pagliette di metallo o abrasive. - Parties dorées. Nous vous conseillons d'utiliser des détergents neutres courants. Éviter l'utilisation de cires et de produits acides ou alcalins, ainsi que les pailles métalliques ou abrasives - Teile aus Gold. Es empfiehlt sich, ein haushaltsübliches, neutrales Reinigungsmittel zu verwenden. Saure oder alkalische Produkte, Wachs sowie Metallwolle- bzw. Scheuerschwämme sind zu vermeiden. - Partes doradas. Recomendamos utilizar un detergente neutro común. Hay que evitar el uso de productos ácidos o alcalinos, ceras y estropajos de metal o abrasivos. - Золотые детали. Рекомендуется чистить обычным нейтральным моющим средством. Не рекомендуется использовать кислотные, щелочные, восковые средства, а также металлические мочалки.

<sup>(3)</sup> For an optimal look it is advisable to lay the product in the same direction. - Per un risultato estetico ottimale si consiglia di posare il prodotto mantenendo lo stesso verso. - Pour un résultat esthétique optimal, il est recommandé de poser le produit dans le même sens. - Für ein optisch optimales Resultat sollte die Verlegung stets in dieselbe Richtung erfolgen. - Para un resultado estético óptimo, se recomienda colocar el producto manteniendo la misma dirección. - Для оптимального эстетического результата рекомендуется укладывать изделие в одном направлении.

TRIM TILES p. 352	Battiscopa		Gradino *		Scalino *		Scalino Ang.*		Battiscopa Sag. Scala *				Corner * ± 6 mm		Corner A, E * ± 6 mm																
	7.2x150 cm 2 <sup>7</sup> / <sub>8</sub> "x59"	7.2x120 cm 2 <sup>7</sup> / <sub>8</sub> "x47 <sup>1</sup> / <sub>2</sub> "	7.2x60 cm 2 <sup>7</sup> / <sub>8</sub> "x23 <sup>3</sup> / <sub>8</sub> "	30x120 cm 11 <sup>1</sup> / <sub>4</sub> "x47 <sup>1</sup> / <sub>2</sub> "	30x60 cm 11 <sup>1</sup> / <sub>4</sub> "x23 <sup>3</sup> / <sub>8</sub> "	37.5x150 cm 14 <sup>1</sup> / <sub>2</sub> "x59"	33x120 cm 13"x47 <sup>1</sup> / <sub>2</sub> "	33x60 cm 13"x23 <sup>3</sup> / <sub>8</sub> "	37.5x37.5 cm 14 <sup>1</sup> / <sub>2</sub> "x14 <sup>1</sup> / <sub>2</sub> "	33x33 cm 13"x13"	7.2x30 cm 2 <sup>7</sup> / <sub>8</sub> "x11 <sup>1</sup> / <sub>2</sub> "				1x120 cm 3 <sup>7</sup> / <sub>8</sub> "x47 <sup>1</sup> / <sub>2</sub> "	1x1 cm 3 <sup>7</sup> / <sub>8</sub> "x11 <sup>1</sup> / <sub>2</sub> "															
	Pol.	Silk	Pol.	Silk	Matte	Pol.	Silk	Matte	Pol.	Silk	Polished	Matte	Silk	Pol.	Silk	Pol.	Silk														
Calacatta Apuano	AGF8	AGGD	AGFV	AGFØ	AGFO	AGFI	AGFD	AGHM	AGHH	AGIO	AGIU	AGH7	AGID	AGII	AGHS	AGHX	AGJN	AGJI	AGI8	AGIZ	AGJD	AGGV	AGGØ	AGGI	AGGO	AGG6	AGHC	AGJX	AGJS	AGJ9	AGJ4
Calacatta Sublime	AGF9	AGGE	AGFW	AGF1	AGFR	AGFJ	AGFE	AGHN	AGHI	AGIP	AGIV	AGH9	AGIE	AGJU	AGHT	AGHY	AGJO	AGJJ	AGI9	AGIØ	AGJE	AGGW	AGG2	AGGJ	AGGP	AGG7	AGHD	AGJY	AGKA	AGJ5	
Calacatta Perla	AGGA	AGGF	AGFX	AGF2	AGFS	AGFK	AGFF	AGHO	AGHJ	AGIQ	AGIW	AGIA	AGIF	AGIK	AGHU	AGHZ	AGJP	AGJK	AGJA	AGI5	AGJF	AGGX	AGG3	AGGL	AGGQ	AGG8	AGHE	AGJZ	AGJU	AGKB	AGJ6
Grey Cloud	AGGB	AGGG	AGFY	AGF3	AGFT	AGFM	AGFG	AGHP	AGHK	AGIS	AGIX	AGIB	AGIG	AGIL	AGHV	AGHØ	AGJQ	AGJL	AGJB	AGI6	AGJG	AGGY	AGG4	AGGM	AGGS	AGHA	AGHF	AGJØ	AGJV	AGKC	AGJ7
Fior di Bosco	AGGC	AGGH	AGFZ	AGF5	AGFU	AGFN	AGFH	AGHQ	AGHL	AGIT	AGIY	AGIC	AGIH	AGIN	AGHW	AGH5	AGJR	AGJM	AGJC	AGI7	AGJH	AGGZ	AGG5	AGGN	AGGU	AGHB	AGHG	AGJ1	AGJW	AGKD	AGJ8
Calacatta Apuano Hammered	-	-	-	-	AGF6	-	-	-	-	-	-	-	-	-	-	-	-	-	-	-	-	-	-	-	-	-	-	-	-	-	-
Fior di Bosco Hammered	-	-	-	-	AGF7	-	-	-	-	-	-	-	-	-	-	-	-	-	-	-	-	-	-	-	-	-	-	-	-	-	

\* These parts are supplied to order - I pezzi sono disponibili su ordinazione - Les pièces sont disponibles sur commande - Die Teile sind auf Bestellung lieferbar - Las piezas se hacen por encargo - Изготавливаются на заказ

# Aix

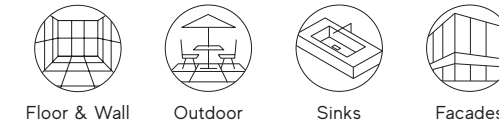

© Ceramiche Atlas Concorde

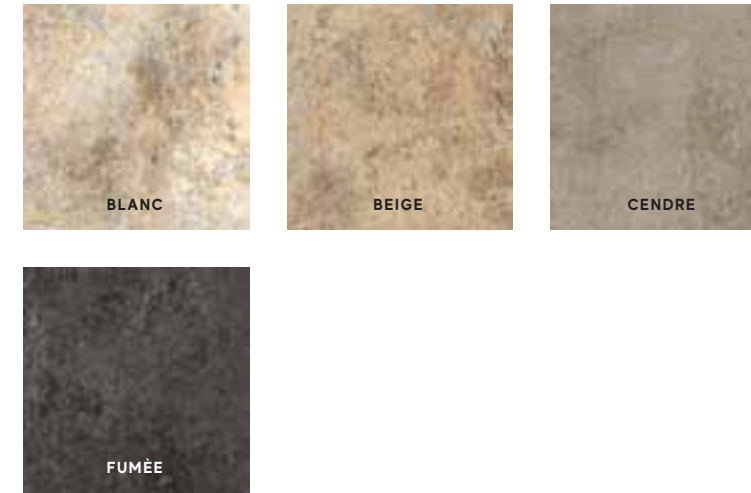

## Porcelain Tiles RECTIFIED MONOCALIBER

Sizes	Thickness	Surface finish
75x150 cm - 29 1/2" x 59"	± 9 mm	Matte Sensitech R10 B
75x75 cm - 29 1/2" x 29 1/2"	± 9 mm	Matte Sensitech R10 B
37,5x75 cm - 14 3/4" x 29 1/2"	± 9 mm	Matte Sensitech R10 B

### OUTDOOR AND WET AREAS

37,5x75 cm - 14 3/4" x 29 1/2"	± 9 mm	Grip R11 C
60x90 cm - 23 5/8" x 35 3/8"	± 20 mm	Outdoor R11 C



© Ceramiche Atlas Concorde



© Ceramiche Atlas Concorde

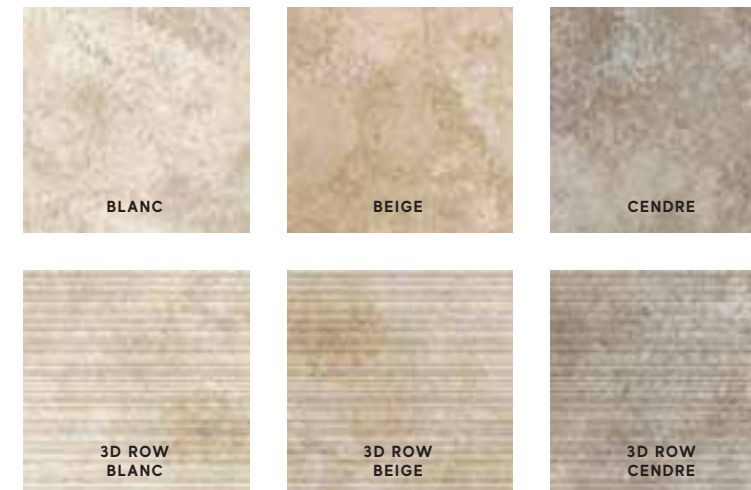

## Wall Tiles RECTIFIED MONOCALIBER

Sizes	Thickness	Surface finish
40x80 cm - 15 3/4" x 31 1/2"	± 8,5 mm	Matte
<b>3D WALL TILES</b>		
40x80 cm - 15 3/4" x 31 1/2"	± 10 mm	Matte

INDEX

A COMPLETE PRODUCT SYSTEM

PRODUCT FINDER

SURFACE RANGE

COMPANY

COLLECTIONS

3D WALL  
CONCRETE & RESIN LOOK  
METAL LOOK  
MARBLE LOOK  
STONE LOOK  
WOOD LOOK

LARGE SIZES

SLABS FOR COUNTERTOPS & FURNITURE

SINKS & BATHROOM FURNISHING

FACADES

TECHNICAL SPECIFICATIONS

# Aix

## Porcelain Tiles

### MATTE SURFACE



± 9 mm  
**75x150 cm** - 29<sup>1</sup>/<sub>2</sub>"x59"  
 A7GJ Aix Blanc  
 A7GK Aix Beige  
 A7GL Aix Cendre  
 A7GM Aix Fumée



± 9 mm  
**75x75 cm** - 29<sup>1</sup>/<sub>2</sub>"x29<sup>1</sup>/<sub>2</sub>"  
 APSC Aix Blanc  
 APSD Aix Beige  
 APSE Aix Cendre  
 APSF Aix Fumée



± 9 mm  
**37,5x75 cm** - 14<sup>3</sup>/<sub>4</sub>"x29<sup>1</sup>/<sub>2</sub>"  
 APSG Aix Blanc  
 APSI Aix Beige  
 APSJ Aix Cendre  
 APSK Aix Fumée

### GRIP SURFACE



± 9 mm  
**37,5x75 cm** - 14<sup>3</sup>/<sub>4</sub>"x29<sup>1</sup>/<sub>2</sub>"  
 APSL Aix Blanc Grip  
 APSM Aix Beige Grip  
 APSO Aix Cendre Grip  
 APSQ Aix Fumée Grip

### OUTDOOR ± 20 mm



± 20 mm  
**60x90 cm** - 23<sup>5</sup>/<sub>8</sub>"x35<sup>3</sup>/<sub>8</sub>"  
 APS1 Aix Blanc 20 mm  
 APS2 Aix Beige 20 mm  
 APS4 Aix Cendre 20 mm  
 APS5 Aix Fumée 20 mm



Matte ± 9 mm  
 Grip ± 9 mm  
 Outdoor ± 20 mm



R10 B Matte Sensitech (S) ± 9 mm  
 R11 C Grip ± 9 mm  
 R11 C Outdoor ± 20 mm



V3 Moderate  
 Variation



BLANC



BEIGE



CENDRE

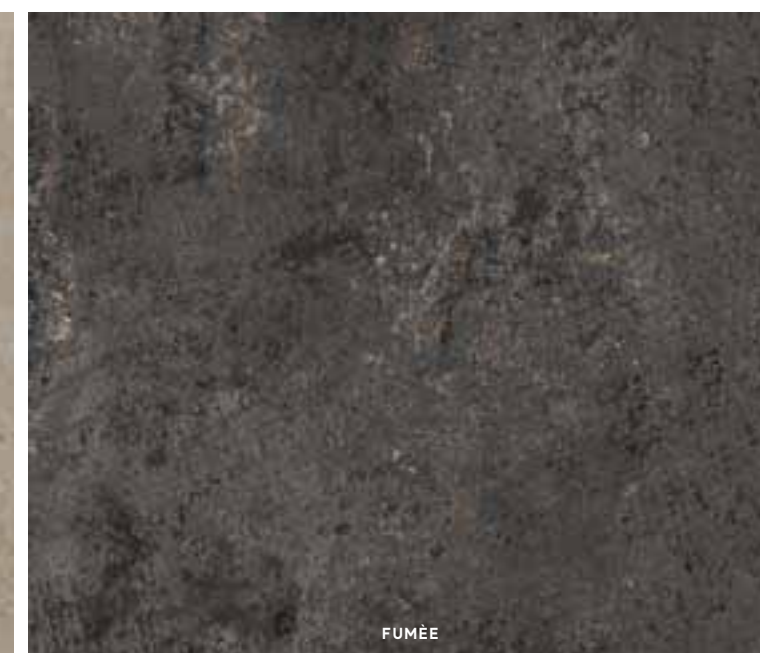

FUMÉE

### TRIM TILES p. 352

	Battiscopa	Gradino *	Scalino *	Scalino Ang.*	Battiscopa Sag. Scala *	Elemento L Grip *
	7,2x75 cm 2 <sup>7</sup> / <sub>8</sub> "x29 <sup>1</sup> / <sub>2</sub> "	37,5x75 cm 14 <sup>3</sup> / <sub>4</sub> "x29 <sup>1</sup> / <sub>2</sub> "	37,5x150 cm 14 <sup>3</sup> / <sub>4</sub> "x59"	37,5x75 cm 14 <sup>3</sup> / <sub>4</sub> "x29 <sup>1</sup> / <sub>2</sub> "	7,2x30 cm 2 <sup>7</sup> / <sub>8</sub> "x11 <sup>7</sup> / <sub>8</sub> "	15x75 H. 4 cm 5 <sup>7</sup> / <sub>8</sub> "x29 <sup>1</sup> / <sub>2</sub> " H. 1 <sup>1</sup> / <sub>2</sub> "
	Matte	Matte	Matte	Matte	Matte	Matte
Blanc	AØSF	AØSR	AØSV	AØTJ	DX AØSJ	AØTR
Beige	AØSG	AØSS	AØSW	AØTK	SX AØSN	AØTS
Cendre	AØSH	AØST	AØSX	AØTP	AØSK AØSL	AØTT
Fumée	AØSI	AØSU	AØSY	AØTQ	AØSO AØSP AØSQ	AØTU

\* These parts are supplied to order - I pezzi sono disponibili su ordinazione - Les pièces sont disponibles sur commande - Die Teile sind auf Bestellung lieferbar - Las piezas se hacen por encargo - Изготавливаются на заказ

### COMPLETE YOUR PROJECT

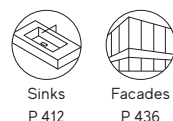

A COMPLETE  
PRODUCT  
SYSTEM >

PRODUCT  
FINDER >

SURFACE  
RANGE >

COMPANY >

COLLECTIONS >

3D WALL  
CONCRETE & RESIN LOOK  
METAL LOOK  
MARBLE LOOK  
STONE LOOK  
WOOD LOOK

LARGE SIZES >

SLABS FOR  
COUNTERTOPS  
& FURNITURE >

SINKS &  
BATHROOM  
FURNISHING >

FACADES >

TECHNICAL  
SPECIFICATIONS >

# Aix

## Porcelain Tiles

### DECOR RANGE



**AØ4X Aix Blanc Kit Multifformato Tumbled <sup>(1)</sup>**  
 1 pcs 75x75 - 29 1/2" x 29 1/2"  
 1 pcs 50x75 - 19 5/8" x 29 1/2"  
 1 pcs 50x50 - 19 5/8" x 19 5/8"  
 3 pcs 25x50 - 9 7/8" x 19 5/8"  
 2 pcs 25x25 - 9 7/8" x 9 7/8"



**AØ4Y Aix Beige Kit Multifformato Tumbled <sup>(1)</sup>**  
 1 pcs 75x75 - 29 1/2" x 29 1/2"  
 1 pcs 50x75 - 19 5/8" x 29 1/2"  
 1 pcs 50x50 - 19 5/8" x 19 5/8"  
 3 pcs 25x50 - 9 7/8" x 19 5/8"  
 2 pcs 25x25 - 9 7/8" x 9 7/8"



**AØ4Z Aix Cendre Kit Multifformato Tumbled <sup>(1)</sup>**  
 1 pcs 75x75 - 29 1/2" x 29 1/2"  
 1 pcs 50x75 - 19 5/8" x 29 1/2"  
 1 pcs 50x50 - 19 5/8" x 19 5/8"  
 3 pcs 25x50 - 9 7/8" x 19 5/8"  
 2 pcs 25x25 - 9 7/8" x 9 7/8"

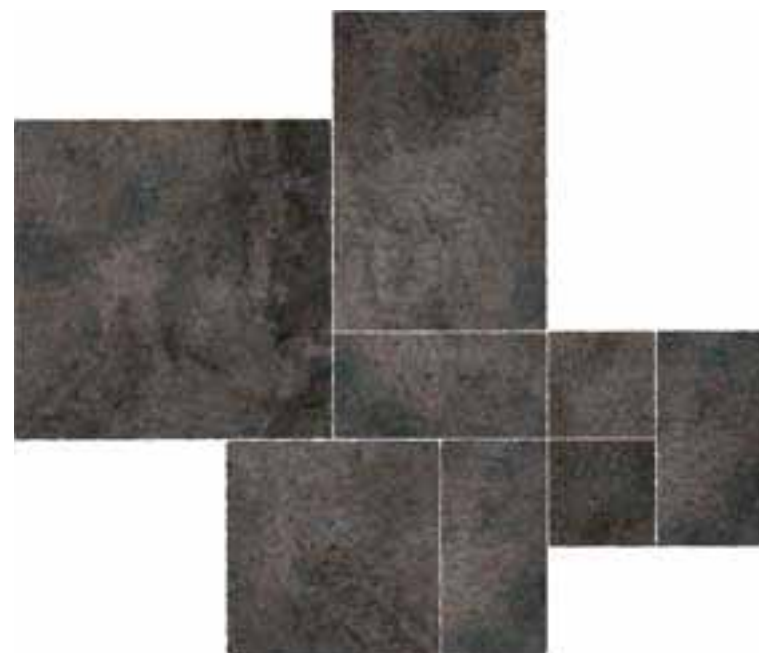

**AØ5C Aix Fumée Kit Multifformato Tumbled <sup>(1)</sup>**  
 1 pcs 75x75 - 29 1/2" x 29 1/2"  
 1 pcs 50x75 - 19 5/8" x 29 1/2"  
 1 pcs 50x50 - 19 5/8" x 19 5/8"  
 3 pcs 25x50 - 9 7/8" x 19 5/8"  
 2 pcs 25x25 - 9 7/8" x 9 7/8"

<sup>(1)</sup> **Tumbled. Irregularities in the edges are not defects but rather features intrinsic to this type of product.** - Burattato. Le irregolarità del bordo non sono da considerarsi un difetto ma una caratteristica intrinseca di questa tipologia di prodotto. - Tamisé. Les irrégularités des bords ne doivent pas être considérées comme un défaut mais comme une caractéristique intrinsèque de ce type de produit. - Genarbt. Die unregelmäßigen Kanten sind nicht als Fehler zu betrachten, sie sind ein für dieses Produkt charakteristisches Merkmal. - Tamboreado. Las irregularidades de los bordes no deben considerarse un defecto, sino una característica intrínseca de este tipo de productos. - Галтованная мозаика. Неровности граней являются не дефектом, а неотъемлемой характеристикой данного вида изделий.  
**The miniatures of the Kit Multifformato are not in proportion.** - I minimali nel Kit Multifformato non sono in proporzione. - Les illustrations à échelle réduite dans le Kit Multifformato ne sont pas proportionnelles. - Die Abbildungen im Kit Multifformato sind nicht verhältnismäßig. - Los miniaturas en el Kit Multifformato no están en proporción. - Изображения Kit Multifformato не соблюдают пропорций.



**AØUA Aix Blanc Honeycomb Tumbled <sup>(1)</sup>** 30x31 - 11 1/4" x 12 1/4"  
**AØUB Aix Beige Honeycomb Tumbled <sup>(1)</sup>** 30x31 - 11 1/4" x 12 1/4"  
**AØUC Aix Cendre Honeycomb Tumbled <sup>(1)</sup>** 30x31 - 11 1/4" x 12 1/4"  
**AØUD Aix Fumée Honeycomb Tumbled <sup>(1)</sup>** 30x31 - 11 1/4" x 12 1/4"



**AØTZ Aix Blanc Mosaico Tumbled <sup>(1)</sup>** 30x30 - 11 1/4" x 11 1/4"  
**AØTØ Aix Beige Mosaico Tumbled <sup>(1)</sup>** 30x30 - 11 1/4" x 11 1/4"  
**AØT8 Aix Cendre Mosaico Tumbled <sup>(1)</sup>** 30x30 - 11 1/4" x 11 1/4"  
**AØT9 Aix Fumée Mosaico Tumbled <sup>(1)</sup>** 30x30 - 11 1/4" x 11 1/4"



**AØUE Aix Blanc Brick Tumbled <sup>(1)</sup>** 37x37 - 14 5/8" x 14 5/8"



**AØUF Aix Beige Brick Tumbled <sup>(1)</sup>** 37x37 - 14 5/8" x 14 5/8"



**AØUG Aix Cendre Brick Tumbled <sup>(1)</sup>** 37x37 - 14 5/8" x 14 5/8"



**AØUH Aix Fumée Brick Tumbled <sup>(1)</sup>** 37x37 - 14 5/8" x 14 5/8"

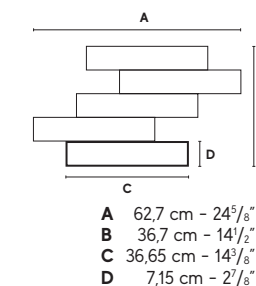
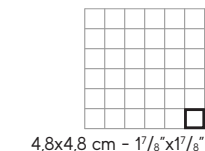
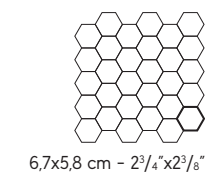

INDEX



A COMPLETE PRODUCT SYSTEM



PRODUCT FINDER



SURFACE RANGE



COMPANY



COLLECTIONS



3D WALL  
 CONCRETE & RESIN LOOK  
 METAL LOOK  
 MARBLE LOOK  
 STONE LOOK  
 WOOD LOOK

LARGE SIZES



SLABS FOR COUNTERTOPS & FURNITURE



SINKS & BATHROOM FURNISHING



FACADES



TECHNICAL SPECIFICATIONS



# Aix

## Wall Tiles

### MATTE SURFACE

  $\pm 8.5 \text{ mm}$   
**40x80 cm** - 15<sup>3</sup>/<sub>4</sub>"x31<sup>1</sup>/<sub>2</sub>"  
 8AIB Aix Blanc  
 8AIE Aix Beige  
 8AIC Aix Cendre

  $\pm 10 \text{ mm 3D WALL}$   
**40x80 cm** - 15<sup>3</sup>/<sub>4</sub>"x31<sup>1</sup>/<sub>2</sub>"  
 8A3B Aix 3D Row Blanc  
 8A3E Aix 3D Row Beige  
 8A3C Aix 3D Row Cendre

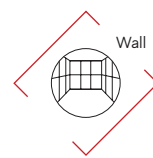

### TRIM TILES



**1.4x40 cm** - 5<sup>5</sup>/<sub>8</sub>"x15<sup>3</sup>/<sub>4</sub>"  
 LAII Aix Blanc Corner 40 \*  
 LAIC Aix Cendre Corner 40 \*  
 LAIE Aix Beige Corner 40 \*  
 LA3B Aix 3D Blanc Corner 40 \*  
 LA3C Aix 3D Cendre Corner 40 \*  
 LA3E Aix 3D Beige Corner 40 \*



**1.4x1.4 cm** - 5<sup>5</sup>/<sub>8</sub>"x5<sup>5</sup>/<sub>8</sub>"  
 AØIB Aix Blanc Corner A.E. 1.4 \*  
 AØIC Aix Cendre Corner A.E. 1.4 \*  
 AØIE Aix Beige Corner A.E. 1.4 \*

\* **These parts are supplied to order** - I pezzi sono disponibili su ordinazione - Les pièces sont disponibles sur commande - Die Teile sind auf Bestellung lieferbar - Las piezas se hacen por encargo - Изготавливаются на заказ

<sup>(1)</sup> **Tumbled. Irregularities in the edges are not defects but rather features intrinsic to this type of product.** - Burattato. Le irregolarità del bordo non sono da considerarsi un difetto ma una caratteristica intrinseca di questa tipologia di prodotto. - Tamisé. Les irrégularités des bords ne doivent pas être considérées comme un défaut mais comme une caractéristique intrinsèque de ce type de produit. - Ganarbt. Die unregelmäßigen Kanten sind nicht als Fehler zu betrachten, sie sind ein für dieses Produkt charakteristisches Merkmal. - Tamboreado. Las irregularidades de los bordes no deben considerarse un defecto, sino una característica intrínseca de este tipo de productos. - Гальтованная мозаика. Неровности граней являются не дефектом, а неотъемлемой характеристикой данного вида изделий.

### DECOR RANGE



9AKB Aix Blanc  
Minibrick Tumbled <sup>(1)</sup>  
30,5x30,5 - 12"x12"



9AKE Aix Beige  
Minibrick Tumbled <sup>(1)</sup>  
30,5x30,5 - 12"x12"



9AKC Aix Cendre  
Minibrick Tumbled <sup>(1)</sup>  
30,5x30,5 - 12"x12"

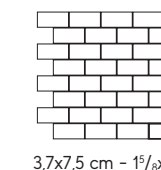

INDEX



A COMPLETE  
PRODUCT  
SYSTEM



PRODUCT  
FINDER



SURFACE  
RANGE



COMPANY



COLLECTIONS



3D WALL  
CONCRETE & RESIN LOOK  
METAL LOOK  
MARBLE LOOK  
STONE LOOK  
WOOD LOOK

LARGE SIZES



SLABS FOR  
COUNTERTOPS  
& FURNITURE



SINKS &  
BATHROOM  
FURNISHING



FACADES



TECHNICAL  
SPECIFICATIONS



# Boost Mix



© Ceramiche Atlas Concorde



© Ceramiche Atlas Concorde



© Ceramiche Atlas Concorde



## Porcelain Tiles RECTIFIED MONOCALIBER

Sizes	Thickness	Surface finish
120x278 cm - 47 <sup>1</sup> / <sub>4</sub> "x109 <sup>1</sup> / <sub>2</sub> "	± 6 mm	Matte R9 A
120x120 cm - 47 <sup>1</sup> / <sub>4</sub> "x47 <sup>1</sup> / <sub>4</sub> "	± 9 mm	Matte Sensitech R10 B
60x120 cm - 23 <sup>3</sup> / <sub>8</sub> "x47 <sup>1</sup> / <sub>4</sub> "	± 9 mm	Matte Sensitech R10 B
60x60 cm - 23 <sup>3</sup> / <sub>8</sub> "x23 <sup>3</sup> / <sub>8</sub> "	± 9 mm	Matte Sensitech R10 B
30x60 cm - 11 <sup>3</sup> / <sub>4</sub> "x23 <sup>3</sup> / <sub>8</sub> "	± 9 mm	Matte Sensitech R10 B

### LARGE SIZES P. 356

OUTDOOR AND WET AREAS	Thickness	Surface finish
30x60 cm - 11 <sup>3</sup> / <sub>4</sub> "x23 <sup>3</sup> / <sub>8</sub> "	± 9 mm	Grip R11 C
120x120 cm - 47 <sup>1</sup> / <sub>4</sub> "x47 <sup>1</sup> / <sub>4</sub> "	± 20 mm	Outdoor R11 C
60x120 cm - 23 <sup>3</sup> / <sub>8</sub> "x47 <sup>1</sup> / <sub>4</sub> "	± 20 mm	Outdoor R11 C
60x60 cm - 23 <sup>3</sup> / <sub>8</sub> "x23 <sup>3</sup> / <sub>8</sub> "	± 20 mm	Outdoor R11 C

INDEX

A COMPLETE PRODUCT SYSTEM

PRODUCT FINDER

SURFACE RANGE

COMPANY

COLLECTIONS

- 3D WALL
- CONCRETE & RESIN LOOK
- METAL LOOK
- MARBLE LOOK
- STONE LOOK
- WOOD LOOK

LARGE SIZES

SLABS FOR COUNTERTOPS & FURNITURE

SINKS & BATHROOM FURNISHING

FACADES

TECHNICAL SPECIFICATIONS



# Boost Mix

## Porcelain Tiles



Matte ± 6 mm



Matte Sensitech (S) ± 9 mm  
Grip ± 9 mm  
Outdoor ± 20 mm



R9 A Matte ± 6 mm  
R10 B Matte Sensitech (S) ± 9 mm  
R11 C Grip ± 9 mm  
R11 C Outdoor ± 20 mm



### MATTE SURFACE

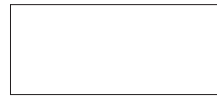

± 6 mm  
120x278 cm - 47 1/4" x 109 1/2"  
A8Y7 Boost Mix Ivory  
A8Y8 Boost Mix Pearl  
A8Y9 Boost Mix Smoke



± 9 mm  
120x120 cm - 47 1/4" x 47 1/4"  
A8XD Boost Mix Ivory  
A8XE Boost Mix Pearl  
A8XF Boost Mix Smoke



± 9 mm  
60x120 cm - 23 5/8" x 47 1/4"  
A8ØI Boost Mix Ivory  
A8ØJ Boost Mix Pearl  
A8ØK Boost Mix Smoke



± 9 mm  
60x60 cm - 23 5/8" x 23 5/8"  
A8ØL Boost Mix Ivory  
A8ØM Boost Mix Pearl  
A8ØN Boost Mix Smoke



± 9 mm  
30x60 cm - 11 3/4" x 23 5/8"  
A8ØO Boost Mix Ivory  
A8ØP Boost Mix Pearl  
A8ØQ Boost Mix Smoke

### GRIP SURFACE



± 9 mm  
30x60 cm - 11 3/4" x 23 5/8"  
A8ØR Boost Mix Ivory Grip  
A8ØS Boost Mix Pearl Grip  
A8ØT Boost Mix Smoke Grip

### OUTDOOR ± 20 mm



± 20 mm  
120x120 cm - 47 1/4" x 47 1/4"  
A84U Boost mix Ivory 20 mm  
A84V Boost mix Pearl 20 mm  
A84W Boost mix Smoke 20 mm



± 20 mm  
60x120 cm - 23 5/8" x 47 1/4"  
A84R Boost Mix Ivory 20 mm  
A84S Boost Mix Pearl 20 mm  
A84T Boost Mix Smoke 20 mm



± 20 mm  
60x60 cm - 23 5/8" x 23 5/8"  
A84O Boost Mix Ivory 20 mm  
A84P Boost Mix Pearl 20 mm  
A84Q Boost Mix Smoke 20 mm



IVORY

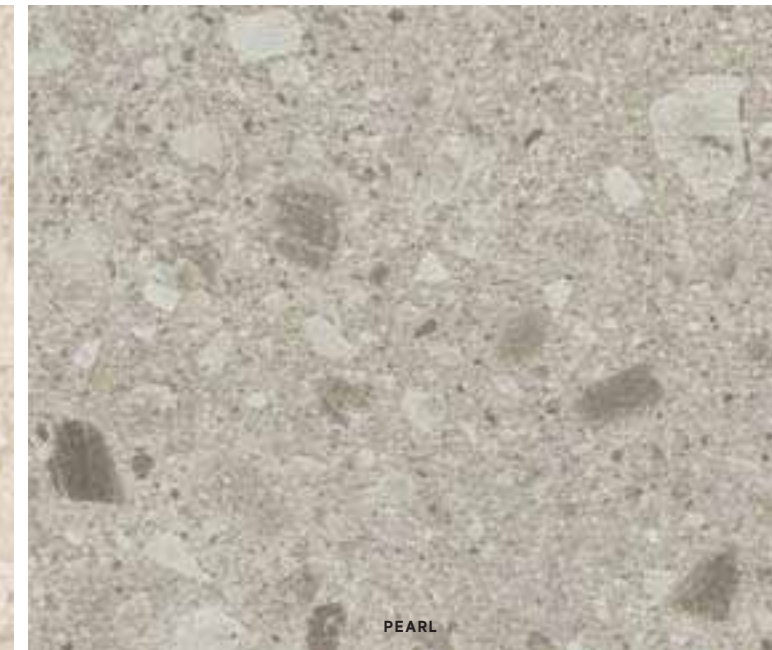

PEARL

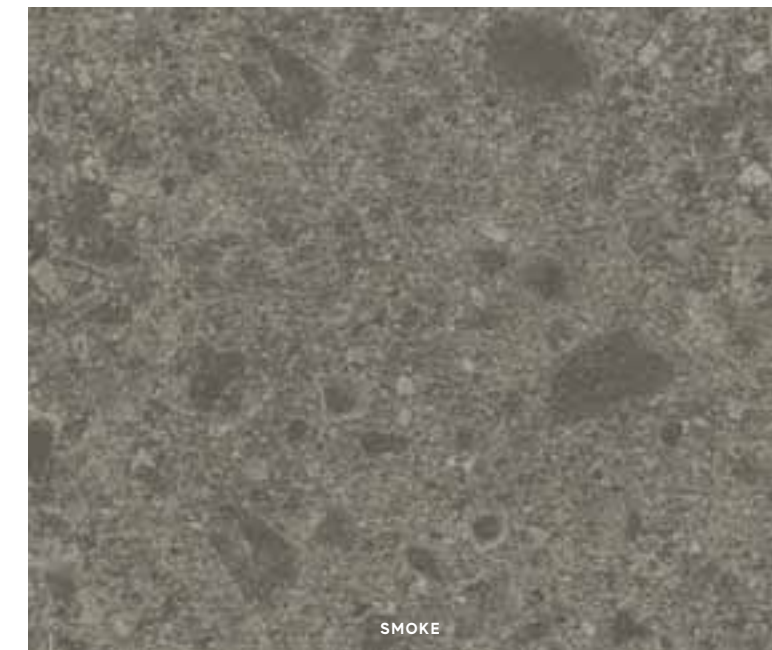

SMOKE

### TRIM TILES p. 352

	Battiscopa		Gradino *		Scalino *		Scalino Ang.*	Battiscopa Sag. Scala *		Elemento L	Corner * ± 6 mm	Corner A.E * ± 6 mm
	7,2x120 cm 2 7/8" x 47 1/4"	7,2x60 cm 2 7/8" x 23 5/8"	30x120 cm 11 7/8" x 47 1/4"	30x60 cm 11 7/8" x 23 5/8"	33x120 cm 13" x 47 1/4"	33x60 cm 13" x 23 5/8"	33x33 cm 13" x 13"	7,2x30 cm 2 7/8" x 11 7/8"	15x60 H. 4 cm 5 7/8" x 23 5/8" H. 1 1/2"	1x120 cm 3/4" x 47 1/4"	1x1 cm 3/4" x 1/4"	
	Matte	Matte	Matte	Matte	Matte	Matte	Matte	Matte	Grip	Matte	Matte	
Ivory	A83O	A83L	A832	A83X	A838	A835	A84C	DX A83U	SX A83R	A84F	A84I	A84L
Pearl	A83P	A83M	A833	A83Y	A839	A836	A84D	A83V	A83S	A84G	A84J	A84M
Smoke	A83Q	A83N	A834	A83Z	A84B	A837	A84E	A83W	A83T	A84H	A84K	A84N

\* These parts are supplied to order - I pezzi sono disponibili su ordinazione - Les pièces sont disponibles sur commande - Die Teile sind auf Bestellung lieferbar - Las piezas se hacen por encargo - Изготавливаются на заказ

### COMPLETE YOUR PROJECT

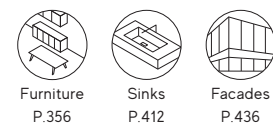

A COMPLETE  
PRODUCT  
SYSTEM >

PRODUCT  
FINDER >

SURFACE  
RANGE >

COMPANY >

COLLECTIONS >

3D WALL  
CONCRETE & RESIN LOOK  
METAL LOOK  
MARBLE LOOK  
STONE LOOK  
WOOD LOOK

LARGE SIZES >

SLABS FOR  
COUNTERTOPS  
& FURNITURE >

SINKS &  
BATHROOM  
FURNISHING >

FACADES >

TECHNICAL  
SPECIFICATIONS >

# Boost Mix

## Porcelain Tiles

### DECOR RANGE



A829 Boost Mix Ivory  
Mosaico Matte  
30x30 - 1<sup>1</sup>/<sub>4</sub>"x1<sup>1</sup>/<sub>4</sub>"



A83G Boost Mix Pearl  
Mosaico Matte  
30x30 - 1<sup>1</sup>/<sub>4</sub>"x1<sup>1</sup>/<sub>4</sub>"

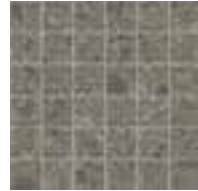

A83H Boost Mix Smoke  
Mosaico Matte  
30x30 - 1<sup>1</sup>/<sub>4</sub>"x1<sup>1</sup>/<sub>4</sub>"



A83I Boost Mix Ivory  
Mosaico Slide <sup>(1)</sup>  
29x32,6 - 1<sup>1</sup>/<sub>8</sub>"x12<sup>1</sup>/<sub>8</sub>"



A83J Boost Mix Pearl  
Mosaico Slide <sup>(1)</sup>  
29x32,6 - 1<sup>1</sup>/<sub>8</sub>"x12<sup>1</sup>/<sub>8</sub>"



A83K Boost Mix Smoke  
Mosaico Slide <sup>(1)</sup>  
29x32,6 - 1<sup>1</sup>/<sub>8</sub>"x12<sup>1</sup>/<sub>8</sub>"

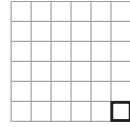

4,8x4,8 cm - 1<sup>7</sup>/<sub>8</sub>"x1<sup>7</sup>/<sub>8</sub>"

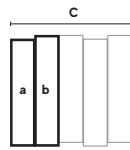

a 6,3x28,8 cm - 2<sup>1</sup>/<sub>2</sub>"x11<sup>1</sup>/<sub>8</sub>"  
b 6,3x29,8 cm - 5<sup>1</sup>/<sub>8</sub>"x11<sup>1</sup>/<sub>4</sub>"  
c 32,57 cm - 12<sup>1</sup>/<sub>8</sub>"



© Ceramiche Atlas Concorde



© Ceramiche Atlas Concorde

<sup>(1)</sup> For the best performance of the mosaic we recommend the use of epoxy mortars (class RG - EN 13888/ISO 13007) or decorative resins-cement, following the manufacturer's instructions. - Al fine di ottenere una resa ottimale del mosaico, è consigliato l'utilizzo di malte epossidiche (classe RG - EN 13888/ISO 13007) o di resine cementizie attendendosi alle indicazioni di utilizzo fornite dal produttore. - Afin d'obtenir un rendu optimal de la mosaïque, nous vous conseillons d'utiliser des mortiers époxy (classe RG - EN 13888/ISO 13007) ou des résines à base de ciment, en suivant les indications d'utilisation fournies par le fabricant. - Um das Mosaik optimal zur Geltung zu bringen, empfehlen wir die Verwendung von Epoxidharzfugenmörtel (Klasse RG - EN 13888/ISO 13007) oder von vergüteten Fugenmörteln unter Beachtung der vom Hersteller angegebenen Verwendungshinweise. - Para obtener un rendimiento óptimo del mosaico, se aconseja utilizar mortero epoxi (clase RG - EN 13888/ISO 13007) o resinas de cemento siguiendo las indicaciones entregadas por el fabricante. - Для наилучшего эстетического результата при укладке мозаики рекомендуется использовать эпоксидные растворы (класс RG - EN 13888/ISO 13007) или полимерцемент, соблюдая инструкции производителя.

INDEX



A COMPLETE  
PRODUCT  
SYSTEM



PRODUCT  
FINDER



SURFACE  
RANGE



COMPANY



COLLECTIONS



3D WALL  
CONCRETE & RESIN LOOK  
METAL LOOK  
MARBLE LOOK  
STONE LOOK  
WOOD LOOK

LARGE SIZES



SLABS FOR  
COUNTERTOPS  
& FURNITURE



SINKS &  
BATHROOM  
FURNISHING



FACADES



TECHNICAL  
SPECIFICATIONS



# Boost Stone



© Ceramiche Atlas Concorde



© Ceramiche Atlas Concorde



© Ceramiche Atlas Concorde

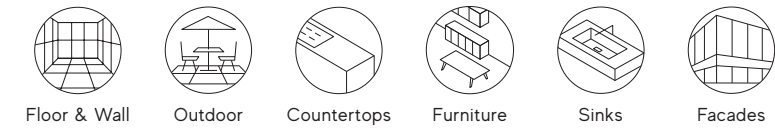

## Porcelain Tiles RECTIFIED MONOCALIBER

Sizes	Thickness	Surface finish
120x278 cm - 47 <sup>1</sup> / <sub>4</sub> "x109 <sup>1</sup> / <sub>2</sub> "	± 6 mm	Matte R9 A
120x120 cm - 47 <sup>1</sup> / <sub>4</sub> "x47 <sup>1</sup> / <sub>4</sub> "	± 9 mm	Matte Sensitech R10 B
60x120 cm - 23 <sup>3</sup> / <sub>8</sub> "x47 <sup>1</sup> / <sub>4</sub> "	± 9 mm	Matte Sensitech R10 B
60x60 cm - 23 <sup>3</sup> / <sub>8</sub> "x23 <sup>3</sup> / <sub>8</sub> "	± 9 mm	Matte Sensitech R10 B
30x60 cm - 11 <sup>3</sup> / <sub>4</sub> "x23 <sup>3</sup> / <sub>8</sub> "	± 9 mm	Matte Sensitech R10 B

### LARGE SIZES P. 356

### OUTDOOR AND WET AREAS

60x120 cm - 23 <sup>3</sup> / <sub>8</sub> "x47 <sup>1</sup> / <sub>4</sub> "	± 9 mm	Grip R11 C
30x60 cm - 11 <sup>3</sup> / <sub>4</sub> "x23 <sup>3</sup> / <sub>8</sub> "	± 9 mm	Grip R11 C
120x120 cm - 47 <sup>1</sup> / <sub>4</sub> "x47 <sup>1</sup> / <sub>4</sub> "	± 20 mm	Outdoor R11 C
60x120 cm - 23 <sup>3</sup> / <sub>8</sub> "x47 <sup>1</sup> / <sub>4</sub> "	± 20 mm	Outdoor R11 C
60x60 cm - 23 <sup>3</sup> / <sub>8</sub> "x23 <sup>3</sup> / <sub>8</sub> "	± 20 mm	Outdoor R11 C

### atlas<sup>PLAN</sup>

### SLABS FOR COUNTERTOPS & FURNITURE

162x324 cm - 63 <sup>3</sup> / <sub>4</sub> "x127 <sup>1</sup> / <sub>2</sub> " NON-RECTIFIED	± 12 mm	Hammered
--	---------	----------



INDEX 

A COMPLETE PRODUCT SYSTEM 

PRODUCT FINDER 

SURFACE RANGE 

COMPANY 

COLLECTIONS 

3D WALL  
CONCRETE & RESIN LOOK  
METAL LOOK  
MARBLE LOOK  
STONE LOOK  
WOOD LOOK

LARGE SIZES 

SLABS FOR COUNTERTOPS & FURNITURE 

SINKS & BATHROOM FURNISHING 

FACADES 

TECHNICAL SPECIFICATIONS 

# Boost Stone

## Porcelain Tiles



Matte ± 6 mm



Matte Sensitech (S) ± 9 mm  
Grip ± 9 mm  
Outdoor ± 20 mm



R9 A Matte ± 6 mm  
R10 B Matte Sensitech (S) ± 9 mm  
R11 C Grip ± 9 mm  
R11 C Outdoor ± 20 mm



V2 Slight Variation



### MATTE SURFACE

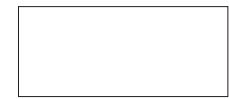

± 6 mm

120x278 cm - 47 1/4" x 109 1/2"

- A6R7 B.Stone White
- A6SC B.Stone Pearl
- A6SD B.Stone Grey
- A6SE B.Stone Smoke
- A6SG B.Stone Tarmac
- A6R8 B.Stone Ivory
- A6R9 B.Stone Cream
- A6SA B.Stone Clay
- A6SB B.Stone Taupe
- A6SF B.Stone Tobacco



± 9 mm

120x120 cm - 47 1/4" x 47 1/4"

- A6QS B.Stone White
- A6QX B.Stone Pearl
- A6QY B.Stone Grey
- A6L8 B.Stone Smoke
- A6QØ B.Stone Tarmac
- A6QT B.Stone Ivory
- A6QU B.Stone Cream
- A6QV B.Stone Clay
- A6QW B.Stone Taupe
- A6QZ B.Stone Tobacco



± 9 mm

60x120 cm - 23 5/8" x 47 1/4"

- A6Q2 B.Stone White
- A6Q7 B.Stone Pearl
- A6Q8 B.Stone Grey
- A6Q9 B.Stone Smoke
- A6RB B.Stone Tarmac
- A6Q3 B.Stone Ivory
- A6Q4 B.Stone Cream
- A6Q5 B.Stone Clay
- A6Q6 B.Stone Taupe
- A6RA B.Stone Tobacco

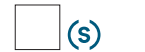

± 9 mm

60x60 cm - 23 5/8" x 23 5/8"

- A6RC B.Stone White
- A6RL B.Stone Pearl
- A6RM B.Stone Grey
- A6RN B.Stone Smoke
- A6RP B.Stone Tarmac
- A6RD B.Stone Ivory
- A6RI B.Stone Cream
- A6RJ B.Stone Clay
- A6RK B.Stone Taupe
- A6RO B.Stone Tobacco



± 9 mm

30x60 cm - 11 3/4" x 23 5/8"

- A6RX B.Stone White
- A6R2 B.Stone Pearl
- A6R3 B.Stone Grey
- A6R4 B.Stone Smoke
- A6R6 B.Stone Tarmac
- A6RY B.Stone Ivory
- A6RZ B.Stone Cream
- A6RØ B.Stone Clay
- A6R1 B.Stone Taupe
- A6R5 B.Stone Tobacco

### GRIP SURFACE



± 9 mm

60x120 cm - 23 5/8" x 47 1/4"

- A66R B.Stone White Grip
- A66W B.Stone Pearl Grip
- A66X B.Stone Grey Grip
- A66Y B.Stone Smoke Grip
- A66Ø B.Stone Tarmac Grip
- A66S B.Stone Ivory Grip
- A66T B.Stone Cream Grip
- A66U B.Stone Clay Grip
- A66V B.Stone Taupe Grip
- A66Z B.Stone Tobacco Grip



± 9 mm

30x60 cm - 11 3/4" x 23 5/8"

- A661 B.Stone White Grip
- A666 B.Stone Pearl Grip
- A667 B.Stone Grey Grip
- A668 B.Stone Smoke Grip
- A67A B.Stone Tarmac Grip
- A662 B.Stone Ivory Grip
- A663 B.Stone Cream Grip
- A664 B.Stone Clay Grip
- A665 B.Stone Taupe Grip
- A669 B.Stone Tobacco Grip

### OUTDOOR ± 20 mm



± 20 mm

120x120 cm - 47 1/4" x 47 1/4"

- A67M B.Stone White 20 mm
- A67P B.Stone Grey 20 mm
- A711 B.Stone Smoke 20 mm
- A67Q B.Stone Tarmac 20 mm
- A67N B.Stone Cream 20 mm
- A67O B.Stone Clay 20 mm



± 20 mm

60x120 cm - 23 5/8" x 47 1/4"

- A67R B.Stone White 20 mm
- A67U B.Stone Grey 20 mm
- A71J B.Stone Smoke 20 mm
- A67V B.Stone Tarmac 20 mm
- A67S B.Stone Cream 20 mm
- A67T B.Stone Clay 20 mm



± 20 mm

60x60 cm - 23 5/8" x 23 5/8"

- A67W B.Stone White 20 mm
- A67Z B.Stone Grey 20 mm
- A71K B.Stone Smoke 20 mm
- A67Ø B.Stone Tarmac 20 mm
- A67X B.Stone Cream 20 mm
- A67Y B.Stone Clay 20 mm

### TRIM TILES

p. 352

	Battiscopa	Gradino *	Scalino *	Scalino Ang. *	Battiscopa Sag. Scala *	Elemento L	Corner * ± 6 mm	Corner A.E * ± 6 mm
	7,2x60 cm 2 7/8" x 23 5/8" Matte	30x60 cm 11 3/4" x 23 5/8" Matte	33x120 cm 13" x 47 1/4" Matte	33x60 cm 13" x 23 5/8" Matte	7,2x30 cm 2 7/8" x 11 3/4" Matte	33x120 H. 4 cm 13" x 47 1/4" H. 1 1/2" Grip	1x120 cm 3/8" x 47 1/4" Matte	1x1 cm 3/8" x 1/8" Matte
White	A7NC	A7N6	A7OQ	A7OG	A7OØ	A7P8	A7PA	A7PK
Pearl	A7NH	A7OB	A7OV	A7OL	A7O5	A7N1	A7NR	A7PD
Grey	A7NI	A7OC	A7OW	A7OM	A7O6	A7N2	A7NS	A7PE
Smoke	A7NJ	A7OD	A7OX	A7ON	A7O7	A7N3	A7NT	A7PH
Tarmac	A7NL	A7OF	A7OZ	A7OP	A7O9	A7N5	A7NV	A7PJ
Ivory	A7ND	A7N7	A7OR	A7OH	A7O1	A7N6	A7NN	A7PB
Cream	A7NE	A7N8	A7OS	A7OI	A7O2	A7N7	A7NO	A7PC
Clay	A7NF	A7N9	A7OT	A7OJ	A7O3	A7N8	A7NP	A7PD
Taupe	A7NG	A7OA	A7OU	A7OK	A7O4	A7NØ	A7NQ	A7PE
Tobacco	A7NK	A7OE	A7OY	A7OO	A7O8	A7N4	A7NU	A7PI

\* These parts are supplied to order - I pezzi sono disponibili su ordinazione - Les pièces sont disponibles sur commande - Die Teile sind auf Bestellung lieferbar - Las piezas se hacen por encargo - Изготавливаются на заказ

### COMPLETE YOUR PROJECT

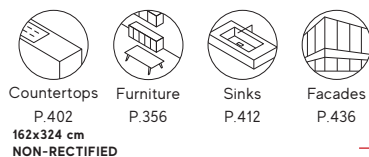

Countertops P.402  
Furniture P.356  
Sinks P.412  
Facades P.436



A COMPLETE PRODUCT SYSTEM >

PRODUCT FINDER >

SURFACE RANGE >

COMPANY >

COLLECTIONS >

3D WALL  
CONCRETE & RESIN LOOK  
METAL LOOK  
MARBLE LOOK  
STONE LOOK  
WOOD LOOK

LARGE SIZES >

SLABS FOR COUNTERTOPS & FURNITURE >

SINKS & BATHROOM FURNISHING >

FACADES >

TECHNICAL SPECIFICATIONS >

# Boost Stone

## Porcelain Tiles

### DECOR RANGE



A7C3 Boost Stone White  
Mosaico Brick  
30x60 cm - 11<sup>1</sup>/<sub>4</sub>"x23<sup>3</sup>/<sub>8</sub>"

A7C4 Boost Stone Ivory  
Mosaico Brick  
30x60 cm - 11<sup>1</sup>/<sub>4</sub>"x23<sup>3</sup>/<sub>8</sub>"



A7C8 Boost Stone Pearl  
Mosaico Brick  
30x60 cm - 11<sup>1</sup>/<sub>4</sub>"x23<sup>3</sup>/<sub>8</sub>"

A7C5 Boost Stone Cream  
Mosaico Brick  
30x60 cm - 11<sup>1</sup>/<sub>4</sub>"x23<sup>3</sup>/<sub>8</sub>"



A7C9 Boost Stone Grey  
Mosaico Brick  
30x60 cm - 11<sup>1</sup>/<sub>4</sub>"x23<sup>3</sup>/<sub>8</sub>"

A7C6 Boost Stone Clay  
Mosaico Brick  
30x60 cm - 11<sup>1</sup>/<sub>4</sub>"x23<sup>3</sup>/<sub>8</sub>"



A7DA Boost Stone Smoke  
Mosaico Brick  
30x60 cm - 11<sup>1</sup>/<sub>4</sub>"x23<sup>3</sup>/<sub>8</sub>"

A7C7 Boost Stone Taupe  
Mosaico Brick  
30x60 cm - 11<sup>1</sup>/<sub>4</sub>"x23<sup>3</sup>/<sub>8</sub>"



A7DC Boost Stone Tarmac  
Mosaico Brick  
30x60 cm - 11<sup>1</sup>/<sub>4</sub>"x23<sup>3</sup>/<sub>8</sub>"

A7DB Boost Stone Tobacco  
Mosaico Brick  
30x60 cm - 11<sup>1</sup>/<sub>4</sub>"x23<sup>3</sup>/<sub>8</sub>"

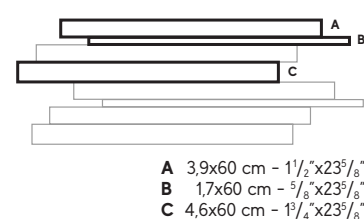

A7DD Boost Stone White  
Mosaico Matte  
30x30 cm - 11<sup>1</sup>/<sub>4</sub>"x11<sup>1</sup>/<sub>4</sub>"

A7DI Boost Stone Pearl  
Mosaico Matte  
30x30 cm - 11<sup>1</sup>/<sub>4</sub>"x11<sup>1</sup>/<sub>4</sub>"

A7DJ Boost Stone Grey  
Mosaico Matte  
30x30 cm - 11<sup>1</sup>/<sub>4</sub>"x11<sup>1</sup>/<sub>4</sub>"

A7DK Boost Stone Smoke  
Mosaico Matte  
30x30 cm - 11<sup>1</sup>/<sub>4</sub>"x11<sup>1</sup>/<sub>4</sub>"

A7DM Boost Stone Tarmac  
Mosaico Matte  
30x30 cm - 11<sup>1</sup>/<sub>4</sub>"x11<sup>1</sup>/<sub>4</sub>"



A7DE Boost Stone Ivory  
Mosaico Matte  
30x30 cm - 11<sup>1</sup>/<sub>4</sub>"x11<sup>1</sup>/<sub>4</sub>"

A7DF Boost Stone Cream  
Mosaico Matte  
30x30 cm - 11<sup>1</sup>/<sub>4</sub>"x11<sup>1</sup>/<sub>4</sub>"

A7DG Boost Stone Clay  
Mosaico Matte  
30x30 cm - 11<sup>1</sup>/<sub>4</sub>"x11<sup>1</sup>/<sub>4</sub>"

A7DH Boost Stone Taupe  
Mosaico Matte  
30x30 cm - 11<sup>1</sup>/<sub>4</sub>"x11<sup>1</sup>/<sub>4</sub>"

A7DL Boost Stone Tobacco  
Mosaico Matte  
30x30 cm - 11<sup>1</sup>/<sub>4</sub>"x11<sup>1</sup>/<sub>4</sub>"



A67I Boost Stone White  
Mosaico Hex  
25x28,5 cm - 9<sup>7</sup>/<sub>8</sub>"x11<sup>1</sup>/<sub>4</sub>"

A7CY Boost Stone Pearl  
Mosaico Hex  
25x28,5 cm - 9<sup>7</sup>/<sub>8</sub>"x11<sup>1</sup>/<sub>4</sub>"

A7CZ Boost Stone Grey  
Mosaico Hex  
25x28,5 cm - 9<sup>7</sup>/<sub>8</sub>"x11<sup>1</sup>/<sub>4</sub>"

A7CØ Boost Stone Smoke  
Mosaico Hex  
25x28,5 cm - 9<sup>7</sup>/<sub>8</sub>"x11<sup>1</sup>/<sub>4</sub>"

A7C2 Boost Stone Tarmac  
Mosaico Hex  
25x28,5 cm - 9<sup>7</sup>/<sub>8</sub>"x11<sup>1</sup>/<sub>4</sub>"



A7CU Boost Stone Ivory  
Mosaico Hex  
25x28,5 cm - 9<sup>7</sup>/<sub>8</sub>"x11<sup>1</sup>/<sub>4</sub>"

A7CV Boost Stone Cream  
Mosaico Hex  
25x28,5 cm - 9<sup>7</sup>/<sub>8</sub>"x11<sup>1</sup>/<sub>4</sub>"

A7CW Boost Stone Clay  
Mosaico Hex  
25x28,5 cm - 9<sup>7</sup>/<sub>8</sub>"x11<sup>1</sup>/<sub>4</sub>"

A7CX Boost Stone Taupe  
Mosaico Hex  
25x28,5 cm - 9<sup>7</sup>/<sub>8</sub>"x11<sup>1</sup>/<sub>4</sub>"

A7C1 Boost Stone Tobacco  
Mosaico Hex  
25x28,5 cm - 9<sup>7</sup>/<sub>8</sub>"x11<sup>1</sup>/<sub>4</sub>"



A7DO Boost Stone  
Mosaico Cube Warm  
30x30 cm - 11<sup>1</sup>/<sub>4</sub>"x11<sup>1</sup>/<sub>4</sub>"  
 Warm:  
 Boost Stone Cream  
 Boost Stone Clay  
 Boost Stone Ivory  
 Boost Pro Ivory



A7DN Boost Stone  
Mosaico Cube Cold  
30x30 cm - 11<sup>1</sup>/<sub>4</sub>"x11<sup>1</sup>/<sub>4</sub>"  
 Cold:  
 Boost Stone Smoke  
 Boost Stone Grey  
 Boost Stone Pearl  
 Boost Pearl

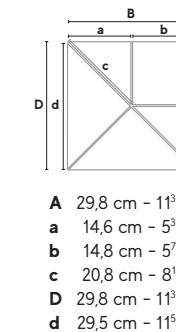
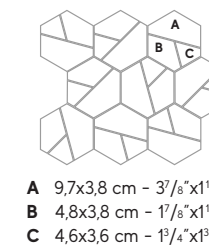
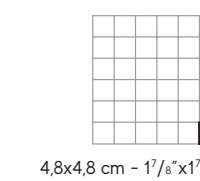

INDEX



A COMPLETE  
PRODUCT  
SYSTEM



PRODUCT  
FINDER



SURFACE  
RANGE



COMPANY



COLLECTIONS



3D WALL  
CONCRETE & RESIN LOOK  
METAL LOOK  
MARBLE LOOK  
STONE LOOK  
WOOD LOOK

LARGE SIZES



SLABS FOR  
COUNTERTOPS  
& FURNITURE



SINKS &  
BATHROOM  
FURNISHING



FACADES



TECHNICAL  
SPECIFICATIONS



# Brave



© Ceramiche Atlas Concorde



© Ceramiche Atlas Concorde



© Ceramiche Atlas Concorde

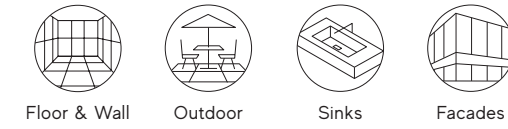

## Porcelain Tiles RECTIFIED MONOCALIBER

Sizes	Thickness	Surface finish
75x150 cm - 29 1/2" x 59"	± 9 mm	Matte Sensitech R10 B
75x75 cm - 29 1/2" x 29 1/2"	± 9 mm	Matte Sensitech R10 B
45x90 cm - 17 3/4" x 35 3/8"	± 9 mm	Matte Sensitech R10 B
60x60 cm - 23 5/8" x 23 5/8"	± 9 mm	Matte Sensitech R10 B
30x60 cm - 11 3/4" x 23 5/8"	± 9 mm	Matte Sensitech R10 B

### OUTDOOR AND WET AREAS

30x60 cm - 11 3/4" x 23 5/8"	± 9 mm	Grip R12 C
120x120 cm - 47 1/4" x 47 1/4"	± 20 mm	Outdoor R11 C
60x120 cm - 23 5/8" x 47 1/4"	± 20 mm	Outdoor R11 C
60x60 cm - 23 5/8" x 23 5/8"	± 20 mm	Outdoor R11 C



## Wall Tiles RECTIFIED MONOCALIBER

Sizes	Thickness	Surface finish
40x80 cm - 15 3/4" x 31 1/2"	± 8,5 mm	Matte
<b>3D WALL TILES</b>		
40x80 cm - 15 3/4" x 31 1/2"	± 10 mm	Matte



INDEX



A COMPLETE PRODUCT SYSTEM



PRODUCT FINDER



SURFACE RANGE



COMPANY



COLLECTIONS



3D WALL  
CONCRETE & RESIN LOOK  
METAL LOOK  
MARBLE LOOK  
STONE LOOK  
WOOD LOOK

LARGE SIZES



SLABS FOR COUNTERTOPS & FURNITURE



SINKS & BATHROOM FURNISHING



FACADES



TECHNICAL SPECIFICATIONS



# Brave

## Porcelain Tiles

### MATTE SURFACE



**± 9 mm**  
**75x150 cm** - 29 1/2" x 59"  
 A7G5 Brave Gypsum  
 A7G6 Brave Pearl  
 A7G7 Brave Grey  
 A7G8 Brave Earth  
 A7G9 Brave Coke



**± 9 mm**  
**75x75 cm** - 29 1/2" x 29 1/2"  
 AXAJ Brave Gypsum  
 AXAK Brave Pearl  
 AXAL Brave Grey  
 AXAM Brave Earth  
 AXAN Brave Coke



**± 9 mm**  
**60x60 cm** - 23 5/8" x 23 5/8"  
 AW9U Brave Gypsum  
 AW9V Brave Pearl  
 AW9W Brave Grey  
 AW9X Brave Earth  
 AW9Y Brave Coke



**± 9 mm**  
**30x60 cm** - 11 3/4" x 23 5/8"  
 DØ46 Brave Gypsum  
 DØ47 Brave Pearl  
 DØ48 Brave Grey  
 DØ49 Brave Earth  
 DØ5Ø Brave Coke



**± 9 mm**  
**45x90 cm** - 17 3/4" x 35 3/8"  
 AXAE Brave Gypsum  
 AXAF Brave Pearl  
 AXAG Brave Grey  
 AXAH Brave Earth  
 AXAI Brave Coke

### GRIP SURFACE



**± 9 mm**  
**30x60 cm** - 11 3/4" x 23 5/8"  
 DØ51 Brave Gypsum Grip  
 DØ52 Brave Pearl Grip  
 DØ53 Brave Grey Grip  
 DØ54 Brave Earth Grip  
 DØ55 Brave Coke Grip

### OUTDOOR ± 20 mm

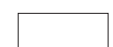

**± 20 mm**  
**120x120 cm** - 47 1/4" x 47 1/4"  
 AOX9 Brave Grey 20 mm  
 AOYA Brave Coke 20 mm



**± 20 mm**  
**60x120 cm** - 23 5/8" x 47 1/4"  
 AT5I Brave Gypsum 20 mm  
 AT5J Brave Pearl 20 mm  
 AT5K Brave Grey 20 mm  
 AT5L Brave Earth 20 mm  
 AT5M Brave Coke 20 mm



**± 20 mm**  
**60x60 cm** - 23 5/8" x 23 5/8"  
 AXAT Brave Gypsum 20 mm  
 AXAU Brave Pearl 20 mm  
 AXAV Brave Grey 20 mm  
 AXAW Brave Earth 20 mm  
 AXAX Brave Coke 20 mm

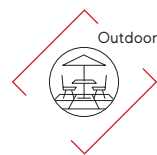

GYPSUM



PEARL



EARTH

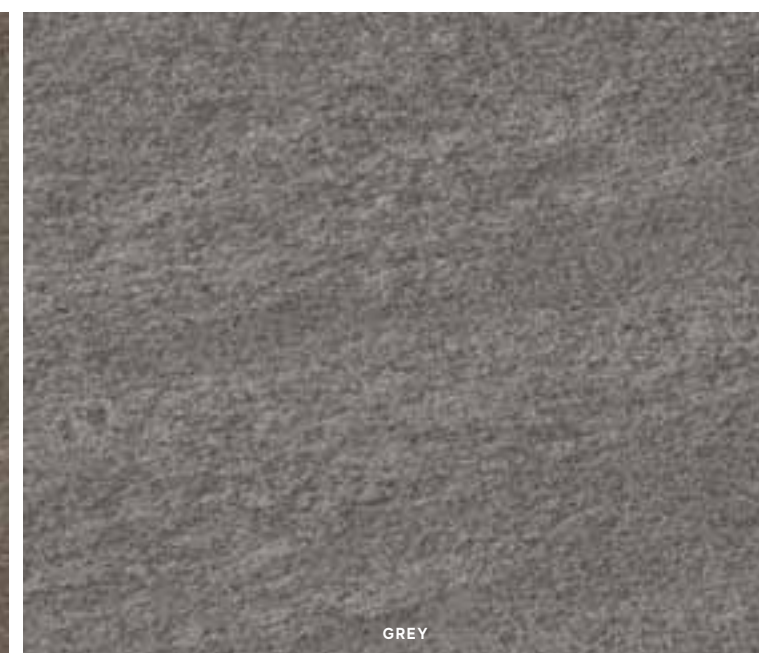

GREY



COKE

### TRIM TILES

p. 352

	Battiscopa	Gradino *	Scalino *	Scalino *	Scalino Ang.*	Battiscopa Sag. Scala *	Elemento L *
	7,2x60 2 7/8" x 23 5/8"	30x60 11 3/4" x 23 5/8"	33x150 13" x 59"	33x90 13" x 35 3/8"	33x75 13" x 29 1/2"	33x60 13" x 23 5/8"	33x33 - 13" x 13"
	Matte	Matte	Matte	Matte	Matte	Matte	Matte
Gypsum	A1IE	A1IJ	AZT9	A1IP	A1IU	A1IZ	DX A1JA
Pearl	A1IF	A1IL	AZUA	A1IQ	A1IV	A1IØ	SX A1IA
Grey	A1IG	A1IM	A1ZQ	A1IR	A1IW	A1I1	A1JK A1JL
Earth	A1IH	A1IN	AZUB	A1IS	A1IX	A1I2	A1JG A1JH
Coke	A1II	A1IO	AZEW	A1IT	A1IY	A1I3	A1JN A1JU
							A1JØ A1J1

\* These parts are supplied to order - I pezzi sono disponibili su ordinazione - Les pièces sont disponibles sur commande - Die Teile sind auf Bestellung lieferbar - Las piezas se hacen por encargo - Изготавливаются на заказ

### COMPLETE YOUR PROJECT

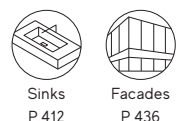

A COMPLETE PRODUCT SYSTEM >

PRODUCT FINDER >

SURFACE RANGE >

COMPANY >

COLLECTIONS >

3D WALL  
 CONCRETE & RESIN LOOK  
 METAL LOOK  
 MARBLE LOOK  
 STONE LOOK  
 WOOD LOOK

LARGE SIZES >

SLABS FOR COUNTERTOPS & FURNITURE >

SINKS & BATHROOM FURNISHING >

FACADES >

TECHNICAL SPECIFICATIONS >

# Brave

## Porcelain Tiles

### DECOR RANGE



A1FW Brave Gypsum  
Industrial 3D <sup>(1)</sup>  
44x28,5 - 1<sup>7</sup>/<sub>8</sub>"x11<sup>1</sup>/<sub>4</sub>"



A1FY Brave Grey  
Industrial 3D <sup>(1)</sup>  
44x28,5 - 1<sup>7</sup>/<sub>8</sub>"x11<sup>1</sup>/<sub>4</sub>"



A1FØ Brave Coke  
Industrial 3D <sup>(1)</sup>  
44x28,5 - 1<sup>7</sup>/<sub>8</sub>"x11<sup>1</sup>/<sub>4</sub>"

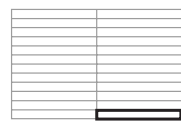

2,4x22 cm - 1"x8<sup>5</sup>/<sub>8</sub>"



A1FX Brave Pearl  
Industrial 3D <sup>(1)</sup>  
44x28,5 - 1<sup>7</sup>/<sub>8</sub>"x11<sup>1</sup>/<sub>4</sub>"



A1FZ Brave Earth  
Industrial 3D <sup>(1)</sup>  
44x28,5 - 1<sup>7</sup>/<sub>8</sub>"x11<sup>1</sup>/<sub>4</sub>"



A1FM Brave Gypsum  
Mosaico  
30x30 - 1<sup>1</sup>/<sub>4</sub>"x1<sup>1</sup>/<sub>4</sub>"



A1FO Brave Grey  
Mosaico  
30x30 - 1<sup>1</sup>/<sub>4</sub>"x1<sup>1</sup>/<sub>4</sub>"



A1FQ Brave Coke  
Mosaico  
30x30 - 1<sup>1</sup>/<sub>4</sub>"x1<sup>1</sup>/<sub>4</sub>"



A1FN Brave Pearl  
Mosaico  
30x30 - 1<sup>1</sup>/<sub>4</sub>"x1<sup>1</sup>/<sub>4</sub>"



A1FP Brave Earth  
Mosaico  
30x30 - 1<sup>1</sup>/<sub>4</sub>"x1<sup>1</sup>/<sub>4</sub>"

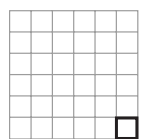

4,8x4,8 cm - 1<sup>7</sup>/<sub>8</sub>"x1<sup>7</sup>/<sub>8</sub>"



A1F1 Brave Gypsum  
Brick 3D <sup>(1)</sup>  
29x59 - 1<sup>1</sup>/<sub>8</sub>"x23<sup>3</sup>/<sub>4</sub>"



A1F2 Brave Pearl  
Brick 3D <sup>(1)</sup>  
29x59 - 1<sup>1</sup>/<sub>8</sub>"x23<sup>3</sup>/<sub>4</sub>"

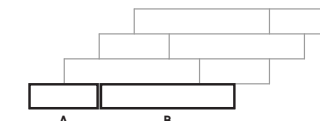

A 19,9x7,1 cm - 7<sup>7</sup>/<sub>8</sub>"x2<sup>7</sup>/<sub>8</sub>"  
B 38,6x7,1 cm - 15<sup>1</sup>/<sub>8</sub>"x2<sup>7</sup>/<sub>8</sub>"



A1F3 Brave Grey  
Brick 3D <sup>(1)</sup>  
29x59 - 1<sup>1</sup>/<sub>8</sub>"x23<sup>3</sup>/<sub>4</sub>"



A1F4 Brave Earth  
Brick 3D <sup>(1)</sup>  
29x59 - 1<sup>1</sup>/<sub>8</sub>"x23<sup>3</sup>/<sub>4</sub>"



A1F5 Brave Coke  
Brick 3D <sup>(1)</sup>  
29x59 - 1<sup>1</sup>/<sub>8</sub>"x23<sup>3</sup>/<sub>4</sub>"

<sup>(1)</sup> Multi-thickness mosaic, close joint installation without grouting. - Mosaico multispessore, posa senza stuccatura a giunto unito - Mosaïque multi-épaisseur, pose sans mastic avec joint nul. - Mosaik mit verschieden Stärken, fugenlose Verlegung ohne Mörtel. - Mosaico multiespesor, colocación sin mástico y sin juntas. - Мозаика разной толщины, укладка встык без затирки швов.

The decoration can only be laid on the wall - Il decoro si può posare solo a rivestimento - Décor uniquement mural - Das Dekor kann nur an der Wand verlegt werden. La decoración se puede colocar únicamente en paredes - Декор может быть уложен только на стену.

INDEX



A COMPLETE  
PRODUCT  
SYSTEM



PRODUCT  
FINDER



SURFACE  
RANGE



COMPANY



COLLECTIONS



3D WALL  
CONCRETE & RESIN LOOK  
METAL LOOK  
MARBLE LOOK  
STONE LOOK  
WOOD LOOK

LARGE SIZES



SLABS FOR  
COUNTERTOPS  
& FURNITURE



SINKS &  
BATHROOM  
FURNISHING



FACADES



TECHNICAL  
SPECIFICATIONS







# Brave

## Wall Tiles

### MATTE SURFACE

 **± 8,5 mm**  
**40x80 cm** - 15<sup>7</sup>/<sub>4</sub>"x31<sup>1</sup>/<sub>2</sub>"  
 8BWU Brave Gypsum  
 8BWL Brave Pearl  
 8BWY Brave Grey

 **± 10 mm 3D WALL**  
**40x80 cm** - 15<sup>7</sup>/<sub>4</sub>"x31<sup>1</sup>/<sub>2</sub>"  
 8BDG Brave 3D Wave Gypsum  
 8BDP Brave 3D Wave Pearl  
 8BDE Brave 3D Wave Grey  
 8BBG Brave 3D Blade Gypsum

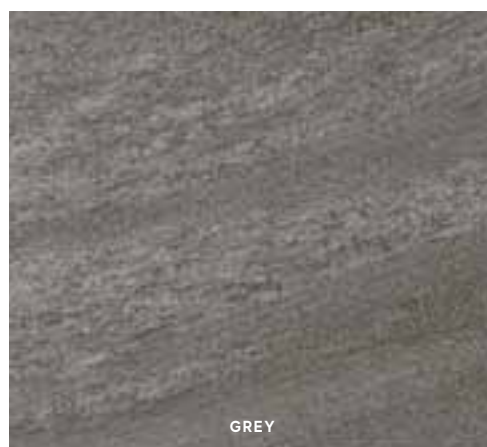
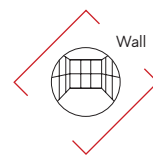

### TRIM TILES

LBSU Brave Gypsum Spigolo 0,8  
 0,8x20 cm - 3<sup>1</sup>/<sub>8</sub>"x7<sup>7</sup>/<sub>8</sub>"

A1BU Brave Gypsum Spigolo 0,8 A.E.  
 0,8x0,8 cm - 3<sup>1</sup>/<sub>8</sub>"x3<sup>1</sup>/<sub>8</sub>"

LBSL Brave Pearl Spigolo 0,8  
 0,8x20 cm - 3<sup>1</sup>/<sub>8</sub>"x7<sup>7</sup>/<sub>8</sub>"

A1BL Brave Pearl Spigolo 0,8 A.E.  
 0,8x0,8 cm - 3<sup>1</sup>/<sub>8</sub>"x3<sup>1</sup>/<sub>8</sub>"

LBSE Brave Grey Spigolo 0,8  
 0,8x20 cm - 3<sup>1</sup>/<sub>8</sub>"x7<sup>7</sup>/<sub>8</sub>"

A1BR Brave Grey Spigolo 0,8 A.E.  
 0,8x0,8 cm - 3<sup>1</sup>/<sub>8</sub>"x3<sup>1</sup>/<sub>8</sub>"

### 3D TRIM TILES

LB1G Brave Gypsum Spigolo 10mm \* (1)  
 1x20 cm - 3<sup>1</sup>/<sub>8</sub>"x7<sup>7</sup>/<sub>8</sub>"

LB1R Brave Pearl Spigolo 10mm \* (1)  
 1x20 cm - 3<sup>1</sup>/<sub>8</sub>"x7<sup>7</sup>/<sub>8</sub>"

LB1E Brave Grey Spigolo 10mm \* (1)  
 1x20 cm - 3<sup>1</sup>/<sub>8</sub>"x7<sup>7</sup>/<sub>8</sub>"

\* These parts are supplied to order - I pezzi sono disponibili su ordinazione - Les pièces sont disponibles sur commande - Die Teile sind auf Bestellung lieferbar - Las piezas se hacen por encargo - Изготавливаются на заказ

(1) The 10 mm edge matches three-dimensional wall tiles having a 10-11 mm thickness - Lo spigolo 10 mm si abbina a rivestimenti tridimensionali di spessore 10-11 mm - Le bord 10 mm s'adapte aux revêtements tridimensionnels épaisseur 10-11 mm - Die 10 mm Kante ist mit dreidimensionalen Wandfliesen mit einer Dicke von 10-11 mm kombinierbar - La arista de 10 mm se combina con revestimientos tridimensionales de 10-11 mm de grosor - Угловой элемент 10 мм сочетается с трехмерной настенной плиткой толщиной 10-11 мм

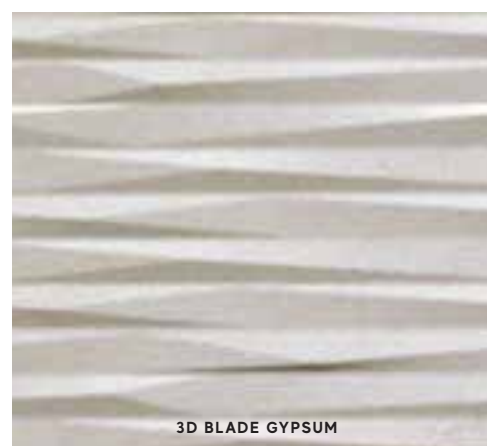

### DECOR RANGE



9BBG Brave Gypsum Mosaic  
 30,5x30,5 - 12"x12"



9BBP Brave Pearl Mosaic  
 30,5x30,5 - 12"x12"



9BBE Brave Grey Mosaic  
 30,5x30,5 - 12"x12"

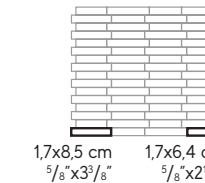

© Ceramiche Atlas Concorde

INDEX



A COMPLETE PRODUCT SYSTEM



PRODUCT FINDER



SURFACE RANGE



COMPANY



COLLECTIONS



3D WALL  
 CONCRETE & RESIN LOOK  
 METAL LOOK  
 MARBLE LOOK  
 STONE LOOK  
 WOOD LOOK

LARGE SIZES



SLABS FOR COUNTERTOPS & FURNITURE



SINKS & BATHROOM FURNISHING



FACADES



TECHNICAL SPECIFICATIONS



# Klif



© Ceramiche Atlas Concorde



© Ceramiche Atlas Concorde



© Ceramiche Atlas Concorde

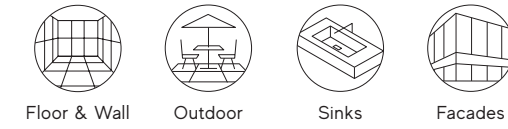

Floor & Wall

Outdoor

Sinks

Facades

## Porcelain Tiles RECTIFIED MONOCALIBER

Sizes	Thickness	Surface finish
75x150 cm - 29 1/2" x 59"	± 9 mm	Matte Sensitech R10 B
75x75 cm - 29 1/2" x 29 1/2"	± 9 mm	Matte Sensitech R10 B
37,5x75 cm - 14 3/4" x 29 1/2"	± 9 mm	Matte Sensitech R10 B

### OUTDOOR AND WET AREAS

37,5x75 cm - 14 3/4" x 29 1/2"	± 9 mm	Grip R11 C
--------------------------------	--------	------------

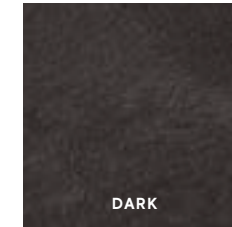

INDEX



A COMPLETE PRODUCT SYSTEM



PRODUCT FINDER



SURFACE RANGE



COMPANY



COLLECTIONS



- 3D WALL
- CONCRETE & RESIN LOOK
- METAL LOOK
- MARBLE LOOK
- STONE LOOK
- WOOD LOOK

LARGE SIZES



SLABS FOR COUNTERTOPS & FURNITURE



SINKS & BATHROOM FURNISHING



FACADES



TECHNICAL SPECIFICATIONS



# Klif

## Porcelain Tiles

### MATTE SURFACE



± 9 mm  
**75x150 cm** - 29 1/2" x 59"  
 A7HJ Klif White  
 A7HK Klif Silver  
 A7HL Klif Grey  
 A7HM Klif Dark



± 9 mm  
**75x75 cm** - 29 1/2" x 29 1/2"  
 ANXS Klif White  
 ANXT Klif Silver  
 ANXU Klif Grey  
 ANXV Klif Dark

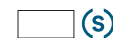

± 9 mm  
**37,5x75 cm** - 14 3/4" x 29 1/2"  
 ANXW Klif White  
 ANXX Klif Silver  
 ANXY Klif Grey  
 ANXZ Klif Dark

### GRIP SURFACE



± 9 mm  
**37,5x75 cm** - 14 3/4" x 29 1/2"  
 ANXØ Klif White Grip  
 ANX1 Klif Silver Grip  
 ANX2 Klif Grey Grip  
 ANX3 Klif Dark Grip

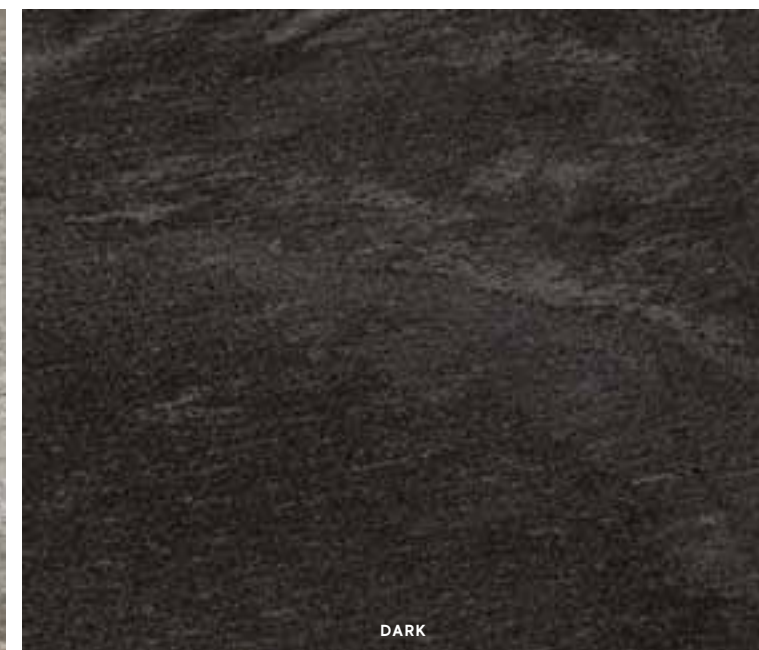
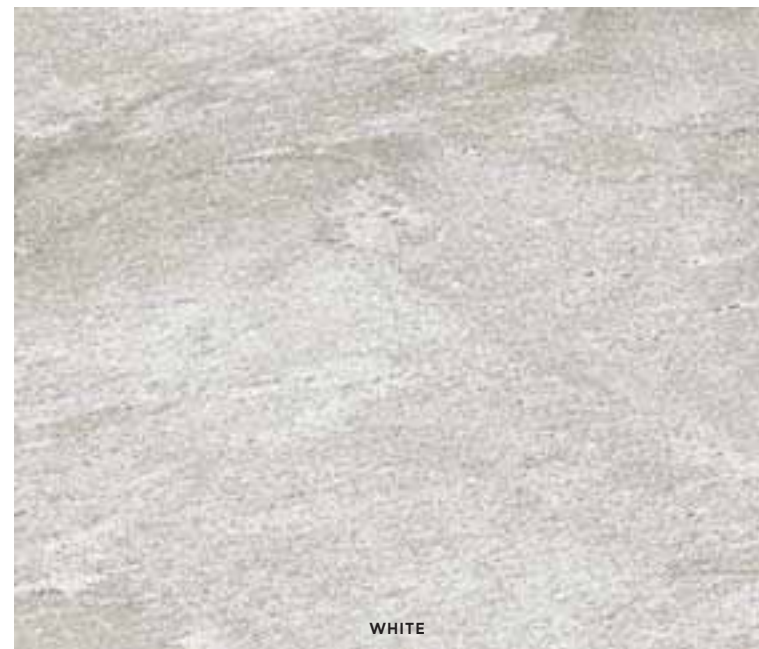
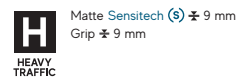

### TRIM TILES

p. 352

	Battiscopa	Gradino *	Scalino *	Scalino *	Scalino Ang.*	Battiscopa Sag. Scala *	Elemento L
	7,2x75 cm 2 7/8" x 29 1/2" Matte	37,5x75 cm 14 1/4" x 29 1/2" Matte	37,5x150 cm 14 3/4" x 59" Matte	37,5x75 cm 14 3/4" x 29 1/2" Matte	37,5x37,5 cm 14 3/4" x 14 3/4" Matte	7,2x30 cm 2 7/8" x 11 7/8" Matte	15x75 H 4 cm 5 7/8" x 29 1/2" H: 1 5/8" Grip
White	AN4F	AN4P	AN4T	AN4X	AN42	DX AN4H	AN5A
Silver	AN2R	AN4Q	AN4U	AN4Y	AN43	AN4I	AN5B
Grey	AN2S	AMG4	AN4V	AN4Z	AN44	AN4J	AN5C
Dark	AN4G	AN4S	AN4W	AN41	AN45	AN4K	AN5D
						SX AN4L	
							AN4M
							AN4N
							AN5D

\* These parts are supplied to order - I pezzi sono disponibili su ordinazione - Les pièces sont disponibles sur commande - Die Teile sind auf Bestellung lieferbar - Las piezas se hacen por encargo - Изготавливаются на заказ

### COMPLETE YOUR PROJECT

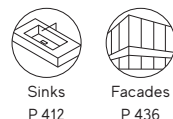

A COMPLETE PRODUCT SYSTEM >

PRODUCT FINDER >

SURFACE RANGE >

COMPANY >

COLLECTIONS >

3D WALL  
 CONCRETE & RESIN LOOK  
 METAL LOOK  
 MARBLE LOOK  
 STONE LOOK  
 WOOD LOOK

LARGE SIZES >

SLABS FOR COUNTERTOPS & FURNITURE >

SINKS & BATHROOM FURNISHING >

FACADES >

TECHNICAL SPECIFICATIONS >

# Klif

## Porcelain Tiles

### DECOR RANGE



AN46 Klif White  
Mosaico  
30x30 - 1<sup>1</sup>/<sub>4</sub>"x1<sup>1</sup>/<sub>4</sub>"



AN47 Klif Silver  
Mosaico  
30x30 - 1<sup>1</sup>/<sub>4</sub>"x1<sup>1</sup>/<sub>4</sub>"



AN48 Klif Grey  
Mosaico  
30x30 - 1<sup>1</sup>/<sub>4</sub>"x1<sup>1</sup>/<sub>4</sub>"



AN49 Klif Dark  
Mosaico  
30x30 - 1<sup>1</sup>/<sub>4</sub>"x1<sup>1</sup>/<sub>4</sub>"

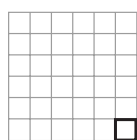

4,8x4,8 cm - 1<sup>7</sup>/<sub>8</sub>"x1<sup>7</sup>/<sub>8</sub>"



AN7G Klif White  
Triangles  
28,5x33 - 11<sup>1</sup>/<sub>4</sub>"x13"



AN7H Klif Silver  
Triangles  
28,5x33 - 11<sup>1</sup>/<sub>4</sub>"x13"



AN7I Klif Grey  
Triangles  
28,5x33 - 11<sup>1</sup>/<sub>4</sub>"x13"



AN7J Klif Dark  
Triangles  
28,5x33 - 11<sup>1</sup>/<sub>4</sub>"x13"

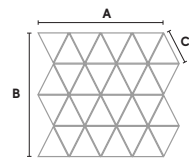

A 32,8 cm - 13"  
B 28,5 cm - 11<sup>1</sup>/<sub>4</sub>"  
C 7,9 cm - 3<sup>1</sup>/<sub>8</sub>"



AN7C Klif White  
Brick  
37,5x75 - 14<sup>3</sup>/<sub>4</sub>"x29<sup>1</sup>/<sub>2</sub>"



AN7D Klif Silver  
Brick  
37,5x75 - 14<sup>3</sup>/<sub>4</sub>"x29<sup>1</sup>/<sub>2</sub>"

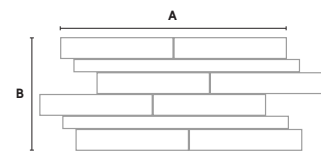

A 74,8 cm - 29<sup>1</sup>/<sub>2</sub>"  
B 37,4 cm - 14<sup>3</sup>/<sub>4</sub>"



AN7E Klif Grey  
Brick  
37,5x75 - 14<sup>3</sup>/<sub>4</sub>"x29<sup>1</sup>/<sub>2</sub>"



AN7F Klif Dark  
Brick  
37,5x75 - 14<sup>3</sup>/<sub>4</sub>"x29<sup>1</sup>/<sub>2</sub>"



AN7K Klif White  
Brick 3D <sup>(1)</sup>  
28x55 - 11"x21<sup>1</sup>/<sub>8</sub>"



AN7L Klif Silver  
Brick 3D <sup>(1)</sup>  
28x55 - 11"x21<sup>1</sup>/<sub>8</sub>"

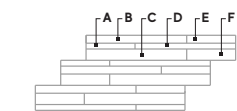

A 18x2,1 cm - 7<sup>1</sup>/<sub>8</sub>"x1<sup>1</sup>/<sub>8</sub>"  
B 37x2,9 cm - 14<sup>3</sup>/<sub>8</sub>"x1<sup>1</sup>/<sub>8</sub>"  
C 37x4,2 cm - 14<sup>5</sup>/<sub>8</sub>"x1<sup>1</sup>/<sub>8</sub>"  
D 37x2,1 cm - 14<sup>5</sup>/<sub>8</sub>"x1<sup>1</sup>/<sub>8</sub>"  
E 18x2,9 cm - 7<sup>1</sup>/<sub>8</sub>"x1<sup>1</sup>/<sub>8</sub>"  
F 18x4,2 cm - 7<sup>1</sup>/<sub>8</sub>"x1<sup>1</sup>/<sub>8</sub>"



AN7M Klif Grey  
Brick 3D <sup>(1)</sup>  
28x55 - 11"x21<sup>1</sup>/<sub>8</sub>"



AN7N Klif Dark  
Brick 3D <sup>(1)</sup>  
28x55 - 11"x21<sup>1</sup>/<sub>8</sub>"

INDEX



A COMPLETE  
PRODUCT  
SYSTEM



PRODUCT  
FINDER



SURFACE  
RANGE



COMPANY



COLLECTIONS



3D WALL  
CONCRETE & RESIN LOOK  
METAL LOOK  
MARBLE LOOK  
STONE LOOK  
WOOD LOOK

LARGE SIZES



SLABS FOR  
COUNTERTOPS  
& FURNITURE



SINKS &  
BATHROOM  
FURNISHING



FACADES



TECHNICAL  
SPECIFICATIONS



<sup>(1)</sup> Multi-thickness mosaic, close joint installation without grouting. - Mosaico multispessore, posa senza stuccatura a giunto unito. - Mosaïque multi-épaisseur, pose sans mastic avec joint nul. - Mosaik mit verschieden Stärken, fugenlose Verlegung ohne Mörtel. - Mosaico multiespesor, colocación sin mástique y sin juntas. - Мозаика разной толщины; укладка встык без затирки швов.

The decoration can only be laid on the wall - Il decoro si può posare solo a rivestimento - Décor uniquement mural - Das Dekor kann nur an der Wand verlegt werden - La decoración se puede colocar únicamente en paredes - Декор может быть уложен только на стену.

# Kone



© Ceramiche Atlas Concorde

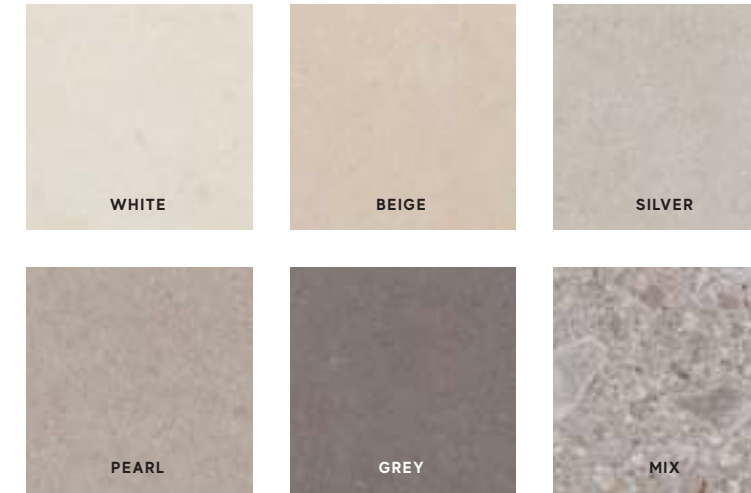

## Porcelain Tiles RECTIFIED MONOCALIBER

Sizes	Thickness	Surface finish
120x120 cm - 47 <sup>1</sup> / <sub>4</sub> "x47 <sup>1</sup> / <sub>4</sub> "	± 9 mm	Matte Sensitech R10 B
75x150 cm - 29 <sup>1</sup> / <sub>2</sub> "x59"	± 9 mm	Matte Sensitech R10 B
75x75 cm - 29 <sup>1</sup> / <sub>2</sub> "x29 <sup>1</sup> / <sub>2</sub> "	± 9 mm	Matte Sensitech R10 B
60x60 cm - 23 <sup>5</sup> / <sub>8</sub> "x23 <sup>5</sup> / <sub>8</sub> "	± 9 mm	Matte Sensitech R10 B
30x60 cm - 11 <sup>3</sup> / <sub>4</sub> "x23 <sup>5</sup> / <sub>8</sub> "	± 9 mm	Matte Sensitech R10 B

### LARGE SIZES P. 356

OUTDOOR AND WET AREAS	Thickness	Surface finish
30x60 cm - 11 <sup>3</sup> / <sub>4</sub> "x23 <sup>5</sup> / <sub>8</sub> "	± 9 mm	Grip R11 B

### atlasPLAN

SLABS FOR COUNTERTOPS & FURNITURE	Thickness	Surface finish
162x324 cm - 63 <sup>3</sup> / <sub>4</sub> "x127 <sup>1</sup> / <sub>2</sub> " NON-RECTIFIED	± 6-12 mm	Hammered



© Ceramiche Atlas Concorde



© Ceramiche Atlas Concorde

INDEX



A COMPLETE PRODUCT SYSTEM >

PRODUCT FINDER >

SURFACE RANGE >

COMPANY >

COLLECTIONS >

- 3D WALL
- CONCRETE & RESIN LOOK
- METAL LOOK
- MARBLE LOOK
- STONE LOOK
- WOOD LOOK

LARGE SIZES >

SLABS FOR COUNTERTOPS & FURNITURE >

SINKS & BATHROOM FURNISHING >

FACADES >

TECHNICAL SPECIFICATIONS >

# Kone

## Porcelain Tiles

### MATTE SURFACE



**± 9 mm**  
**120x120 cm** - 47<sup>1</sup>/<sub>4</sub>"x47<sup>1</sup>/<sub>4</sub>"  
 AULO Kone White  
 AULP Kone Pearl  
 AULQ Kone Grey



**± 9 mm**  
**60x60 cm** - 23<sup>5</sup>/<sub>8</sub>"x23<sup>5</sup>/<sub>8</sub>"  
 AUK8 Kone White  
 AUK9 Kone Beige  
 AULA Kone Silver  
 AULB Kone Pearl  
 AULC Kone Grey



**± 9 mm**  
**30x60 cm** - 11<sup>7</sup>/<sub>4</sub>"x23<sup>5</sup>/<sub>8</sub>"  
 D216 Kone White  
 D217 Kone Beige  
 D218 Kone Silver  
 D219 Kone Pearl  
 D220 Kone Grey

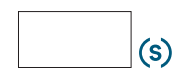

**± 9 mm**  
**75x150 cm** - 29<sup>1</sup>/<sub>2</sub>"x59"  
 A7HN Kone White  
 A7HO Kone Beige  
 A7HP Kone Silver  
 A7HQ Kone Pearl  
 A7HR Kone Grey  
 A7HS Kone Mix



**± 9 mm**  
**75x75 cm** - 29<sup>1</sup>/<sub>2</sub>"x29<sup>1</sup>/<sub>2</sub>"  
 AUKT Kone White  
 AUKU Kone Beige  
 AUKV Kone Silver  
 AUKW Kone Pearl  
 AUKX Kone Grey

### GRIP SURFACE



**± 9 mm**  
**30x60 cm** - 11<sup>7</sup>/<sub>4</sub>"x23<sup>5</sup>/<sub>8</sub>"  
 D221 Kone White Grip  
 D222 Kone Beige Grip  
 D223 Kone Silver Grip  
 D224 Kone Pearl Grip  
 D225 Kone Grey Grip

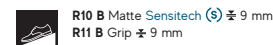

### TRIM TILES

p. 352

#### Battiscopa

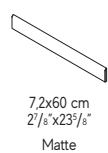

7,2x60 cm  
 2<sup>7</sup>/<sub>8</sub>"x23<sup>5</sup>/<sub>8</sub>"  
 Matte

White  
 Beige  
 Silver  
 Pearl  
 Grey

#### Gradino \*



30x60 cm  
 11<sup>1</sup>/<sub>4</sub>"x23<sup>5</sup>/<sub>8</sub>"  
 Matte

#### Scalino \*

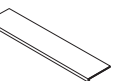

33x150 cm  
 13"x59"

#### Scalino \*

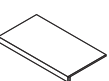

33x75 cm  
 13"x29<sup>1</sup>/<sub>2</sub>"

#### Scalino \*



33x60 cm  
 13"x23<sup>5</sup>/<sub>8</sub>"

#### Scalino Ang.\*

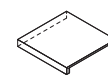

33x33 cm  
 13"x13"

#### Battiscopa Sag. Scala \*



7,2x30 cm  
 2<sup>7</sup>/<sub>8</sub>"x11<sup>1</sup>/<sub>4</sub>"  
 Matte

#### Elemento L \*

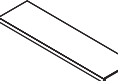

15x60 H. 4 cm  
 5<sup>7</sup>/<sub>8</sub>"x23<sup>5</sup>/<sub>8</sub>" H. 1<sup>1</sup>/<sub>4</sub>"  
 Grip

DX	SX
AUO3	AUOY
AUO4	AUOZ
AUO5	AUOØ
AUO6	AUO1
AUO7	AUO2

\* These parts are supplied to order - I pezzi sono disponibili su ordinazione - Les pièces sont disponibles sur commande - Die Teile sind auf Bestellung lieferbar - Las piezas se hacen por encargo - Изготавливаются на заказ

### COMPLETE YOUR PROJECT

Countertops  
P.402  
162x324 cm  
NON-RECTIFIED

Sinks  
P.412

Facades  
P.436

INDEX



A COMPLETE  
PRODUCT  
SYSTEM



PRODUCT  
FINDER



SURFACE  
RANGE



COMPANY



COLLECTIONS



3D WALL  
CONCRETE & RESIN LOOK  
METAL LOOK  
MARBLE LOOK  
STONE LOOK  
WOOD LOOK

LARGE SIZES



SLABS FOR  
COUNTERTOPS  
& FURNITURE



SINKS &  
BATHROOM  
FURNISHING



FACADES



TECHNICAL  
SPECIFICATIONS



# Kone

## Porcelain Tiles

### DECOR RANGE

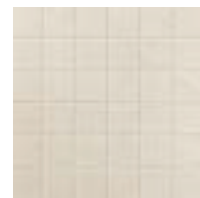

AUNR Kone White Mosaico  
30x30 - 1<sup>1</sup>/<sub>4</sub>"x1<sup>1</sup>/<sub>4</sub>"



AUNS Kone Beige Mosaico  
30x30 - 1<sup>1</sup>/<sub>4</sub>"x1<sup>1</sup>/<sub>4</sub>"



AUNT Kone Silver Mosaico  
30x30 - 1<sup>1</sup>/<sub>4</sub>"x1<sup>1</sup>/<sub>4</sub>"



AUNU Kone Pearl Mosaico  
30x30 - 1<sup>1</sup>/<sub>4</sub>"x1<sup>1</sup>/<sub>4</sub>"

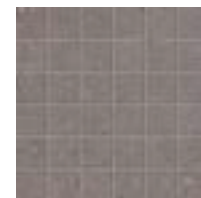

AUNV Kone Grey Mosaico  
30x30 - 1<sup>1</sup>/<sub>4</sub>"x1<sup>1</sup>/<sub>4</sub>"

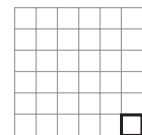

4,8x4,8 cm - 1<sup>7</sup>/<sub>8</sub>"x1<sup>7</sup>/<sub>8</sub>"



AUN9 Kone White Mosaico Pinnacle 3D <sup>(1)</sup>  
30x30 - 1<sup>1</sup>/<sub>4</sub>"x1<sup>1</sup>/<sub>4</sub>"



AUAO Kone Beige Mosaico Pinnacle 3D <sup>(1)</sup>  
30x30 - 1<sup>1</sup>/<sub>4</sub>"x1<sup>1</sup>/<sub>4</sub>"



AUOB Kone Silver Mosaico Pinnacle 3D <sup>(1)</sup>  
30x30 - 1<sup>1</sup>/<sub>4</sub>"x1<sup>1</sup>/<sub>4</sub>"

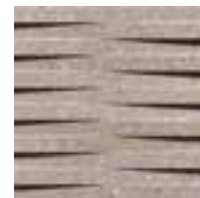

AUOC Kone Pearl Mosaico Pinnacle 3D <sup>(1)</sup>  
30x30 - 1<sup>1</sup>/<sub>4</sub>"x1<sup>1</sup>/<sub>4</sub>"

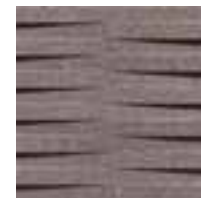

AUOD Kone Grey Mosaico Pinnacle 3D <sup>(1)</sup>  
30x30 - 1<sup>1</sup>/<sub>4</sub>"x1<sup>1</sup>/<sub>4</sub>"



29,6x2,5 cm - 1<sup>1</sup>/<sub>8</sub>"x1"



AUNW Kone White Brick  
30x60 - 1<sup>1</sup>/<sub>4</sub>"x2<sup>3</sup>/<sub>8</sub>"



AUNZ Kone Pearl Brick  
30x60 - 1<sup>1</sup>/<sub>4</sub>"x2<sup>3</sup>/<sub>8</sub>"

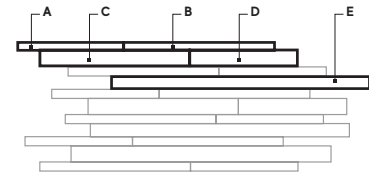

**A** 2,1x24,8 cm - 3<sup>1</sup>/<sub>4</sub>"x9<sup>3</sup>/<sub>4</sub>"  
**B** 2,1x34,5 cm - 3<sup>1</sup>/<sub>4</sub>"x13<sup>3</sup>/<sub>8</sub>"  
**C** 3,3x34,5 cm - 1<sup>1</sup>/<sub>4</sub>"x13<sup>3</sup>/<sub>8</sub>"  
**D** 3,3x24,8 cm - 1<sup>1</sup>/<sub>4</sub>"x9<sup>3</sup>/<sub>4</sub>"  
**E** 2,5x60 cm - 1"x2<sup>3</sup>/<sub>8</sub>"



AUNX Kone Beige Brick  
30x60 - 1<sup>1</sup>/<sub>4</sub>"x2<sup>3</sup>/<sub>8</sub>"



AUNØ Kone Grey Brick  
30x60 - 1<sup>1</sup>/<sub>4</sub>"x2<sup>3</sup>/<sub>8</sub>"



AUNY Kone Silver Brick  
30x60 - 1<sup>1</sup>/<sub>4</sub>"x2<sup>3</sup>/<sub>8</sub>"



AUOO Kone White Chevron  
11,5x67 - 4<sup>1</sup>/<sub>2</sub>"x26<sup>3</sup>/<sub>8</sub>"



AUOR Kone Pearl Chevron  
11,5x67 - 4<sup>1</sup>/<sub>2</sub>"x26<sup>3</sup>/<sub>8</sub>"



AUOP Kone Beige Chevron  
11,5x67 - 4<sup>1</sup>/<sub>2</sub>"x26<sup>3</sup>/<sub>8</sub>"



AUOS Kone Grey Chevron  
11,5x67 - 4<sup>1</sup>/<sub>2</sub>"x26<sup>3</sup>/<sub>8</sub>"



AUOQ Kone Silver Chevron  
11,5x67 - 4<sup>1</sup>/<sub>2</sub>"x26<sup>3</sup>/<sub>8</sub>"

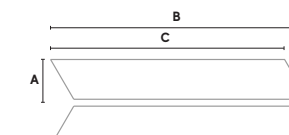

**A** 11,5 cm - 4<sup>1</sup>/<sub>2</sub>"  
**B** 73,4 cm - 28<sup>7</sup>/<sub>8</sub>"  
**C** 67 cm - 26<sup>3</sup>/<sub>8</sub>"

<sup>(1)</sup> Multi-thickness mosaic, close joint installation without grouting. - Mosaico multispessore, posa senza stuccatura a giunto unito. - Mosaïque multi-épaisseur, pose sans mastic avec joint nul. - Mosaik mit verschieden Stärken, fugenlose Verlegung ohne Mörtel. - Mosaico multiespesor, colocación sin mástico y sin juntas. - Мозаика разной толщины, укладка встык без затирки швов.

The decoration can only be laid on the wall - Il decoro si può posare solo a rivestimento - Décor uniquement mural - Das Dekor kann nur an der Wand verlegt werden. La decoración se puede colocar únicamente en paredes - Декор может быть уложен только на стену.

# Lims



© Ceramiche Atlas Concorde



© Ceramiche Atlas Concorde



© Ceramiche Atlas Concorde

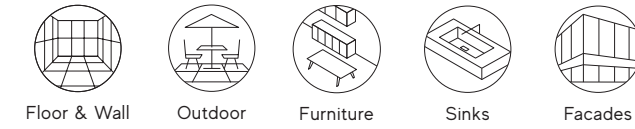

## Porcelain Tiles RECTIFIED MONOCALIBER

Sizes	Thickness	Surface finish
120x278 cm - 47 <sup>1</sup> / <sub>4</sub> "x109 <sup>1</sup> / <sub>2</sub> "	± 6 mm	Matte <b>R9 A</b>
120x120 cm - 47 <sup>1</sup> / <sub>4</sub> "x47 <sup>1</sup> / <sub>4</sub> "	± 9 mm	Matte <b>Sensitech R10 B</b>
75x150 cm - 29 <sup>1</sup> / <sub>2</sub> "x59"	± 9 mm	Matte <b>Sensitech R10 B</b>
75x75 cm - 29 <sup>1</sup> / <sub>2</sub> "x29 <sup>1</sup> / <sub>2</sub> "	± 9 mm	Matte <b>Sensitech R10 B</b>
37,5x75 cm - 14 <sup>3</sup> / <sub>8</sub> "x29 <sup>1</sup> / <sub>2</sub> "	± 9 mm	Matte   Bush Hammered Line   Tumbled <b>Sensitech R10 B</b>

### LARGE SIZES P. 356

### OUTDOOR AND WET AREAS

37,5x75 cm - 14 <sup>3</sup> / <sub>8</sub> "x29 <sup>1</sup> / <sub>2</sub> "	± 9 mm	Grip <b>R11 C</b>
60x120 cm - 23 <sup>5</sup> / <sub>8</sub> "x47 <sup>1</sup> / <sub>4</sub> "	± 20 mm	Outdoor <b>R11 C</b>
60x60 cm - 23 <sup>5</sup> / <sub>8</sub> "x23 <sup>5</sup> / <sub>8</sub> "	± 20 mm	Outdoor <b>R11 C</b>



## Wall Tiles RECTIFIED MONOCALIBER

Sizes	Thickness	Surface finish
40x80 cm - 15 <sup>5</sup> / <sub>8</sub> "x31 <sup>1</sup> / <sub>2</sub> "	± 8,5 mm	Matte
<b>3D WALL TILES</b>		
40x80 cm - 15 <sup>5</sup> / <sub>8</sub> "x31 <sup>1</sup> / <sub>2</sub> "	± 10 mm	Matte



INDEX



A COMPLETE PRODUCT SYSTEM



PRODUCT FINDER



SURFACE RANGE



COMPANY



COLLECTIONS



3D WALL  
CONCRETE & RESIN LOOK  
METAL LOOK  
MARBLE LOOK  
STONE LOOK  
WOOD LOOK

LARGE SIZES



SLABS FOR COUNTERTOPS & FURNITURE



SINKS & BATHROOM FURNISHING



FACADES



TECHNICAL SPECIFICATIONS





# Lims

## Porcelain Tiles



Matte ± 6 mm  
Grip ± 9 mm  
Outdoor ± 20 mm



R9 A Matte ± 6 mm  
R10 B Matte / Line / Tumbled / Bush Hammered Sensitech (S) ± 9 mm  
R11 C Grip ± 9 mm  
R11 C Outdoor ± 20 mm

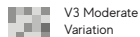

### MATTE SURFACE



± 6 mm  
120x278 cm - 47<sup>1</sup>/<sub>4</sub>"x109<sup>1</sup>/<sub>2</sub>"  
A3EI Lims Ivory  
A3EJ Lims Beige  
A3EK Lims Grey  
A3EL Lims Desert

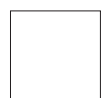

± 9 mm  
120x120 cm - 47<sup>1</sup>/<sub>4</sub>"x47<sup>1</sup>/<sub>4</sub>"  
A3DI Lims Ivory  
A3DJ Lims Beige  
A3DK Lims Grey  
A3DL Lims Desert



± 9 mm  
75x150 cm - 29<sup>1</sup>/<sub>2</sub>"x59"  
A7HT Lims Ivory  
A7HU Lims Beige  
A7HV Lims Grey  
A7HW Lims Desert



± 9 mm  
75x75 cm - 29<sup>1</sup>/<sub>2</sub>"x29<sup>1</sup>/<sub>2</sub>"  
A3DQ Lims Ivory  
A3DR Lims Beige  
A3DS Lims Grey  
A3DT Lims Desert



± 9 mm  
37,5x75 cm - 14<sup>3</sup>/<sub>4</sub>"x29<sup>1</sup>/<sub>2</sub>"  
A3DU Lims Ivory  
A3DV Lims Beige  
A3DW Lims Grey  
A3DX Lims Desert

### LINE SURFACE



± 9 mm  
37,5x75 cm - 14<sup>3</sup>/<sub>4</sub>"x29<sup>1</sup>/<sub>2</sub>"  
A3EE Lims Ivory Line  
A3EF Lims Beige Line  
A3EG Lims Grey Line  
A3EH Lims Desert Line

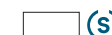

± 9 mm  
37,5x75 cm - 14<sup>3</sup>/<sub>4</sub>"x29<sup>1</sup>/<sub>2</sub>"  
A3EA Lims Ivory Bush Hammered  
A3EB Lims Beige Bush Hammered  
A3EC Lims Grey Bush Hammered  
A3ED Lims Desert Bush Hammered

### TUMBLLED EDGES <sup>(1)</sup>



± 9 mm  
37,5x75 cm - 14<sup>3</sup>/<sub>4</sub>"x29<sup>1</sup>/<sub>2</sub>"  
A3FT Lims Ivory Tumbled  
A3FU Lims Beige Tumbled  
A3FV Lims Grey Tumbled  
A3FW Lims Desert Tumbled



### GRIP SURFACE



± 9 mm  
37,5x75 cm - 14<sup>3</sup>/<sub>4</sub>"x29<sup>1</sup>/<sub>2</sub>"  
A3DY Lims Ivory Grip  
A3DZ Lims Beige Grip  
A3DØ Lims Grey Grip  
A3D1 Lims Desert Grip



± 20 mm  
60x120 cm - 23<sup>5</sup>/<sub>8</sub>"x47<sup>1</sup>/<sub>4</sub>"  
A3LU Lims Ivory 20 mm  
A3LV Lims Beige 20 mm  
A3LW Lims Grey 20 mm  
A3LX Lims Desert 20 mm



± 20 mm  
60x60 cm - 23<sup>5</sup>/<sub>8</sub>"x23<sup>5</sup>/<sub>8</sub>"  
A3LY Lims Ivory 20 mm  
A3LZ Lims Beige 20 mm  
A3LØ Lims Grey 20 mm  
A3L1 Lims Desert 20 mm

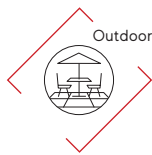

<sup>(1)</sup> Tumbled. Irregularities in the edges are not defects but rather features intrinsic to this type of product. - Burattato. Le irregolarità del bordo non sono da considerarsi un difetto ma una caratteristica intrinseca di questa tipologia di prodotto. - Tamisé. Les irrégularités des bords ne doivent pas être considérées comme un défaut mais comme une caractéristique intrinsèque de ce type de produit. - Genarbt. Die unregelmäßigen Kanten sind nicht als Fehler zu betrachten; sie sind ein für dieses Produkt charakteristisches Merkmal. - Tamboreado. Las irregularidades de los bordes no deben considerarse un defecto, sino una característica intrínseca de este tipo de productos. - Галтованная мозаика. Неровности граней являются не дефектом, а неотъемлемой характеристикой данного вида изделий.

### COMPLETE YOUR PROJECT



Furniture  
P.356



Sinks  
P.412



Facades  
P.436

MATTE



IVORY



BEIGE



GREY

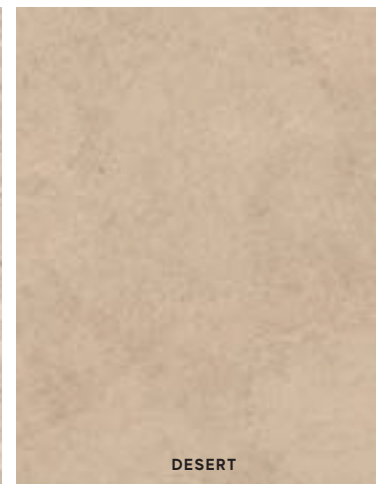

DESERT

LINE



IVORY



BEIGE



GREY



DESERT

BUSH HAMMERED



IVORY



BEIGE

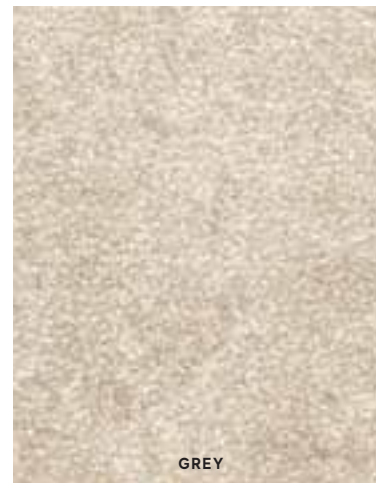

GREY



DESERT

TUMBLLED



IVORY



BEIGE



GREY



DESERT

INDEX



A COMPLETE  
PRODUCT  
SYSTEM



PRODUCT  
FINDER



SURFACE  
RANGE



COMPANY



COLLECTIONS



3D WALL  
CONCRETE & RESIN LOOK  
METAL LOOK  
MARBLE LOOK  
STONE LOOK  
WOOD LOOK

LARGE SIZES



SLABS FOR  
COUNTERTOPS  
& FURNITURE



SINKS &  
BATHROOM  
FURNISHING



FACADES



TECHNICAL  
SPECIFICATIONS



# Lims

## Porcelain Tiles

### DECOR RANGE



A3JE Lims Ivory  
Mosaico Gemini  
41,6x24 - 16<sup>1</sup>/<sub>8</sub>"x9<sup>1</sup>/<sub>2</sub>"



A3JF Lims Beige  
Mosaico Gemini  
41,6x24 - 16<sup>1</sup>/<sub>8</sub>"x9<sup>1</sup>/<sub>2</sub>"



A3JG Lims Grey  
Mosaico Gemini  
41,6x24 - 16<sup>1</sup>/<sub>8</sub>"x9<sup>1</sup>/<sub>2</sub>"



A3JH Lims Desert  
Mosaico Gemini  
41,6x24 - 16<sup>1</sup>/<sub>8</sub>"x9<sup>1</sup>/<sub>2</sub>"

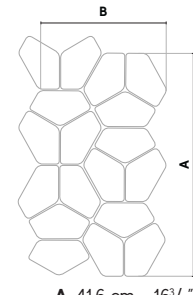

A 41,6 cm - 16<sup>1</sup>/<sub>8</sub>"  
B 24 cm - 9<sup>1</sup>/<sub>2</sub>"



A3NE Lims Ivory  
Mosaico Spritz <sup>(1)</sup>  
29x32,3 - 11<sup>1</sup>/<sub>8</sub>"x12<sup>1</sup>/<sub>4</sub>"



A3NF Lims Beige  
Mosaico Spritz <sup>(1)</sup>  
29x32,3 - 11<sup>1</sup>/<sub>8</sub>"x12<sup>1</sup>/<sub>4</sub>"



A3NG Lims Grey  
Mosaico Spritz <sup>(1)</sup>  
29x32,3 - 11<sup>1</sup>/<sub>8</sub>"x12<sup>1</sup>/<sub>4</sub>"



A3NH Lims Desert  
Mosaico Spritz <sup>(1)</sup>  
29x32,3 - 11<sup>1</sup>/<sub>8</sub>"x12<sup>1</sup>/<sub>4</sub>"

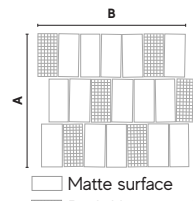

□ Matte surface  
■ Bush Hammered  
A 29 cm - 11<sup>1</sup>/<sub>8</sub>"  
B 32,3 cm - 12<sup>1</sup>/<sub>4</sub>"



A3HK Lims Ivory  
Mosaico Tumbled <sup>(1)</sup>  
30x30 - 11<sup>1</sup>/<sub>8</sub>"x11<sup>1</sup>/<sub>8</sub>"



A3HL Lims Beige  
Mosaico Tumbled <sup>(1)</sup>  
30x30 - 11<sup>1</sup>/<sub>8</sub>"x11<sup>1</sup>/<sub>8</sub>"



A3HM Lims Grey  
Mosaico Tumbled <sup>(1)</sup>  
30x30 - 11<sup>1</sup>/<sub>8</sub>"x11<sup>1</sup>/<sub>8</sub>"



A3HN Lims Desert  
Mosaico Tumbled <sup>(1)</sup>  
30x30 - 11<sup>1</sup>/<sub>8</sub>"x11<sup>1</sup>/<sub>8</sub>"

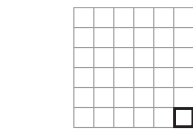

4,8x4,8 cm - 1<sup>1</sup>/<sub>8</sub>"x1<sup>1</sup>/<sub>8</sub>"



A3JA Lims Ivory Brick  
37,5x75 - 14<sup>3</sup>/<sub>4</sub>"x29<sup>1</sup>/<sub>2</sub>"



A3JB Lims Beige Brick  
37,5x75 - 14<sup>3</sup>/<sub>4</sub>"x29<sup>1</sup>/<sub>2</sub>"

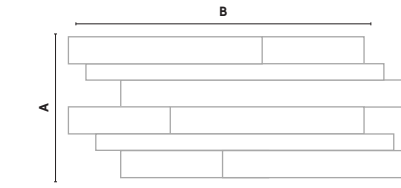

A 37,5 cm - 14<sup>3</sup>/<sub>4</sub>"  
B 75 cm - 29<sup>1</sup>/<sub>2</sub>"



A3JC Lims Grey Brick  
37,5x75 - 14<sup>3</sup>/<sub>4</sub>"x29<sup>1</sup>/<sub>2</sub>"



A3JD Lims Desert Brick  
37,5x75 - 14<sup>3</sup>/<sub>4</sub>"x29<sup>1</sup>/<sub>2</sub>"

TRIM TILES p. 352	Battiscopa	Gradino *	Scalino *	Scalino Ang.*	Battiscopa Sag. Scala *	Elemento L *	Corner *	Corner A.E *				
	7,2x75 cm 2 <sup>1</sup> / <sub>8</sub> "x29 <sup>1</sup> / <sub>2</sub> " Matte	37,5x75 cm 14 <sup>3</sup> / <sub>4</sub> "x29 <sup>1</sup> / <sub>2</sub> " Matte	37,5x150 cm 14 <sup>3</sup> / <sub>4</sub> "x59" Matte	33x120 cm 13"x47 <sup>1</sup> / <sub>2</sub> " Matte	37,5x75 cm 14 <sup>3</sup> / <sub>4</sub> "x29 <sup>1</sup> / <sub>2</sub> " Matte	37,5x37,5 cm 14 <sup>3</sup> / <sub>4</sub> "x14 <sup>3</sup> / <sub>4</sub> " Matte	33x33 cm 13"x13" Matte	7,2x30 cm 2 <sup>1</sup> / <sub>8</sub> "x11 <sup>1</sup> / <sub>8</sub> " Matte	15x75 H. 4 cm 5 <sup>1</sup> / <sub>8</sub> "x29 <sup>1</sup> / <sub>2</sub> " H. 1 <sup>1</sup> / <sub>8</sub> " Grip	1x120 cm 3 <sup>1</sup> / <sub>8</sub> "x47 <sup>1</sup> / <sub>2</sub> " Matte	1x1 cm 3 <sup>1</sup> / <sub>8</sub> "x7 <sup>1</sup> / <sub>8</sub> " Matte	
Ivory	A3MK	A3VV	A3NU	A3NQ	A3VZ	A3WD	A3NY	DX A3JQ	SX A3JM	A3N2	A3WH	A3WL
Beige	A3ML	A3VW	A3NV	A3NR	A3WA	A3WE	A3NZ	A3JR	A3JN	A3N3	A3WI	A3WM
Grey	A3VT	A3VX	A3NW	A3NS	A3WB	A3WF	A3NØ	A3JS	A3JO	A3N4	A3WJ	A3WN
Desert	A3VU	A3VY	A3NX	A3NT	A3WC	A3WG	A3N1	A3JT	A3JP	A3N5	A3WK	A3WO

\* These parts are supplied to order - I pezzi sono disponibili su ordinazione - Les pièces sont disponibles sur commande - Die Teile sind auf Bestellung lieferbar - Las piezas se hacen por encargo - Изготавливаются на заказ

<sup>(1)</sup> Tumbled. Irregularities in the edges are not defects but rather features intrinsic to this type of product. - Burattato. Le irregolarità del bordo non sono da considerarsi un difetto ma una caratteristica intrinseca di questa tipologia di prodotto. - Tamisé. Les irrégularités des bords ne doivent pas être considérées comme un défaut mais comme une caractéristique intrinsèque de ce type de produit. - Genarbt. Die unregelmäßigen Kanten sind nicht als Fehler zu betrachten; sie sind ein für dieses Produkt charakteristisches Merkmal. - Tamboreado. Las irregularidades de los bordes no deben considerarse un defecto, sino una característica intrínseca de este tipo de productos. - Галтованная мозаика. Неровности граней являются не дефектом, а неотъемлемой характеристикой данного вида изделий.

INDEX



A COMPLETE  
PRODUCT  
SYSTEM



PRODUCT  
FINDER



SURFACE  
RANGE



COMPANY



COLLECTIONS



3D WALL  
CONCRETE & RESIN LOOK  
METAL LOOK  
MARBLE LOOK  
STONE LOOK  
WOOD LOOK

LARGE SIZES



SLABS FOR  
COUNTERTOPS  
& FURNITURE



SINKS &  
BATHROOM  
FURNISHING



FACADES



TECHNICAL  
SPECIFICATIONS





# Lims

## Wall Tiles

### MATTE SURFACE

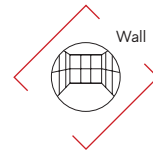
 **± 8,5 mm**  
**40x80 cm - 15<sup>7</sup>/<sub>8</sub>"x31<sup>1</sup>/<sub>2</sub>"**  
 A3HO Lims Ivory  
 A3HP Lims Beige



 **± 10 mm 3D WALL**  
**40x80 cm - 15<sup>7</sup>/<sub>8</sub>"x31<sup>1</sup>/<sub>2</sub>"**  
 A3HR Lims 3D Wallpaper Ivory  
 A3HS Lims 3D Wallpaper Beige  
 A3HT Lims 3D Way Ivory  
 A3HU Lims 3D Way Beige

### TRIM TILES

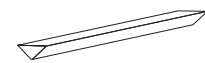

**1,4x40 cm - 5<sup>5</sup>/<sub>8</sub>"x15<sup>7</sup>/<sub>8</sub>"**  
 A3HV Lims Ivory Corner 40 \*  
 A3HW Lims Beige Corner 40 \*



**1,4x1,4 cm - 5<sup>5</sup>/<sub>8</sub>"x5<sup>5</sup>/<sub>8</sub>"**  
 A3HZ Lims Ivory Corner A.E. \*  
 A3HØ Lims Beige Corner A.E. \*

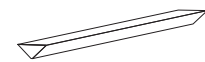

**1,4x40 cm - 5<sup>5</sup>/<sub>8</sub>"x15<sup>7</sup>/<sub>8</sub>"**  
 A3HX Lims 3D Wallpaper Ivory Corner 40 \*  
 A3HY Lims 3D Wallpaper Beige Corner 40 \*

\* These parts are supplied to order - I pezzi sono disponibili su ordinazione - Les pièces sont disponibles sur commande - Die Teile sind auf Bestellung lieferbar - Las piezas se hacen por encargo - Изготавливаются на заказ



IVORY



BEIGE

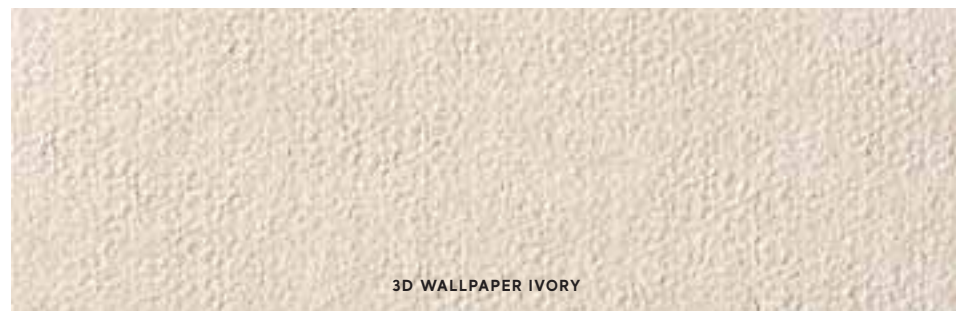

3D WALLPAPER IVORY



3D WALLPAPER BEIGE

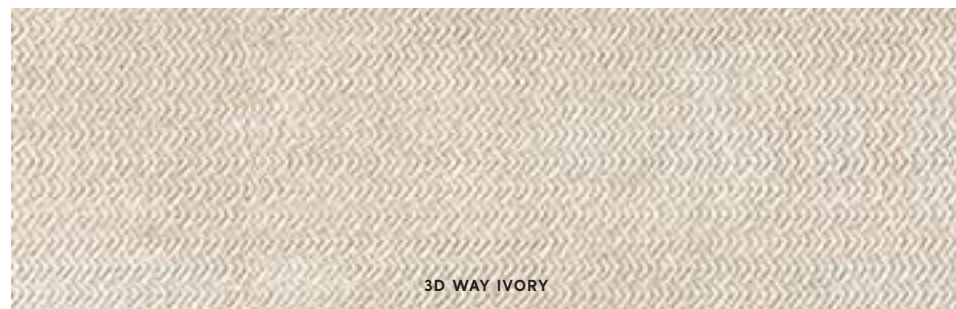

3D WAY IVORY



3D WAY BEIGE



© Ceramiche Atlas Concorde



© Ceramiche Atlas Concorde

INDEX



A COMPLETE PRODUCT SYSTEM >

PRODUCT FINDER >

SURFACE RANGE >

COMPANY >

COLLECTIONS >

3D WALL  
 CONCRETE & RESIN LOOK  
 METAL LOOK  
 MARBLE LOOK  
 STONE LOOK  
 WOOD LOOK

LARGE SIZES >

SLABS FOR COUNTERTOPS & FURNITURE >

SINKS & BATHROOM FURNISHING >

FACADES >

TECHNICAL SPECIFICATIONS >

# Marvel Stone

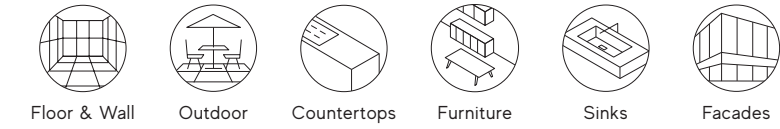

© Ceramiche Atlas Concorde



## Porcelain Tiles RECTIFIED MONOCALIBER

Sizes	Thickness	Surface finish
120x240 cm - 47 1/4" x 94 1/2"	± 9 mm	Matte <b>R9 A</b>
120x120 cm - 47 1/4" x 47 1/4"	± 9 mm	Matte <b>Sensitech R10 B</b>
75x150 cm - 29 1/2" x 59"	± 9 mm	Matte <b>Sensitech R10 B</b>
75x75 cm - 29 1/2" x 29 1/2"	± 9 mm	Matte <b>Sensitech R10 B</b>
60x60 cm - 23 5/8" x 23 5/8"	± 9 mm	Matte <b>Sensitech R10 B</b>

LARGE SIZES P. 356

MARVEL STONE COLLECTION MARBLE LOOK p. 218

atlasPLAN

### SLABS FOR COUNTERTOPS & FURNITURE

162x324 cm - 63 3/4" x 127 1/2"	± 6-12-20 mm	Hammered
---------------------------------	--------------	----------



© Ceramiche Atlas Concorde



© Ceramiche Atlas Concorde

INDEX



A COMPLETE PRODUCT SYSTEM



PRODUCT FINDER



SURFACE RANGE



COMPANY



COLLECTIONS



3D WALL  
CONCRETE & RESIN LOOK  
METAL LOOK  
MARBLE LOOK  
STONE LOOK  
WOOD LOOK

LARGE SIZES



SLABS FOR COUNTERTOPS & FURNITURE



SINKS & BATHROOM FURNISHING



FACADES



TECHNICAL SPECIFICATIONS



# Marvel Stone

## Porcelain Tiles



Matte ± 9 mm  
Matte Sensitech (S) ± 9 mm



R9 A Matte ± 9 mm  
R10 B Matte Sensitech (S) ± 9 mm



V2 Slight  
Variation



### MATTE SURFACE



± 9 mm  
**120x240 cm** - 47<sup>1</sup>/<sub>4</sub>"x94<sup>1</sup>/<sub>2</sub>"  
AZT2 Marvel Clauzetto White  
AZT1 Marvel Cardoso Elegant  
AZTØ Marvel Basaltina Volcano



± 9 mm  
**120x120 cm** - 47<sup>1</sup>/<sub>4</sub>"x47<sup>1</sup>/<sub>4</sub>"  
AZT5 Marvel Clauzetto White  
AZT4 Marvel Cardoso Elegant  
AZT3 Marvel Basaltina Volcano



± 9 mm  
**75x150 cm** - 29<sup>1</sup>/<sub>2</sub>"x59"  
A7H9 Marvel Clauzetto White  
A7H8 Marvel Desert Beige  
A7H7 Marvel Cardoso Elegant  
A7H6 Marvel Basaltina Volcano

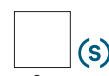

± 9 mm  
**75x75 cm** - 29<sup>1</sup>/<sub>2</sub>"x29<sup>1</sup>/<sub>2</sub>"  
AZNV Marvel Clauzetto White  
AZNU Marvel Desert Beige  
AZNT Marvel Cardoso Elegant  
AZNS Marvel Basaltina Volcano



± 9 mm  
**60x60 cm** - 23<sup>5</sup>/<sub>8</sub>"x23<sup>5</sup>/<sub>8</sub>"  
AZQ9 Marvel Clauzetto White  
AZQ8 Marvel Desert Beige  
AZQ7 Marvel Cardoso Elegant  
AZQ6 Marvel Basaltina Volcano



CLAUZETTO WHITE



DESERT BEIGE

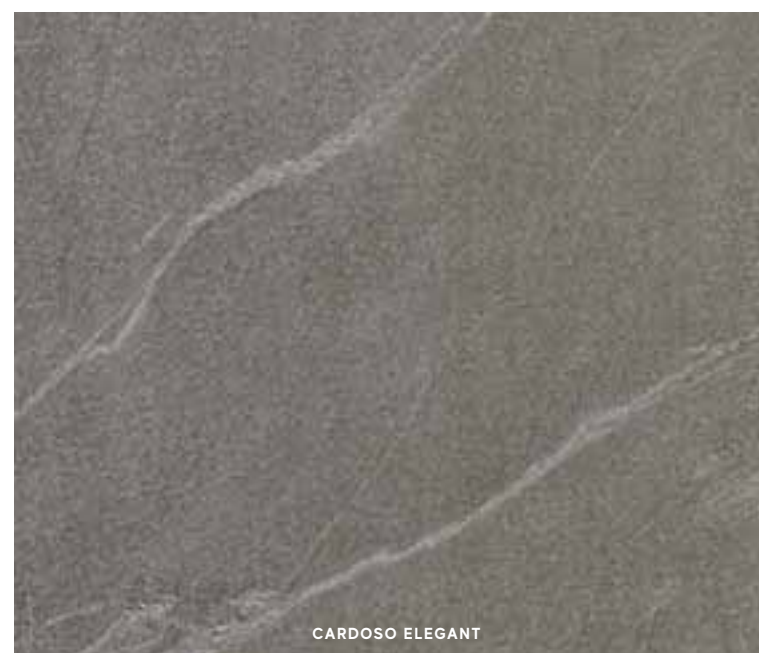

CARDOSO ELEGANT



BASALTINA VOLCANO

### TRIM TILES p. 352

#### Battiscopa

7,2x60 cm  
2<sup>1</sup>/<sub>8</sub>"x23<sup>1</sup>/<sub>8</sub>"  
Matte

Clauzetto White ATFG  
Desert Beige ATFF  
Cardoso Elegant ATFE  
Basaltina Volcano ATFD

#### Scalino \*

Digitale 4,6x60 cm  
1<sup>1</sup>/<sub>4</sub>"x23<sup>1</sup>/<sub>8</sub>"  
Matte

ATFC  
ATFB  
ATFA  
ATE9

#### Scalino Ang.\*

33x33 cm  
13"x13"  
Matte

DX ATG2  
ATG1  
ATGØ  
ATGZ  
SX ATGY  
ATGX  
ATGW  
ATGV

#### Battiscopa Sag. Scala \*

7,2x30 cm  
2<sup>1</sup>/<sub>8</sub>"x11<sup>1</sup>/<sub>4</sub>"  
Matte

DX ATHR  
ATHQ  
ATHP  
ATHO  
SX ATHV  
ATHU  
ATHT  
ATHS

\* These parts are supplied to order - I pezzi sono disponibili su ordinazione - Les pièces sont disponibles sur commande - Die Teile sind auf Bestellung lieferbar - Las piezas se hacen por encargo - Изготавливаются на заказ

### COMPLETE YOUR PROJECT

- Countertops P.402  
162x324 cm  
NON-RECTIFIED
- Furniture P.356
- Sinks P.412
- Facades P.436

INDEX



A COMPLETE  
PRODUCT  
SYSTEM



PRODUCT  
FINDER



SURFACE  
RANGE



COMPANY



COLLECTIONS



3D WALL  
CONCRETE & RESIN LOOK  
METAL LOOK  
MARBLE LOOK  
STONE LOOK  
WOOD LOOK

LARGE SIZES



SLABS FOR  
COUNTERTOPS  
& FURNITURE



SINKS &  
BATHROOM  
FURNISHING



FACADES



TECHNICAL  
SPECIFICATIONS



# Marvel Stone

## Porcelain Tiles

### DECOR RANGE



AS4J Marvel Clauzetto White Mosaico Bacchetta 30x30 - 1<sup>1</sup>/<sub>4</sub>"x1<sup>1</sup>/<sub>4</sub>"  
 AS4I Marvel Desert Beige Mosaico Bacchetta 30x30 - 1<sup>1</sup>/<sub>4</sub>"x1<sup>1</sup>/<sub>4</sub>"  
 AS4H Marvel Cardoso Elegant Mosaico Bacchetta 30x30 - 1<sup>1</sup>/<sub>4</sub>"x1<sup>1</sup>/<sub>4</sub>"  
 AS4G Marvel Basaltina Volcano Mosaico Bacchetta 30x30 - 1<sup>1</sup>/<sub>4</sub>"x1<sup>1</sup>/<sub>4</sub>"



AS4N Marvel Clauzetto White Mosaico Burattato <sup>(1)</sup> 29,8x29,8 - 1<sup>1</sup>/<sub>8</sub>"x1<sup>1</sup>/<sub>8</sub>"  
 AS4M Marvel Desert Beige Mosaico Burattato <sup>(1)</sup> 29,8x29,8 - 1<sup>1</sup>/<sub>8</sub>"x1<sup>1</sup>/<sub>8</sub>"  
 AS4L Marvel Cardoso Elegant Mosaico Burattato <sup>(1)</sup> 29,8x29,8 - 1<sup>1</sup>/<sub>8</sub>"x1<sup>1</sup>/<sub>8</sub>"  
 AS4K Marvel Basaltina Volcano Mosaico Burattato <sup>(1)</sup> 29,8x29,8 - 1<sup>1</sup>/<sub>8</sub>"x1<sup>1</sup>/<sub>8</sub>"



AS4F Marvel Clauzetto White Mosaico 30x30 - 1<sup>1</sup>/<sub>4</sub>"x1<sup>1</sup>/<sub>4</sub>"  
 AS4E Marvel Desert Beige Mosaico 30x30 - 1<sup>1</sup>/<sub>4</sub>"x1<sup>1</sup>/<sub>4</sub>"  
 AS4D Marvel Cardoso Elegant Mosaico 30x30 - 1<sup>1</sup>/<sub>4</sub>"x1<sup>1</sup>/<sub>4</sub>"  
 AS4C Marvel Basaltina Volcano Mosaico 30x30 - 1<sup>1</sup>/<sub>4</sub>"x1<sup>1</sup>/<sub>4</sub>"

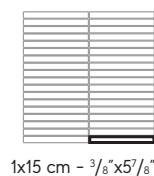

1x15 cm - 3/8"x5 7/8"

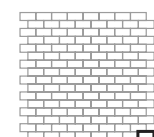

3,5x1,7 cm - 1 1/8"x2 3/8"



3,5x3,5 cm - 1 1/8"x1 1/8"



AS4S Marvel Clauzetto White Brick 30x60 - 11 1/4"x23 3/8"  
 AS4Q Marvel Desert Beige Brick 30x60 - 11 1/4"x23 3/8"

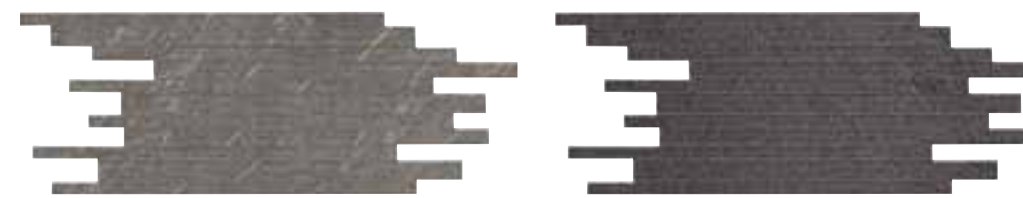

AS4P Marvel Cardoso Elegant Brick 30x60 - 11 1/4"x23 3/8"  
 AS4O Marvel Basaltina Volcano Brick 30x60 - 11 1/4"x23 3/8"



AS5A Marvel Clauzetto White Brick 3D <sup>(2)</sup> 30x59 - 11 1/4"x23 1/4"  
 AS49 Marvel Desert Beige Brick 3D <sup>(2)</sup> 30x59 - 11 1/4"x23 1/4"



AS48 Marvel Cardoso Elegant Brick 3D <sup>(2)</sup> 30x59 - 11 1/4"x23 1/4"  
 AS47 Marvel Basaltina Volcano Brick 3D <sup>(2)</sup> 30x59 - 11 1/4"x23 1/4"

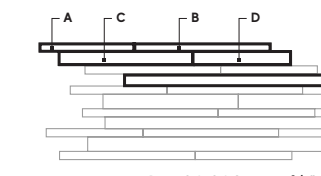

A 2,1x24,8 cm - 3/4"x9 3/4"  
 B 2,1x34,5 cm - 3/4"x13 3/8"  
 C 3,3x34,5 cm - 1 1/8"x13 3/8"  
 D 3,3x24,8 cm - 1 1/8"x9 3/4"  
 E 2,5x60 cm - 1"x23 3/8"

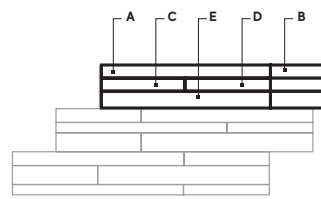

A 3,1x39,5 cm - 1 1/4"x15 1/2"  
 B 3,1x19,5 cm - 1 1/4"x7 7/8"  
 C 2,3x19,5 cm - 7/8"x7 7/8"  
 D 2,3x39,5 cm - 7/8"x15 1/2"  
 E 4,5x39,5 cm - 1 3/4"x15 1/2"  
 F 4,5x19,5 cm - 1 3/4"x7 7/8"

<sup>(1)</sup> Tumbled. Irregularities in the edges are not defects but rather features intrinsic to this type of product. - Burattato. Le irregolarità del bordo non sono da considerarsi un difetto ma una caratteristica intrinseca di questa tipologia di prodotto. - Tamisé. Les irrégularités des bords ne doivent pas être considérées comme un défaut mais comme une caractéristique intrinsèque de ce type de produit. - Genarbt. Die unregelmäßigen Kanten sind nicht als Fehler zu betrachten; sie sind ein für dieses Produkt charakteristisches Merkmal. - Tamboreado. Las irregularidades de los bordes no deben considerarse un defecto, sino una característica intrínseca de este tipo de productos. - Гальтованная мозаика. Неровности граней являются не дефектом, а неотъемлемой характеристикой данного вида изделий.

<sup>(2)</sup> Multi-thickness mosaic, close joint installation without grouting. - Mosaico multispessore, posa senza stuccatura a giunto unito. - Mosaïque multi-épaisseur, pose sans mastic avec joint nul. - Mosaik mit verschiedenen Stärken, fugenlose Verlegung ohne Mörtel. - Mosaico multiespesor, colocación sin mástico y sin juntas. - Мозаика разной толщины; укладка встык без затирки швов.

The decoration can only be laid on the wall - Il decoro si può posare solo a rivestimento - Décor uniquement mural - Das Dekor kann nur an der Wand verlegt werden - La decoración se puede colocar únicamente en paredes - Декор может быть уложен только на стену.

INDEX



A COMPLETE PRODUCT SYSTEM



PRODUCT FINDER



SURFACE RANGE



COMPANY



COLLECTIONS



3D WALL  
 CONCRETE & RESIN LOOK  
 METAL LOOK  
 MARBLE LOOK  
 STONE LOOK  
 WOOD LOOK

LARGE SIZES



SLABS FOR COUNTERTOPS & FURNITURE



SINKS & BATHROOM FURNISHING



FACADES



TECHNICAL SPECIFICATIONS



# Norde



© Ceramiche Atlas Concorde



© Ceramiche Atlas Concorde



© Ceramiche Atlas Concorde

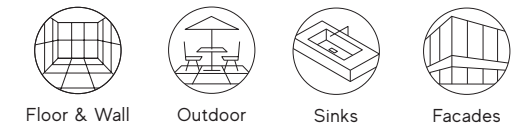

## Porcelain Tiles RECTIFIED MONOCALIBER

Sizes	Thickness	Surface finish
60x120 cm - 23 <sup>5</sup> / <sub>8</sub> "x47 <sup>1</sup> / <sub>4</sub> "	± 9 mm	Matte Sensitech R10 B
60x60 cm - 23 <sup>5</sup> / <sub>8</sub> "x23 <sup>5</sup> / <sub>8</sub> "	± 9 mm	Matte Sensitech R10 B
30x60 cm - 11 <sup>1</sup> / <sub>4</sub> "x23 <sup>5</sup> / <sub>8</sub> "	± 9 mm	Matte Sensitech R10 B

### OUTDOOR AND WET AREAS

30x60 cm - 11 <sup>1</sup> / <sub>4</sub> "x23 <sup>5</sup> / <sub>8</sub> "	± 9 mm	Roccia R12 C
60x120 cm - 23 <sup>5</sup> / <sub>8</sub> "x47 <sup>1</sup> / <sub>4</sub> "	± 9 mm	Grip R11 C
60x120 cm - 23 <sup>5</sup> / <sub>8</sub> "x47 <sup>1</sup> / <sub>4</sub> "	± 20 mm	Outdoor R11 C
60x90 cm - 23 <sup>5</sup> / <sub>8</sub> "x35 <sup>3</sup> / <sub>8</sub> "	± 20 mm	Outdoor R11 C
60x60 cm - 23 <sup>5</sup> / <sub>8</sub> "x23 <sup>5</sup> / <sub>8</sub> "	± 20 mm	Outdoor R11 C
80x80 cm - 31 <sup>1</sup> / <sub>2</sub> "x31 <sup>1</sup> / <sub>2</sub> "	± 20 mm	Outdoor R11 C

INDEX



A COMPLETE PRODUCT SYSTEM



PRODUCT FINDER



SURFACE RANGE



COMPANY



COLLECTIONS



3D WALL  
CONCRETE & RESIN LOOK  
METAL LOOK  
MARBLE LOOK  
STONE LOOK  
WOOD LOOK

LARGE SIZES



SLABS FOR COUNTERTOPS & FURNITURE



SINKS & BATHROOM FURNISHING



FACADES



TECHNICAL SPECIFICATIONS



# Norde

## Porcelain Tiles

### MATTE SURFACE



**± 9 mm**  
**60x120 cm** - 23<sup>5</sup>/<sub>8</sub>"x47<sup>1</sup>/<sub>4</sub>"  
 A5LM Norde Magnesio  
 A5LN Norde Oro  
 A45Z Norde Platino  
 A5LO Norde Piombo

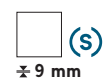

**± 9 mm**  
**60x60 cm** - 23<sup>5</sup>/<sub>8</sub>"x23<sup>5</sup>/<sub>8</sub>"  
 A5M6 Norde Magnesio  
 A5M7 Norde Oro  
 A5M8 Norde Platino  
 A5M9 Norde Piombo



**± 9 mm**  
**30x60 cm** - 11<sup>3</sup>/<sub>4</sub>"x23<sup>5</sup>/<sub>8</sub>"  
 A5ND Norde Magnesio  
 A5NE Norde Oro  
 A5NF Norde Platino  
 A5NG Norde Piombo

### GRIP SURFACE



**± 9 mm**  
**60x120 cm** - 23<sup>5</sup>/<sub>8</sub>"x47<sup>1</sup>/<sub>4</sub>"  
 A5MH Norde Magnesio Grip  
 A5MI Norde Oro Grip  
 A45Ø Norde Platino Grip  
 A5MJ Norde Piombo Grip

### ROCCIA SURFACE



**± 9 mm**  
**30x60 cm** - 11<sup>3</sup>/<sub>4</sub>"x23<sup>5</sup>/<sub>8</sub>"  
 A5NA Norde Magnesio Roccia  
 A5NB Norde Oro Roccia  
 A5NC Norde Platino Roccia  
 A45Y Norde Piombo Roccia

### OUTDOOR ± 20 mm

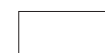

**± 20 mm**  
**60x120 cm** - 23<sup>5</sup>/<sub>8</sub>"x47<sup>1</sup>/<sub>4</sub>"  
 A5TV Norde Magnesio 20 mm  
 A5TW Norde Oro 20 mm  
 A45I Norde Platino 20 mm  
 A5TX Norde Piombo 20 mm

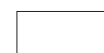

**± 20 mm**  
**60x90 cm** - 23<sup>5</sup>/<sub>8</sub>"x35<sup>3</sup>/<sub>8</sub>"  
 A5T2 Norde Magnesio 20 mm  
 A5T3 Norde Oro 20 mm  
 A5T4 Norde Platino 20 mm  
 A5T5 Norde Piombo 20 mm



**± 20 mm**  
**60x60 cm** - 23<sup>5</sup>/<sub>8</sub>"x23<sup>5</sup>/<sub>8</sub>"  
 A5TY Norde Magnesio 20 mm  
 A5TZ Norde Oro 20 mm  
 A5TØ Norde Platino 20 mm  
 A5T1 Norde Piombo 20 mm



**± 20 mm**  
**80x80 cm** - 31<sup>1</sup>/<sub>2</sub>"x31<sup>1</sup>/<sub>2</sub>"  
 A56L Norde Magnesio 20 mm  
 A56M Norde Oro 20 mm  
 A56N Norde Platino 20 mm  
 A56O Norde Piombo 20 mm

**H** Matte Sensitech (S) ± 9 mm  
 Grip / Roccia ± 9 mm  
 Outdoor ± 20 mm  
**HEAVY TRAFFIC**

**R10 B** Matte Sensitech (S) ± 9 mm  
**R11 C** Grip ± 9 mm  
**R12 C** Roccia ± 9 mm  
**R11 C** Outdoor ± 20 mm

V3 Moderate  
 Variation

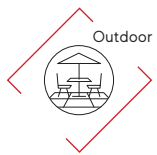

MATTE / GRIP



MAGNESIO



ORO



PLATINO



PIOMBO

ROCCIA



MAGNESIO



ORO



PLATINO



PIOMBO

OUTDOOR 20 mm



MAGNESIO



ORO



PLATINO



PIOMBO

### TRIM TILES

p. 352

#### Battiscopa

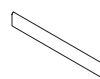

72x60 cm  
 2<sup>7</sup>/<sub>8</sub>"x23<sup>5</sup>/<sub>8</sub>"  
 Matte

#### Gradino \*



30x60 cm  
 11<sup>3</sup>/<sub>4</sub>"x23<sup>5</sup>/<sub>8</sub>"  
 Matte

#### Scalino \*



33x120 cm  
 13"x47<sup>1</sup>/<sub>4</sub>"  
 Matte

33x60 cm  
 13"x23<sup>5</sup>/<sub>8</sub>"  
 Matte

#### Scalino Ang. \*

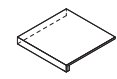

33x33 cm  
 13"x13"  
 Matte

#### Battiscopa Sag. Scala \*



72x30 cm  
 2<sup>7</sup>/<sub>8</sub>"x11<sup>3</sup>/<sub>4</sub>"  
 Matte

#### Elemento L \*



33x120 H. 4 cm  
 13"x47<sup>1</sup>/<sub>4</sub>" H.1<sup>1</sup>/<sub>2</sub>"  
 Grip

15x60 H. 4 cm  
 5<sup>7</sup>/<sub>8</sub>"x23<sup>5</sup>/<sub>8</sub>" H.1<sup>1</sup>/<sub>2</sub>"  
 Roccia

Magnesio  
 Oro  
 Platino  
 Piombo

A58Y  
 A58Z  
 A58I  
 A582

A59D  
 A59E  
 A59F  
 A59G

A59T  
 A59U  
 A59V  
 A59W

A59H  
 A59I  
 A59J  
 A59K

A59X  
 A59Y  
 A59Z  
 A59I

DX  
 A583  
 A584  
 A585  
 A586

SX  
 A587  
 A588  
 A589  
 A59C

A592  
 A593  
 A594  
 A595

A6H2  
 A6H3  
 A6H4  
 A6H5

\* These parts are supplied to order - I pezzi sono disponibili su ordinazione - Les pièces sont disponibles sur commande - Die Teile sind auf Bestellung lieferbar - Las piezas se hacen por encargo - Изготавливаются на заказ

### COMPLETE YOUR PROJECT



A COMPLETE  
 PRODUCT  
 SYSTEM >

PRODUCT  
 FINDER >

SURFACE  
 RANGE >

COMPANY >

COLLECTIONS >

3D WALL  
 CONCRETE & RESIN LOOK  
 METAL LOOK  
 MARBLE LOOK  
 STONE LOOK  
 WOOD LOOK

LARGE SIZES >

SLABS FOR  
 COUNTERTOPS  
 & FURNITURE >

SINKS &  
 BATHROOM  
 FURNISHING >

FACADES >

TECHNICAL  
 SPECIFICATIONS >



# Norde

## Porcelain Tiles

### DECOR RANGE



A59P Norde Magnesio Brick  
30x60 - 11<sup>1</sup>/<sub>4</sub>"x23<sup>3</sup>/<sub>8</sub>"



A59Q Norde Oro Brick  
30x60 - 11<sup>1</sup>/<sub>4</sub>"x23<sup>3</sup>/<sub>8</sub>"

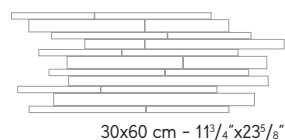

A59R Norde Platino Brick  
30x60 - 11<sup>1</sup>/<sub>4</sub>"x23<sup>3</sup>/<sub>8</sub>"



A59S Norde Piombo Brick  
30x60 - 11<sup>1</sup>/<sub>4</sub>"x23<sup>3</sup>/<sub>8</sub>"



A596 Norde Magnesio Brick Corten  
39x27,8 - 15<sup>3</sup>/<sub>8</sub>"x11" <sup>(1)</sup>



A597 Norde Oro Brick Corten  
39x27,8 - 15<sup>3</sup>/<sub>8</sub>"x11" <sup>(1)</sup>



A598 Norde Platino Brick Corten  
39x27,8 - 15<sup>3</sup>/<sub>8</sub>"x11" <sup>(1)</sup>



A599 Norde Piombo Brick Corten  
39x27,8 - 15<sup>3</sup>/<sub>8</sub>"x11" <sup>(1)</sup>

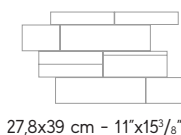

A59L Norde Magnesio Mosaico  
30x30 - 11<sup>1</sup>/<sub>4</sub>"x11<sup>1</sup>/<sub>4</sub>"



A59M Norde Oro Mosaico  
30x30 - 11<sup>1</sup>/<sub>4</sub>"x11<sup>1</sup>/<sub>4</sub>"



A59N Norde Platino Mosaico  
30x30 - 11<sup>1</sup>/<sub>4</sub>"x11<sup>1</sup>/<sub>4</sub>"



A59O Norde Piombo Mosaico  
30x30 - 11<sup>1</sup>/<sub>4</sub>"x11<sup>1</sup>/<sub>4</sub>"

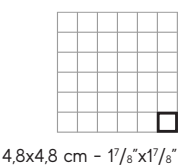

A58U Norde Magnesio Composizione Palladiana Grip <sup>(2) (3)</sup>



A58V Norde Oro Composizione Palladiana Grip <sup>(2) (3)</sup>



A58W Norde Platino Composizione Palladiana Grip <sup>(2) (3)</sup>



A58X Norde Piombo Composizione Palladiana Grip <sup>(2) (3)</sup>

<sup>(1)</sup> **Blaze Corten tessera inserted randomly in four of the six sheets contained in each box.** - Tessera Blaze Corten inserita in modo casuale in quattro dei sei fogli contenuti in ogni scatola. - Tesselles Blaze Corten posées de manière aléatoire sur quatre des six feuilles contenues dans chaque boîte. - Die Blaze Corten Steine werden nach dem Zufallsprinzip auf vier der sechs in jedem Karton enthaltenen Folien verklebt. - Mosaico Blaze Corten insertado al azar en cuatro de las seis hojas que contiene cada caja. - Чип Blaze Corten вложен случайным образом в четыре из шести матриц, содержащихся в каждой коробке.

<sup>(2)</sup> **Minimum order: 8 m<sup>2</sup>. Variable tessera size and shape with tumbled edge. We recommend installation with a joint of no less than 10 mm.** - Ordine minimo di 8 mq. Dimensione e forma delle tessere variabile con bordo burattato. Si consiglia posa con fuga non inferiore a 10mm. - Commande minimum: 8 mètres carrés. Dimensions et forme des tesselles variables avec bord tamisé. Pose conseillée avec un joint non inférieur à 10mm. - Mindestbestellmenge 8 qm. Abmessung und Form der Steine sind unterschiedlich, aber alle weisen getrommelte Kanten auf. Für die Verlegung wird eine Fugenbreite von nicht weniger als 10 mm empfohlen. - Pedido mínimo de 8 m<sup>2</sup>. Tamaño y forma variable de los mosaicos con borde bruñido. Se recomienda colocación con junta de no menos de 10 mm. - Минимальный объем заказа - 8 кв.м. Размер и форма чипа варьируются, чипы имеют выщербленные края. Рекомендуется укладка с межплиточным швом не менее 10 мм.

<sup>(3)</sup> **Example of layout measuring about 1 m<sup>2</sup>.** - Esempio di posato corrispondente a circa 1 mq. - Exemple de produit posé correspondant à 1 mètre carré environ. - Verlegebeispiel für circa 1 qm. - Ejemplo de colocación correspondiente aproximadamente a 1 m<sup>2</sup>. - Пример укладки, соответствующий примерно 1 кв.м.

INDEX



A COMPLETE PRODUCT SYSTEM



PRODUCT FINDER



SURFACE RANGE



COMPANY



COLLECTIONS



3D WALL  
CONCRETE & RESIN LOOK  
METAL LOOK  
MARBLE LOOK  
STONE LOOK  
WOOD LOOK

LARGE SIZES



SLABS FOR COUNTERTOPS & FURNITURE



SINKS & BATHROOM FURNISHING



FACADES



TECHNICAL SPECIFICATIONS



# Norde

## Porcelain Tiles

### DECOR RANGE



A58M Norde Magnesio Path A+B 20 mm <sup>(1)</sup>  
54x54 - 21<sup>1</sup>/<sub>4</sub>"x21<sup>1</sup>/<sub>4</sub>"

A58Q Norde Magnesio Path C 20 mm <sup>(1)</sup>  
55x109 - 21<sup>1</sup>/<sub>8</sub>"x42<sup>7</sup>/<sub>8</sub>"

A58N Norde Oro Path A+B 20mm <sup>(1)</sup>  
54x54 - 21<sup>1</sup>/<sub>4</sub>"x21<sup>1</sup>/<sub>4</sub>"

A58R Norde Oro Path C 20mm <sup>(1)</sup>  
55x109 - 21<sup>1</sup>/<sub>8</sub>"x42<sup>7</sup>/<sub>8</sub>"



A58O Norde Platino Path A+B 20 mm <sup>(1)</sup>  
54x54 - 21<sup>1</sup>/<sub>4</sub>"x21<sup>1</sup>/<sub>4</sub>"

A58S Norde Platino Path C 20 mm <sup>(1)</sup>  
55x109 - 21<sup>1</sup>/<sub>8</sub>"x42<sup>7</sup>/<sub>8</sub>"

A58P Norde Piombo Path A+B 20mm <sup>(1)</sup>  
54x54 - 21<sup>1</sup>/<sub>4</sub>"x21<sup>1</sup>/<sub>4</sub>"

A58T Norde Piombo Path C 20mm <sup>(1)</sup>  
55x109 - 21<sup>1</sup>/<sub>8</sub>"x42<sup>7</sup>/<sub>8</sub>"

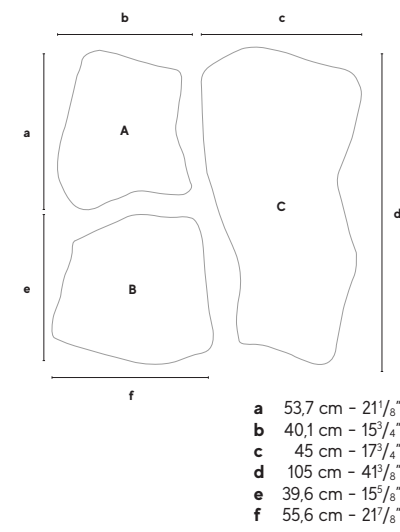

<sup>(1)</sup> We recommend "dry" installation on gravel and/or grass. - Si consiglia posa "a secco" su ghiaia e/o erba. - Pose « à sec » sur gravillons et/ou herbe conseillée. - Es wird eine Trockenverlegung auf Kies bzw. Rasen empfohlen. - Se recomienda colocación «en seco» sobre grava o hierba. - Рекомендуются «сухая» укладка на гравий и/или траву.



INDEX



A COMPLETE  
PRODUCT  
SYSTEM



PRODUCT  
FINDER



SURFACE  
RANGE



COMPANY



COLLECTIONS



3D WALL  
CONCRETE & RESIN LOOK  
METAL LOOK  
MARBLE LOOK  
STONE LOOK  
WOOD LOOK

LARGE SIZES



SLABS FOR  
COUNTERTOPS  
& FURNITURE



SINKS &  
BATHROOM  
FURNISHING



FACADES



TECHNICAL  
SPECIFICATIONS



# Trust



© Ceramiche Atlas Concorde



© Ceramiche Atlas Concorde



© Ceramiche Atlas Concorde

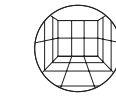

Floor & Wall



Outdoor

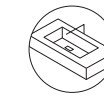

Sinks



Facades



## Porcelain Tiles RECTIFIED MONOCALIBER

Sizes	Thickness	Surface finish
60x60 cm - 23 <sup>5</sup> / <sub>8</sub> "x23 <sup>5</sup> / <sub>8</sub> "	± 9 mm	Matte Sensitech R10 B
30x60 cm - 11 <sup>3</sup> / <sub>4</sub> "x23 <sup>5</sup> / <sub>8</sub> "	± 9 mm	Matte Sensitech R10 B
OUTDOOR AND WET AREAS		
30x60 cm - 11 <sup>3</sup> / <sub>4</sub> "x23 <sup>5</sup> / <sub>8</sub> "	± 9 mm	Grip R12 C
60x120 cm - 23 <sup>5</sup> / <sub>8</sub> "x47 <sup>1</sup> / <sub>4</sub> "	± 20 mm	Outdoor R11 C
60x60 cm - 23 <sup>5</sup> / <sub>8</sub> "x23 <sup>5</sup> / <sub>8</sub> "	± 20 mm	Outdoor R11 C

INDEX



A COMPLETE PRODUCT SYSTEM >

PRODUCT FINDER >

SURFACE RANGE >

COMPANY >

COLLECTIONS >

- 3D WALL
- CONCRETE & RESIN LOOK
- METAL LOOK
- MARBLE LOOK
- STONE LOOK
- WOOD LOOK

LARGE SIZES >

SLABS FOR COUNTERTOPS & FURNITURE >

SINKS & BATHROOM FURNISHING >

FACADES >

TECHNICAL SPECIFICATIONS >

# Trust

## Porcelain Tiles

### MATTE SURFACE

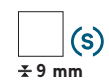

**± 9 mm**  
**60x60 cm** - 23<sup>5</sup>/<sub>8</sub>"x23<sup>5</sup>/<sub>8</sub>"  
 AA8C Trust Moon  
 ACI1 Trust Ivory  
 ACI3 Trust Gold  
 ACI4 Trust Silver  
 ACI5 Trust Copper  
 ACI6 Trust Titanium



**± 9 mm**  
**30x60 cm** - 11<sup>1</sup>/<sub>4</sub>"x23<sup>5</sup>/<sub>8</sub>"  
 D234 Trust Moon  
 D156 Trust Ivory  
 D157 Trust Gold  
 D158 Trust Silver  
 D159 Trust Copper  
 D160 Trust Titanium

### GRIP SURFACE



**± 9 mm**  
**30x60 cm** - 11<sup>3</sup>/<sub>4</sub>"x23<sup>5</sup>/<sub>8</sub>"  
 D235 Trust Moon Grip  
 D161 Trust Ivory Grip  
 D162 Trust Gold Grip  
 D163 Trust Silver Grip  
 D164 Trust Copper Grip  
 D165 Trust Titanium Grip

### OUTDOOR ± 20 mm



**± 20 mm**  
**60x120 cm** - 23<sup>5</sup>/<sub>8</sub>"x47<sup>1</sup>/<sub>4</sub>"  
 AY4E Trust Gold 20 mm  
 AY4D Trust Silver 20 mm  
 AY4F Trust Titanium 20 mm  
 AY4G Trust Ivory 20 mm

**H** Matte Sensitech (S) ± 9 mm  
 Grip ± 9 mm  
 Outdoor ± 20 mm  
**HEAVY TRAFFIC**

**R10 B** Matte Sensitech (S) ± 9 mm  
**R12 C** Grip ± 9 mm  
**R11 C** Outdoor ± 20 mm

V2 Slight Variation  
 Moon

V3 Moderate Variation  
 Ivory, Gold, Silver,  
 Copper, Titanium



MATTE / GRIP



OUTDOOR 20 mm



### TRIM TILES

p. 352

	Battiscopa	Gradino *	Scalino *	Scalino Ang.*	Battiscopa Sag. Scala *	Elemento L *
	7,5x30 cm 3"x11 <sup>1</sup> / <sub>4</sub> "	30x30 cm 11 <sup>3</sup> / <sub>4</sub> "x11 <sup>3</sup> / <sub>4</sub> "	33x60 cm 13"x23 <sup>5</sup> / <sub>8</sub> "	33x33 cm 13"x13"	7,5x30 cm 3"x11 <sup>1</sup> / <sub>4</sub> "	15x60 H. 4 cm 5 <sup>7</sup> / <sub>8</sub> "x23 <sup>5</sup> / <sub>8</sub> " H. 1 <sup>1</sup> / <sub>4</sub> "
	Matte	Matte	Matte	Matte	Matte	Grip
Moon	AAHW	AAHX	AAHY	AAHZ	DX AAHØ	AORD
Ivory	AD94	AD89	ACYU	ACYZ	AEAL	AORA
Gold	AD95	AD9Ø	ACYV	ACYØ	AEAN	AWRB
Silver	AD96	AD91	ACYW	ACY1	AEAP	AD3M
Copper	AD97	AD92	ACYX	ACY2	AEAR	AORB
Titanium	AD98	AD93	ACYY	ACY3	AEAU	AORC

\* These parts are supplied to order - I pezzi sono disponibili su ordinazione - Les pièces sont disponibles sur commande - Die Teile sind auf Bestellung lieferbar - Las piezas se hacen por encargo - Изготавливаются на заказ

### COMPLETE YOUR PROJECT

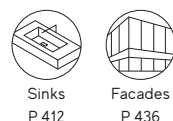

A COMPLETE PRODUCT SYSTEM >

PRODUCT FINDER >

SURFACE RANGE >

COMPANY >

COLLECTIONS >

3D WALL  
 CONCRETE & RESIN LOOK  
 METAL LOOK  
 MARBLE LOOK  
 STONE LOOK  
 WOOD LOOK

LARGE SIZES >

SLABS FOR COUNTERTOPS & FURNITURE >

SINKS & BATHROOM FURNISHING >

FACADES >

TECHNICAL SPECIFICATIONS >

# Trust

## Porcelain Tiles

### DECOR RANGE



ABDW Trust Moon Mosaico  
30x30 - 1 1/4"x1 1/4"

ACLA Trust Ivory Mosaico  
30x30 - 1 1/4"x1 1/4"

ACLC Trust Gold Mosaico  
30x30 - 1 1/4"x1 1/4"



ACLD Trust Silver Mosaico  
30x30 - 1 1/4"x1 1/4"

ACLE Trust Copper Mosaico  
30x30 - 1 1/4"x1 1/4"

ACLF Trust Titanium Mosaico  
30x30 - 1 1/4"x1 1/4"



ABDX Trust Moon Brick  
30x60 - 1 1/4"x2 3/8"

ACNA Trust Ivory Brick  
30x60 - 1 1/4"x2 3/8"



ACNB Trust Gold Brick  
30x60 - 1 1/4"x2 3/8"

ACNC Trust Silver Brick  
30x60 - 1 1/4"x2 3/8"



ACND Trust Copper Brick  
30x60 - 1 1/4"x2 3/8"

ACNE Trust Titanium Brick  
30x60 - 1 1/4"x2 3/8"

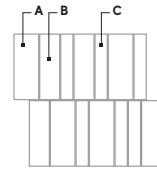

- A 5,6x14,7 cm - 2 1/4"x5 7/8"
- B 4,5x14,7 cm - 1 3/4"x5 7/8"
- C 2,8x14,7 cm - 1 1/8"x5 7/8"

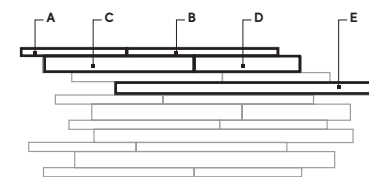

- A 2,1x24,8 cm - 3/4"x9 7/8"
- B 2,1x34,5 cm - 3/4"x13 3/8"
- C 3,3x34,5 cm - 1 1/4"x13 3/8"
- D 3,3x24,8 cm - 1 1/4"x9 7/8"
- E 2,5x60 cm - 1"x23 3/8"



© Ceramiche Atlas Concorde



© Ceramiche Atlas Concorde

INDEX



A COMPLETE PRODUCT SYSTEM



PRODUCT FINDER



SURFACE RANGE



COMPANY



COLLECTIONS



3D WALL  
CONCRETE & RESIN LOOK  
METAL LOOK  
MARBLE LOOK  
STONE LOOK  
WOOD LOOK

LARGE SIZES



SLABS FOR COUNTERTOPS & FURNITURE



SINKS & BATHROOM FURNISHING



FACADES



TECHNICAL SPECIFICATIONS



# Axi



© Ceramiche Atlas Concorde



© Ceramiche Atlas Concorde



© Ceramiche Atlas Concorde

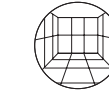

Floor & Wall

## Porcelain Tiles RECTIFIED MONOCALIBER

<b>Sizes</b>	<b>Thickness</b>	<b>Surface finish</b>
22,5x90 cm - 8 7/8"x35 3/8"	± 9,5 mm	Matte R10 B



WHITE PINE



SILVER FIR

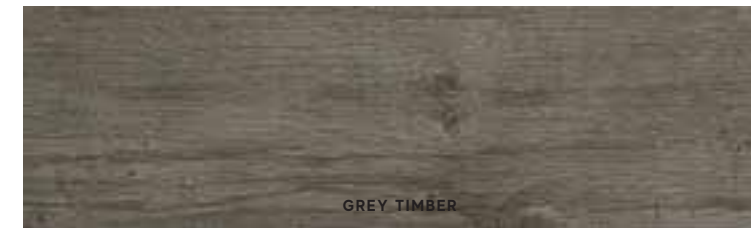

GREY TIMBER



GOLDEN OAK

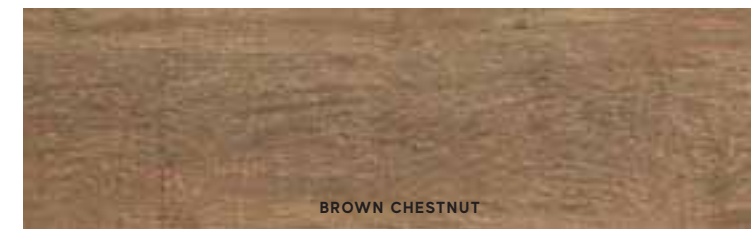

BROWN CHESTNUT

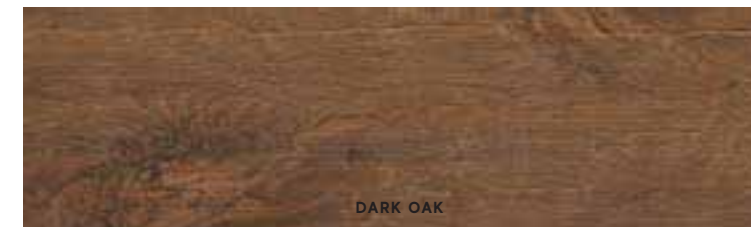

DARK OAK

INDEX



A COMPLETE PRODUCT SYSTEM >

PRODUCT FINDER >

SURFACE RANGE >

COMPANY >

COLLECTIONS >

- 3D WALL
- CONCRETE & RESIN LOOK
- METAL LOOK
- MARBLE LOOK
- STONE LOOK
- WOOD LOOK

LARGE SIZES >

SLABS FOR COUNTERTOPS & FURNITURE >

SINKS & BATHROOM FURNISHING >

FACADES >

TECHNICAL SPECIFICATIONS >

# Axi

## Porcelain Tiles



Matte ± 9,5 mm



RIO B Matte ± 9,5 mm



V2 Slight Variation  
White Pine,  
Silver Fir,  
Grey Timber,  
Dark Oak

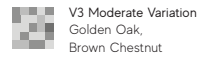

V3 Moderate Variation  
Golden Oak,  
Brown Chestnut



### MATTE SURFACE



WHITE PINE

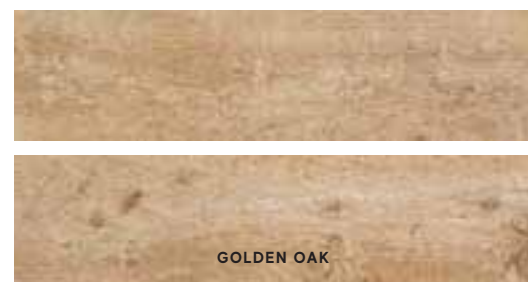

GOLDEN OAK



SILVER FIR



BROWN CHESTNUT



GREY TIMBER



DARK OAK

± 9,5 mm  
22,5x90 cm - 8 7/8" x 35 3/8"  
AS3B Axi White Pine  
AS3D Axi Silver Fir  
AS3E Axi Grey Timber  
AS3C Axi Golden Oak  
AS3A Axi Brown Chestnut  
AS3F Axi Dark Oak

### TRIM TILES p. 352

#### Battiscopa

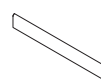

7,2x90 cm  
2 7/8" x 35 3/8"

Matte

White Pine  
Silver Fir  
Golden Oak  
Brown Chestnut  
Dark Oak  
Grey Timber

ANLH  
ANLK  
ANLJ  
ANLM  
ANLN  
ANLL

#### Scalino \*

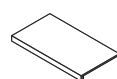

22,5x90 cm  
8 7/8" x 35 3/8"

Matte

ANLO  
ANLQ  
ANLP  
ANLT  
ANLU  
ANLR

#### Scalino Ang.\*

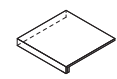

22,5x22,5 cm  
8 7/8" x 8 7/8"

Matte

DX	SX
ANLV	ANL1
ANLX	ANL2
ANLW	ANL5
ANLZ	ANL9
ANLØ	ANL7
ANLØ	ANL4
ANLY	ANL8

#### Battiscopa Sag. Scala \*



7,2x30 cm  
2 7/8" x 11 3/4"

Matte

DX	SX
ANMA	ANMG
ANMC	ANML
ANMB	ANMJ
ANME	ANMH
ANMF	ANMI
ANMD	ANMK

\* These parts are supplied to order - I pezzi sono disponibili su ordinazione - Les pièces sont disponibles sur commande - Die Teile sind auf Bestellung lieferbar - Las piezas se hacen por encargo - Изготавливаются на заказ

<sup>(1)</sup> Multi-thickness mosaic, close joint installation without grouting. - Mosaico multispessore, posa senza stuccatura a giunto unito. - Mosaïque multi-épaisseur, pose sans mastic avec joint nul. - Mosaik mit verschieden Stärken, fugenlose Verlegung ohne Mörtel. - Mosaico multiespesor, colocación sin mástique y sin juntas. - Мозаика разной толщины, укладка встык без затирки швов.

<sup>(2)</sup> The decoration can only be laid on the wall - Il decoro si può posare solo a rivestimento - Décor uniquement mural - Das Dekor kann nur an der Wand verlegt werden. La decoración se puede colocar únicamente en paredes - Декор может быть уложен только на стену.

### DECOR RANGE



AMWG Axi  
White Pine Tatami  
22,5x90 - 8 7/8" x 35 3/8"



AMWI Axi  
Silver Fir Tatami  
22,5x90 - 8 7/8" x 35 3/8"



AMWJ Axi  
Grey Timber Tatami  
22,5x90 - 8 7/8" x 35 3/8"



AMWH Axi  
Golden Oak Tatami  
22,5x90 - 8 7/8" x 35 3/8"



AMWK Axi  
Brown Chestnut Tatami  
22,5x90 - 8 7/8" x 35 3/8"



AMWL Axi  
Dark Oak Tatami  
22,5x90 - 8 7/8" x 35 3/8"

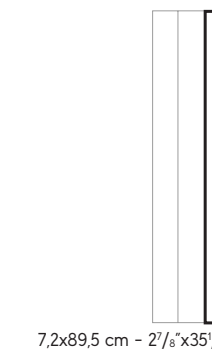

7,2x89,5 cm - 2 7/8" x 35 1/4"



AMWM Axi  
White Pine Treccia  
28x53 - 11" x 20 7/8"



AMWO Axi  
Silver Fir Treccia  
28x53 - 11" x 20 7/8"



AMWP Axi  
Grey Timber Treccia  
28x53 - 11" x 20 7/8"



AMWN Axi  
Golden Oak Treccia  
28x53 - 11" x 20 7/8"



AMWQ Axi  
Brown Chestnut Treccia  
28x53 - 11" x 20 7/8"



AMWR Axi  
Dark Oak Treccia  
28x53 - 11" x 20 7/8"

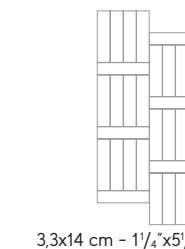

3,3x14 cm - 1 1/4" x 5 1/2"



AMV7 Axi White Pine  
Mosaico 3D <sup>(1)</sup>  
35x35 - 13 3/4" x 13 3/4"



AMV1 Axi Silver Fir  
Mosaico 3D <sup>(1)</sup>  
35x35 - 13 3/4" x 13 3/4"



AMV4 Axi Grey Timber  
Mosaico 3D <sup>(1)</sup>  
35x35 - 13 3/4" x 13 3/4"



AMVØ Axi Golden Oak  
Mosaico 3D <sup>(1)</sup>  
35x35 - 13 3/4" x 13 3/4"



AMV8 Axi Brown Chestnut  
Mosaico 3D <sup>(1)</sup>  
35x35 - 13 3/4" x 13 3/4"



AMV9 Axi Dark Oak  
Mosaico 3D <sup>(1)</sup>  
35x35 - 13 3/4" x 13 3/4"



6,9x6,9 cm - 2 3/4" x 2 3/4"



AMWA Axi White Pine  
Brick 3D <sup>(1)</sup>  
20x44 - 7 7/8" x 17 1/8"



AMWC Axi Silver Fir  
Brick 3D <sup>(1)</sup>  
20x44 - 7 7/8" x 17 1/8"



AMWD Axi Grey Timber  
Brick 3D <sup>(1)</sup>  
20x44 - 7 7/8" x 17 1/8"



AMWB Axi Golden Oak  
Brick 3D <sup>(1)</sup>  
20x44 - 7 7/8" x 17 1/8"



AMWE Axi Brown Chestnut  
Brick 3D <sup>(1)</sup>  
20x44 - 7 7/8" x 17 1/8"



AMWF Axi Dark Oak  
Brick 3D <sup>(1)</sup>  
20x44 - 7 7/8" x 17 1/8"

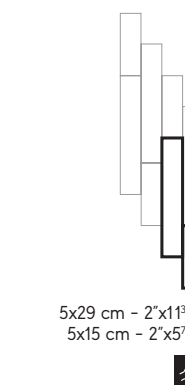

5x29 cm - 2" x 11 1/8"  
5x15 cm - 2" x 5 7/8"

# Entice



© Ceramiche Atlas Concorde



© Ceramiche Atlas Concorde



© Ceramiche Atlas Concorde

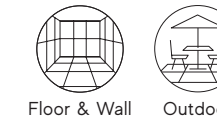

Floor & Wall Outdoor

## Porcelain Tiles RECTIFIED MONOCALIBER

### NATURAL

Sizes	Thickness	Surface finish
18,5x150 cm - 7 1/4"x59"	± 9 mm	Matte <b>Sensitech R10 B</b>
20x120 cm - 7 7/8"x47 1/4"	± 9 mm	Matte <b>Sensitech R10 B</b>

### OUTDOOR AND WET AREAS

20x120 cm - 7 7/8"x47 1/4"	± 9 mm	Grip <b>R11 C</b>
30x120 cm - 11 3/4"x47 1/4"	± 20 mm	Outdoor <b>R11 C</b>

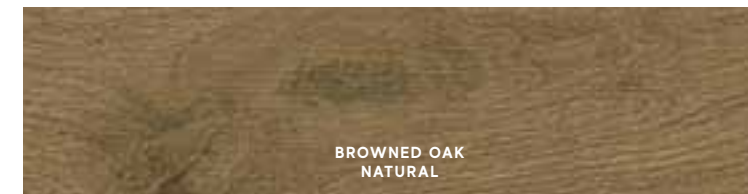
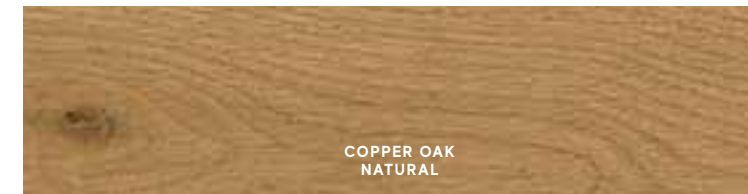

### ELEGANT

Sizes	Thickness	Surface finish
18,5x150 cm - 7 1/4"x59"	± 9 mm	Matte <b>R9 A</b>

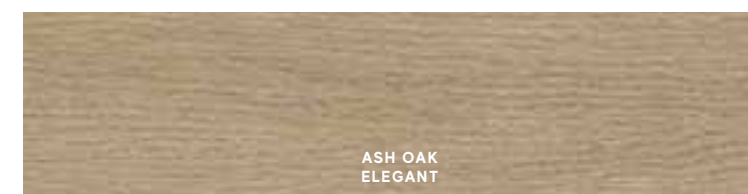
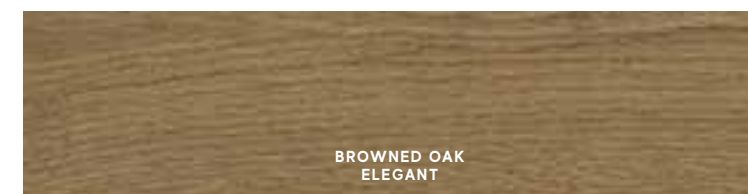
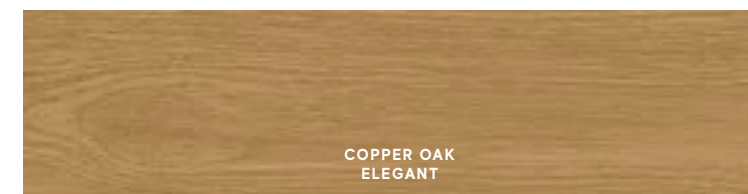
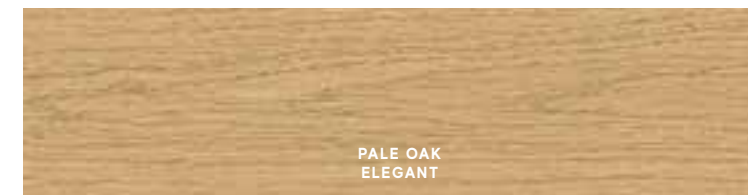

INDEX



A COMPLETE  
PRODUCT  
SYSTEM



PRODUCT  
FINDER



SURFACE  
RANGE



COMPANY



COLLECTIONS



3D WALL  
CONCRETE & RESIN LOOK  
METAL LOOK  
MARBLE LOOK  
STONE LOOK  
WOOD LOOK

LARGE SIZES



SLABS FOR  
COUNTERTOPS  
& FURNITURE



SINKS &  
BATHROOM  
FURNISHING



FACADES



TECHNICAL  
SPECIFICATIONS





# Entice

## Porcelain Tiles

**H** HEAVY TRAFFIC  
Matte ± 9 mm  
Matte Sensitech (S) ± 9 mm

**R9 A** Matte ± 9 mm ELEGANT  
**R10 B** Matte Sensitech (S) ± 9 mm NATURAL

V2 Slight Variation



### MATTE SURFACE - ELEGANT



PALE OAK ELEGANT



COPPER OAK ELEGANT



BROWNEOAK ELEGANT

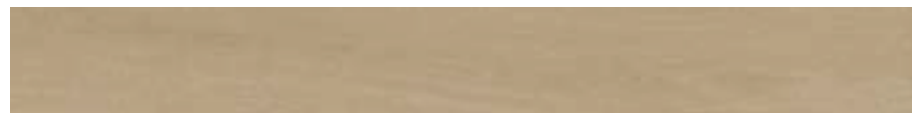

ASH OAK ELEGANT

± 9 mm  
18,5x150 cm - 7 1/4" x 59"  
A8YB Entice Pale Oak Elegant  
A8YC Entice Copper Oak Elegant  
A8YD Entice Browned Oak Elegant  
A8YE Entice Ash Oak Elegant

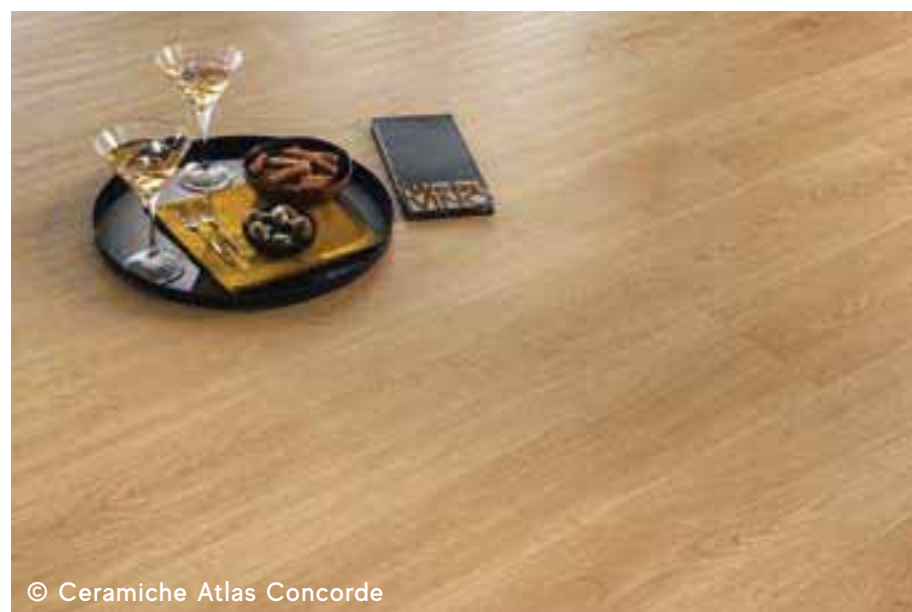

© Ceramiche Atlas Concorde

### MATTE SURFACE - NATURAL



PALE OAK NATURAL



COPPER OAK NATURAL



BROWNEOAK NATURAL



ASH OAK NATURAL

± 9 mm (S)  
18,5x150 cm - 7 1/4" x 59"  
A8X6 Entice Pale Oak Natural  
A8X7 Entice Copper Oak Natural  
A8X9 Entice Browned Oak Natural  
A8YA Entice Ash Oak Natural

± 9 mm (S)  
20x120 cm - 7 7/8" x 47 1/4"  
A841 Entice Pale Oak Natural  
A84Y Entice Copper Oak Natural  
A84Z Entice Browned Oak Natural  
A84Ø Entice Ash Oak Natural

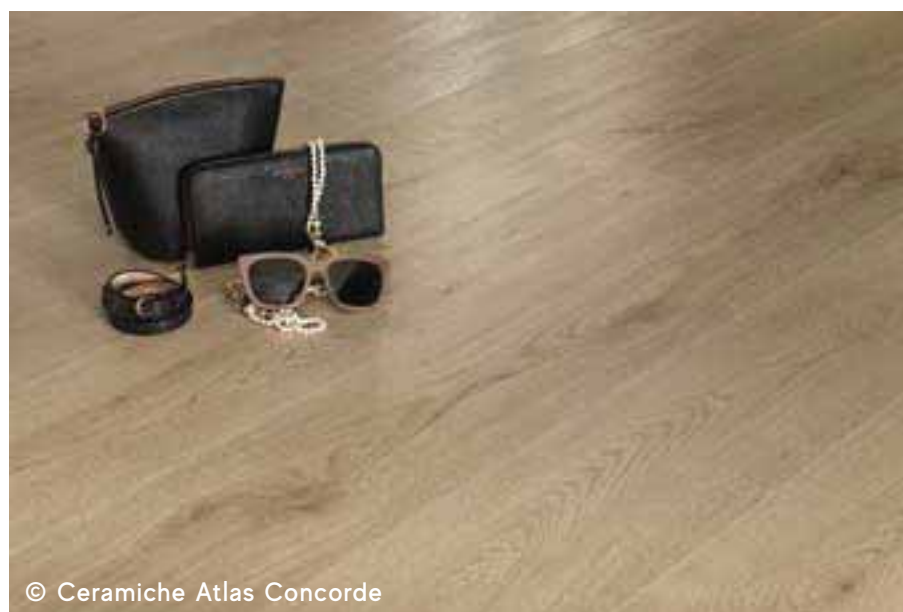

© Ceramiche Atlas Concorde

**Sensitech** SAFE, SOFT, SMART. P.470

INDEX



A COMPLETE PRODUCT SYSTEM >

PRODUCT FINDER >

SURFACE RANGE >

COMPANY >

COLLECTIONS >

3D WALL  
CONCRETE & RESIN LOOK  
METAL LOOK  
MARBLE LOOK  
STONE LOOK  
WOOD LOOK

LARGE SIZES >

SLABS FOR COUNTERTOPS & FURNITURE >

SINKS & BATHROOM FURNISHING >

FACADES >

TECHNICAL SPECIFICATIONS >

# Entice

## Porcelain Tiles

### GRIP SURFACE - NATURAL

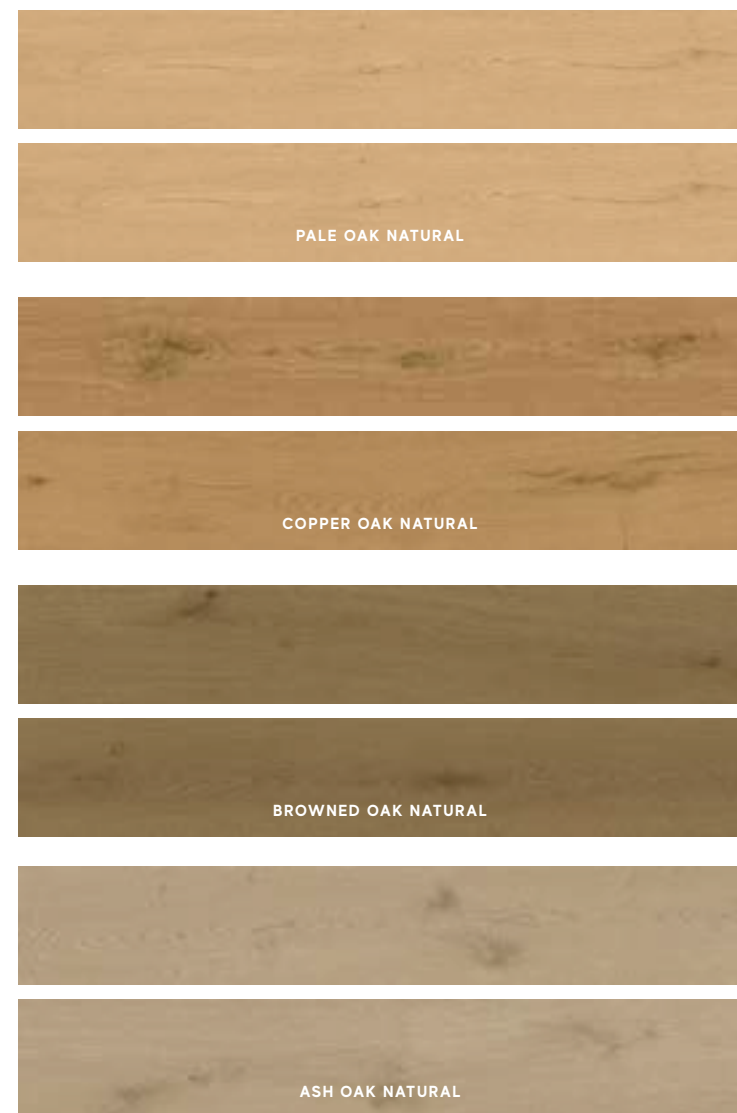

± 9 mm  
**20x120 cm - 7<sup>7</sup>/<sub>8</sub>"x47<sup>1</sup>/<sub>4</sub>"**  
 A842 Entice Pale Oak Natural Grip  
 A843 Entice Copper Oak Natural Grip  
 A844 Entice Browned Oak Natural Grip  
 A845 Entice Ash Oak Natural Grip

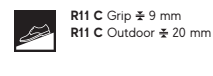

### OUTDOOR ± 20 mm - NATURAL

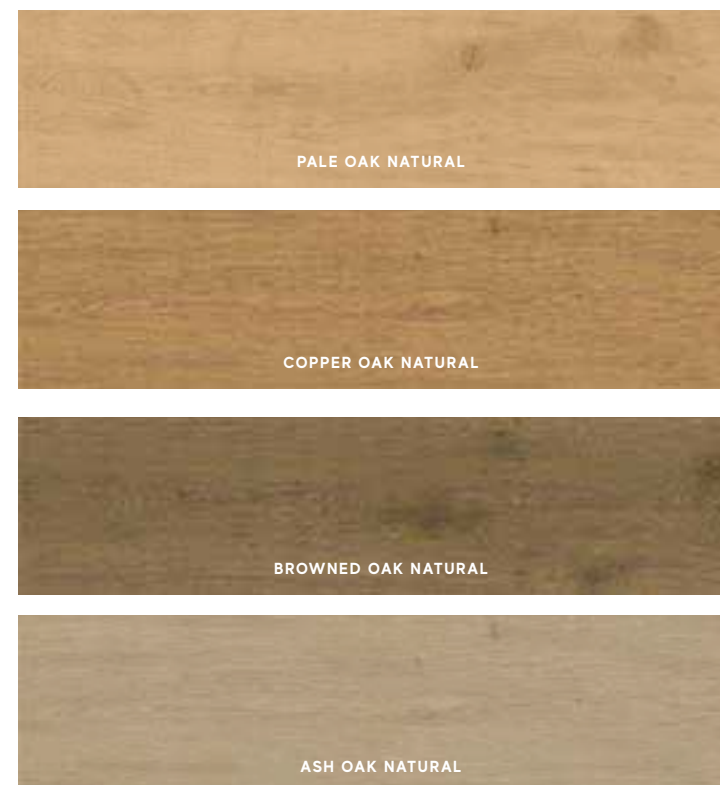

± 20 mm  
**30x120 cm - 11<sup>3</sup>/<sub>4</sub>"x47<sup>1</sup>/<sub>4</sub>"**  
 A9DD Entice Pale Oak Natural 20 mm  
 A9DE Entice Copper Oak Natural 20 mm  
 A9DF Entice Browned Oak Natural 20 mm  
 A9DG Entice Ash Oak Natural 20 mm

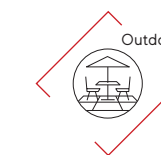

INDEX



A COMPLETE PRODUCT SYSTEM



PRODUCT FINDER



SURFACE RANGE



COMPANY



COLLECTIONS



3D WALL  
 CONCRETE & RESIN LOOK  
 METAL LOOK  
 MARBLE LOOK  
 STONE LOOK  
 WOOD LOOK

LARGE SIZES



SLABS FOR COUNTERTOPS & FURNITURE



SINKS & BATHROOM FURNISHING



FACADES



TECHNICAL SPECIFICATIONS



#### TRIM TILES p. 352

	Battiscopa		Scalino *		Battiscopa Sag. Scala *		Elemento L *
	7,2x150 cm 2 <sup>7</sup> / <sub>8</sub> "x59"	6,5x120 cm 2 <sup>1</sup> / <sub>2</sub> "x47 <sup>1</sup> / <sub>4</sub> "	33x150 cm 13"x59"	33x120 cm 13"x47 <sup>1</sup> / <sub>4</sub> "	7,2x30 cm 2 <sup>7</sup> / <sub>8</sub> "x11 <sup>3</sup> / <sub>4</sub> "		20x120 H. 4 cm 7 <sup>7</sup> / <sub>8</sub> "x59" H. 1 <sup>1</sup> / <sub>8</sub> "
	Matte	Matte	Matte		Matte		Grip
Pale Oak Natural	A85B	AHAB	AFI0	AFI9	DX A85N	SX A85J	AFJD
Copper Oak Natural	A85C	AHAA	AFI1	AFJA	A85O	A85K	AFJE
Browned Oak Natural	A85D	AG95	AFI3	AFJB	A85P	A85L	AFJF
Ash Oak Natural	A85E	AG94	AFI4	AFJC	A85Q	A85M	AFJG
Pale Oak Elegant	A85F	-	AFI5	-	-	-	-
Copper Oak Elegant	A85G	-	AFI6	-	-	-	-
Browned Oak Elegant	A85H	-	AFI7	-	-	-	-
Ash Oak Elegant	A85I	-	AFI8	-	-	-	-

\* These parts are supplied to order - I pezzi sono disponibili su ordinazione - Les pièces sont disponibles sur commande - Die Teile sind auf Bestellung lieferbar - Las piezas se hacen por encargo - Изготавливаются на заказ

# Etic



© Ceramiche Atlas Concorde



© Ceramiche Atlas Concorde

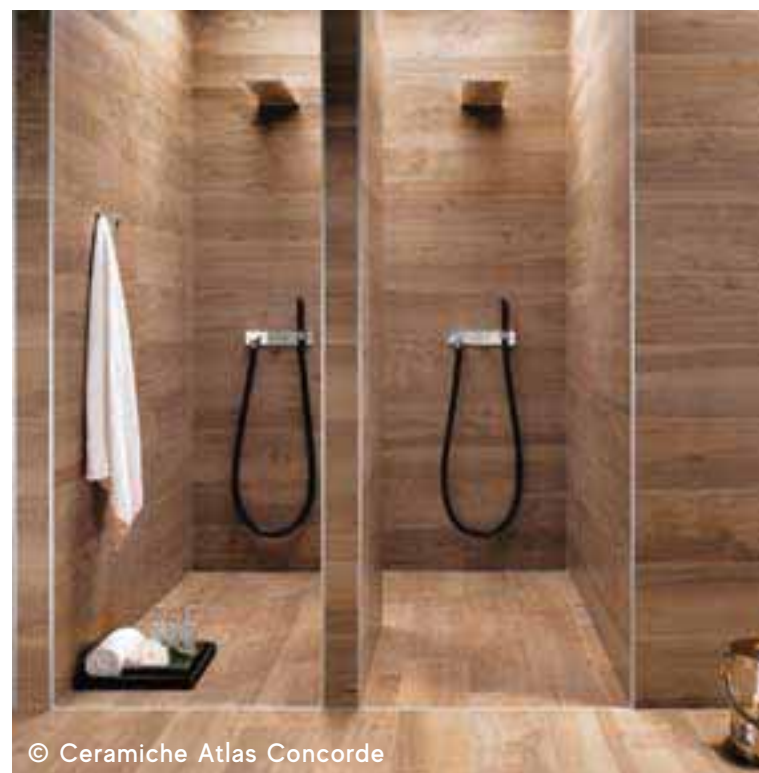

© Ceramiche Atlas Concorde

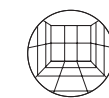

Floor & Wall

## Porcelain Tiles RECTIFIED MONOCALIBER

<b>Sizes</b>	<b>Thickness</b>	<b>Surface finish</b>
22,5x90 cm - 8 7/8"x35 3/8"	± 9,5 mm	Matte R9 A

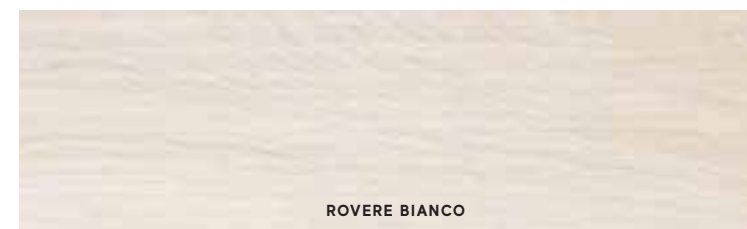

ROVERE BIANCO



ROVERE

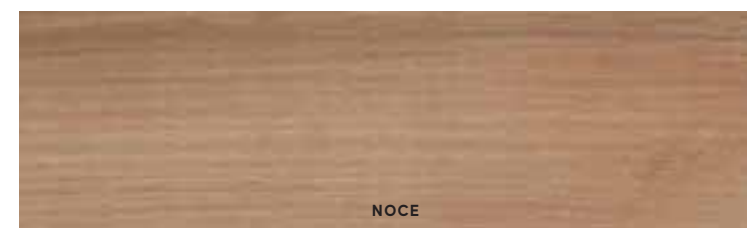

NOCE

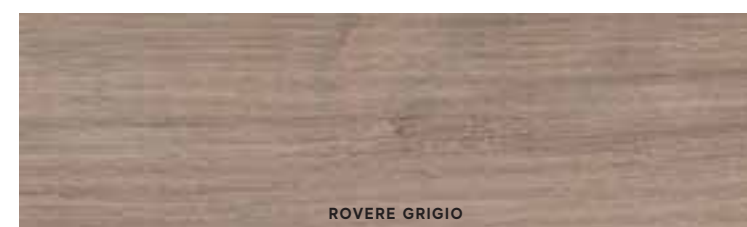

ROVERE GRIGIO

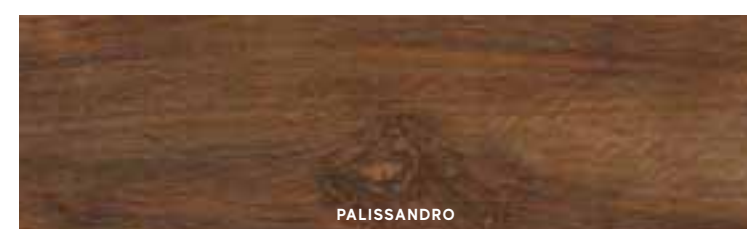

PALISSANDRO

INDEX



A COMPLETE PRODUCT SYSTEM >

PRODUCT FINDER >

SURFACE RANGE >

COMPANY >

COLLECTIONS >

- 3D WALL
- CONCRETE & RESIN LOOK
- METAL LOOK
- MARBLE LOOK
- STONE LOOK
- WOOD LOOK

LARGE SIZES >

SLABS FOR COUNTERTOPS & FURNITURE >

SINKS & BATHROOM FURNISHING >

FACADES >

TECHNICAL SPECIFICATIONS >

# Etic

## Porcelain Tiles

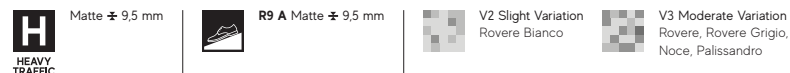

### MATTE SURFACE

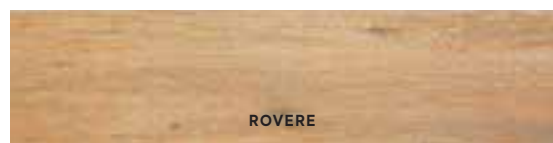

ROVERE

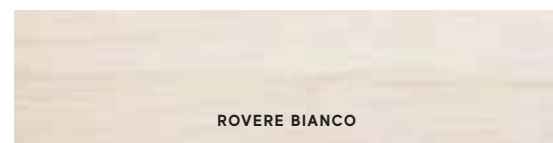

ROVERE BIANCO

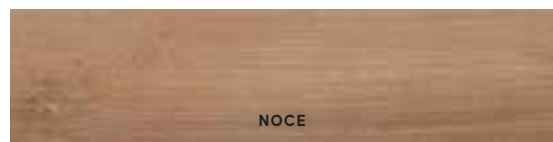

NOCE

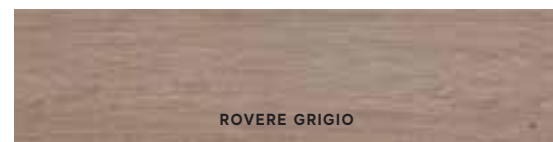

ROVERE GRIGIO

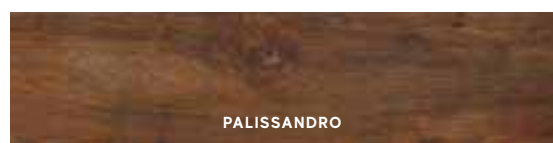

PALISSANDRO

± 9.5 mm  
 22,5x90 cm - 8 7/8"x35 3/8"  
 AJ8D Etic Rovere  
 AJ8F Etic Noce  
 AJ8G Etic Palissandro  
 AJ78 Etic Rovere Bianco  
 AJ8H Etic Rovere Grigio

### DECOR RANGE



AM8D Etic Rovere  
Tatami  
22,5x90 - 8 7/8"x35 3/8"



AM8F Etic Noce  
Tatami  
22,5x90 - 8 7/8"x35 3/8"



AM8H Etic Palissandro  
Tatami  
22,5x90 - 8 7/8"x35 3/8"



AM8C Etic Rovere Bianco  
Tatami  
22,5x90 - 8 7/8"x35 3/8"



AM8G Etic Rovere Grigio  
Tatami  
22,5x90 - 8 7/8"x35 3/8"

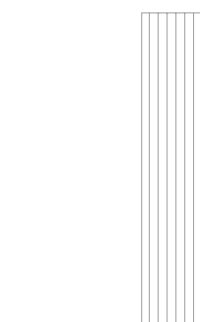

2,3x90 cm - 7/8"x35 3/8"

### TRIM TILES p. 352

#### Battiscopa

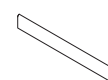

7,2x90 cm  
2 7/8"x35 3/8"  
Matte

#### Scalino \*

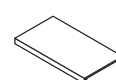

22,5x90 cm  
8 7/8"x35 3/8"  
Matte

#### Scalino Ang.\*

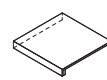

22,5x22,5 cm  
8 7/8"x8 7/8"  
Matte

#### Battiscopa Sag. Scala \*



7,2x30 cm  
2 7/8"x11 1/4"  
Matte

Rovere Bianco  
Rovere  
Noce  
Rovere Grigio  
Palissandro

AM75  
AM76  
AM78  
AM79  
AM8A

AM96  
AM97  
AM99  
ANAA  
ANAC

DX  
ANAE  
ANAF  
ANAH  
ANAI  
ANAJ

SX  
ANCV  
ANCW  
ANCZ  
ANC1  
ANCØ

DX  
ANAL  
ANCH  
ANCJ  
ANCK  
ANCL

SX  
ANCN  
ANCO  
ANCQ  
ANCR  
ANCS

\* These parts are supplied to order - I pezzi sono disponibili su ordinazione - Les pièces sont disponibles sur commande - Die Teile sind auf Bestellung lieferbar - Las piezas se hacen por encargo - Изготавливаются на заказ

INDEX



A COMPLETE  
PRODUCT  
SYSTEM



PRODUCT  
FINDER



SURFACE  
RANGE



COMPANY



COLLECTIONS



3D WALL  
CONCRETE & RESIN LOOK  
METAL LOOK  
MARBLE LOOK  
STONE LOOK  
WOOD LOOK

LARGE SIZES



SLABS FOR  
COUNTERTOPS  
& FURNITURE



SINKS &  
BATHROOM  
FURNISHING



FACADES



TECHNICAL  
SPECIFICATIONS



# Etic Pro



© Ceramiche Atlas Concorde



© Ceramiche Atlas Concorde



© Ceramiche Atlas Concorde

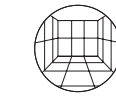

Floor & Wall



Outdoor



ROVERE VENICE

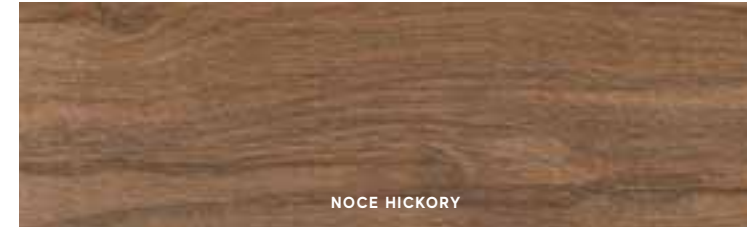

NOCE HICKORY

## Porcelain Tiles RECTIFIED MONOCALIBER

Sizes	Thickness	Surface finish
25x150 cm - 9 <sup>7</sup> / <sub>8</sub> "x59"	± 9 mm	Matte R9 A
22,5x90 cm - 8 <sup>7</sup> / <sub>8</sub> "x35 <sup>7</sup> / <sub>8</sub> "	± 9 mm	Matte R9 A
<b>OUTDOOR AND WET AREAS</b>		
22,5x90 cm - 8 <sup>7</sup> / <sub>8</sub> "x35 <sup>7</sup> / <sub>8</sub> "	± 9 mm	Grip R11 C
30x120 cm - 11 <sup>1</sup> / <sub>4</sub> "x47 <sup>1</sup> / <sub>4</sub> "	± 20 mm	Outdoor R11 C

INDEX

A COMPLETE PRODUCT SYSTEM

PRODUCT FINDER

SURFACE RANGE

COMPANY

COLLECTIONS

- 3D WALL
- CONCRETE & RESIN LOOK
- METAL LOOK
- MARBLE LOOK
- STONE LOOK
- WOOD LOOK

LARGE SIZES

SLABS FOR COUNTERTOPS & FURNITURE

SINKS & BATHROOM FURNISHING

FACADES

TECHNICAL SPECIFICATIONS

# Etic Pro

## Porcelain Tiles

### MATTE SURFACE

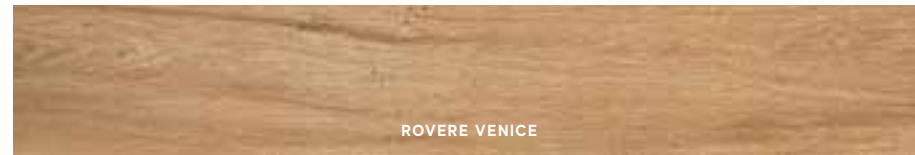

ROVERE VENICE



NOCE HICKORY

**± 9 mm**  
**25x150 cm** - 9<sup>7/8</sup>"x59"  
 AV4I Etic Rovere Venice  
 AV4K Etic Noce Hickory

**± 9 mm**  
**22,5x90 cm** - 8<sup>7/8</sup>"x35<sup>3/8</sup>"  
 AV4M Etic Rovere Venice  
 AV4O Etic Noce Hickory

**H** HEAVY TRAFFIC  
 Matte ± 9 mm  
 Grip ± 9 mm  
 Outdoor ± 20 mm

**R9 A** Matte ± 9 mm  
**R11 C** Grip ± 9 mm  
**R11 C** Outdoor ± 20 mm

V3 Moderate Variation



### GRIP SURFACE



ROVERE VENICE

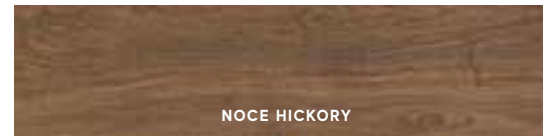

NOCE HICKORY

**± 9 mm**  
**22,5x90 cm** - 8<sup>7/8</sup>"x35<sup>3/8</sup>"  
 AV4Y Etic Rovere Venice Grip  
 AV4Ø Etic Noce Hickory Grip

### OUTDOOR ± 20 mm

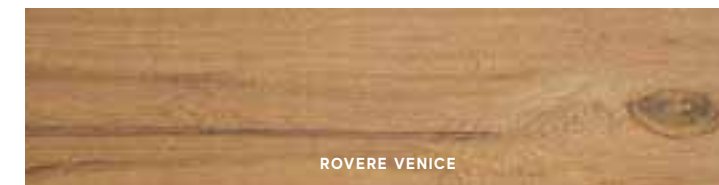

ROVERE VENICE



NOCE HICKORY

**± 20 mm**  
**30x120 cm** - 11<sup>3/4</sup>"x47<sup>1/4</sup>"  
 AV42 Etic Rovere Venice 20mm  
 AV44 Etic Noce Hickory 20mm



### TRIM TILES p. 352

#### Battiscopa

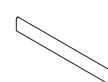

7,2x90 cm  
 2<sup>7/8</sup>"x35<sup>3/8</sup>"  
 Matte

#### Scalino \*

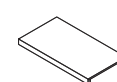

22,5x90 cm  
 8<sup>7/8</sup>"x35<sup>3/8</sup>"  
 Matte

#### Scalino \*

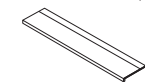

33x150 cm  
 13"x59"  
 Matte

#### Scalino Ang.\*

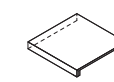

22,5x22,5 cm  
 8<sup>7/8</sup>"x8<sup>7/8</sup>"  
 Matte

#### Battiscopa Sag. Scala \*



7,2x30 cm  
 2<sup>7/8</sup>"x11<sup>3/4</sup>"  
 Matte

#### Elemento L \*

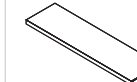

22,5x90 H. 4 cm  
 8<sup>7/8</sup>"x35<sup>3/8</sup>" H. 1<sup>1/8</sup>"  
 Grip

Rovere Venice  
 Noce Hickory

AV68  
 AV7A

AV7Z  
 AV71

AZFC  
 AZSH

DX  
 AV78  
 AV8A

SX  
 AV73  
 AV75

DX  
 AV8G  
 AV8I

SX  
 AV8C  
 AV8E

AV8K  
 AV8M

\* These parts are supplied to order - I pezzi sono disponibili su ordinazione - Les pièces sont disponibles sur commande - Die Teile sind auf Bestellung lieferbar - Las piezas se hacen por encargo - Изготавливаются на заказ

# Etic Pro

## Porcelain Tiles



AWVZ Etic Rovere Venice  
Tatami  
22,5x90 - 8<sup>7</sup>/<sub>8</sub>"x35<sup>3</sup>/<sub>8</sub>"



AWV1 Etic Noce Hickory  
Tatami  
22,5x90 - 8<sup>7</sup>/<sub>8</sub>"x35<sup>3</sup>/<sub>8</sub>"



2,3x90 cm - 7<sup>1</sup>/<sub>8</sub>"x35<sup>3</sup>/<sub>8</sub>"



AWY1 Etic Rovere Venice  
Industrial 3D<sup>(1)</sup>  
44x28,5 - 17<sup>3</sup>/<sub>8</sub>"x11<sup>1</sup>/<sub>4</sub>"



AWYK Etic Noce Hickory  
Industrial 3D<sup>(1)</sup>  
44x28,5 - 17<sup>3</sup>/<sub>8</sub>"x11<sup>1</sup>/<sub>4</sub>"

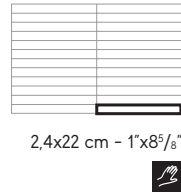

2,4x22 cm - 1"x8<sup>5</sup>/<sub>8</sub>"



AWV3 Etic Rovere Venice  
Herringbone  
36,2x41,2 - 14<sup>1</sup>/<sub>8</sub>"x16<sup>1</sup>/<sub>8</sub>"



AWV5 Etic Noce Hickory  
Herringbone  
36,2x41,2 - 14<sup>1</sup>/<sub>8</sub>"x16<sup>1</sup>/<sub>8</sub>"

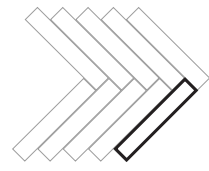

4,9x29 cm - 1<sup>7</sup>/<sub>8</sub>"x11<sup>1</sup>/<sub>8</sub>"



AWV7 Etic Rovere Venice  
Chevron A+B  
35x34,5 - 13<sup>3</sup>/<sub>4</sub>"x13<sup>3</sup>/<sub>8</sub>"



AWV9 Etic Noce Hickory  
Chevron A+B  
35x34,5 - 13<sup>3</sup>/<sub>4</sub>"x13<sup>3</sup>/<sub>8</sub>"

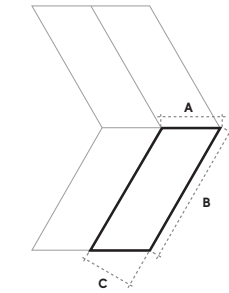

A 17 cm - 6<sup>3</sup>/<sub>4</sub>"  
B 39,8 cm - 15<sup>5</sup>/<sub>8</sub>"  
C 14,7 cm - 5<sup>3</sup>/<sub>4</sub>"



AWYE Etic Rovere Venice  
Chevron Tatami A+B  
74x22,2 - 29<sup>1</sup>/<sub>8</sub>"x8<sup>5</sup>/<sub>8</sub>"



AWYG Etic Noce Hickory  
Chevron Tatami A+B  
74x22,2 - 29<sup>1</sup>/<sub>8</sub>"x8<sup>5</sup>/<sub>8</sub>"

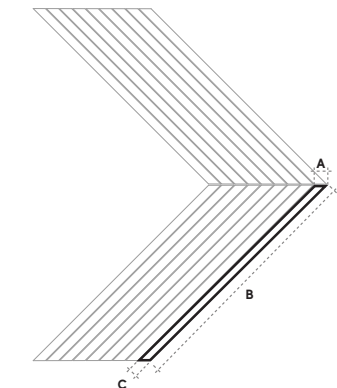

A 3,2 cm - 1<sup>1</sup>/<sub>4</sub>"  
B 73,8 cm - 29"  
C 2,3 cm - 7<sup>1</sup>/<sub>8</sub>"

<sup>(1)</sup> Multi-thickness mosaic, close joint installation without grouting. - Mosaico multispessore, posa senza stuccatura a giunto unito. - Mosaïque multi-épaisseur, pose sans mastic avec joint nul. - Mosaik mit verschiedenen Stärken, fugenlose Verlegung ohne Mörtel. - Mosaico multiespesor, colocación sin mástique y sin juntas. - Мозаика разной толщины, укладка встык без затирки швов.

The decoration can only be laid on the wall - Il decoro si può posare solo a rivestimento - Décor uniquement mural - Das Dekor kann nur an der Wand verlegt werden. La decoración se puede colocar únicamente en paredes - Декор может быть уложен только на стену.

INDEX



A COMPLETE  
PRODUCT  
SYSTEM



PRODUCT  
FINDER



SURFACE  
RANGE



COMPANY



COLLECTIONS



3D WALL  
CONCRETE & RESIN LOOK  
METAL LOOK  
MARBLE LOOK  
STONE LOOK  
WOOD LOOK

LARGE SIZES



SLABS FOR  
COUNTERTOPS  
& FURNITURE



SINKS &  
BATHROOM  
FURNISHING



FACADES



TECHNICAL  
SPECIFICATIONS



# Exence



© Ceramiche Atlas Concorde



© Ceramiche Atlas Concorde



© Ceramiche Atlas Concorde

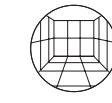

Floor & Wall



Outdoor

## Porcelain Tiles RECTIFIED MONOCALIBER

Sizes	Thickness	Surface finish
18,5x150 cm - 7 1/4"x59"	± 9 mm	Matte Sensitech R10 B
20x120 cm - 7 7/8"x47 1/4"	± 9 mm	Matte Sensitech R10 B

### OUTDOOR AND WET AREAS

18,5x150 cm - 7 1/4"x59"	± 9 mm	Grip R11 C
30x120 cm - 11 3/4"x47 1/4"	± 20 mm	Outdoor R11 C



VANILLA



ALMOND

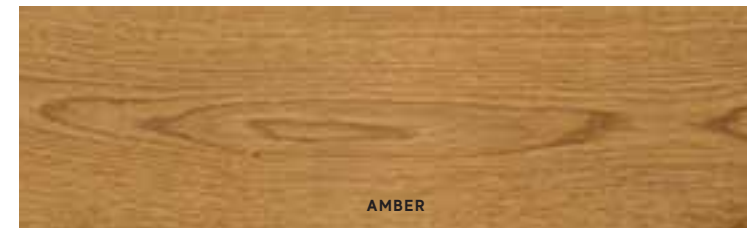

AMBER



VANILLA SAW CUT



ALMOND SAW CUT

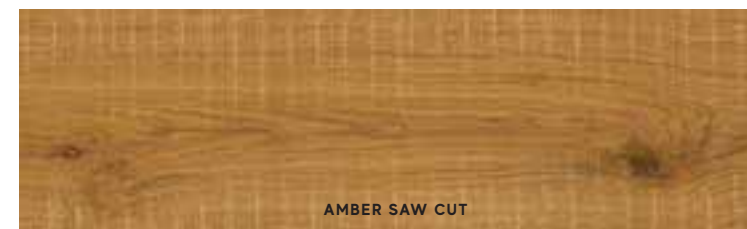

AMBER SAW CUT

INDEX



A COMPLETE PRODUCT SYSTEM >

PRODUCT FINDER >

SURFACE RANGE >

COMPANY >

COLLECTIONS >

- 3D WALL
- CONCRETE & RESIN LOOK
- METAL LOOK
- MARBLE LOOK
- STONE LOOK
- WOOD LOOK

LARGE SIZES >

SLABS FOR COUNTERTOPS & FURNITURE >

SINKS & BATHROOM FURNISHING >

FACADES >

TECHNICAL SPECIFICATIONS >





# Exence

## Porcelain Tiles

### MATTE SURFACE



  $\pm 9$  mm  
**18,5x150 cm - 7 1/4" x 59"**  
 AO4H Exence Vanilla  
 AL87 Exence Almond  
 AL88 Exence Amber

  $\pm 9$  mm  
**20x120 cm - 7 7/8" x 47 1/4"**  
 AO47 Exence Vanilla  
 AO48 Exence Almond  
 AO49 Exence Amber



Matte Sensitech   $\pm 9$  mm



R10 B Matte Sensitech   $\pm 9$  mm



V2 Slight Variation



### MATTE SURFACE - SAW CUT



  $\pm 9$  mm  
**18,5x150 cm - 7 1/4" x 59"**  
 AOUN Exence Vanilla Saw Cut  
 AOUL Exence Almond Saw Cut  
 AOUM Exence Amber Saw Cut



INDEX



A COMPLETE PRODUCT SYSTEM >

PRODUCT FINDER >

SURFACE RANGE >

COMPANY >

COLLECTIONS >

3D WALL  
 CONCRETE & RESIN LOOK  
 METAL LOOK  
 MARBLE LOOK  
 STONE LOOK  
 WOOD LOOK

LARGE SIZES >

SLABS FOR COUNTERTOPS & FURNITURE >

SINKS & BATHROOM FURNISHING >

FACADES >

TECHNICAL SPECIFICATIONS >

# Exence

## Porcelain Tiles

### GRIP SURFACE



  
**± 9 mm**  
**18,5x150 cm - 7<sup>1</sup>/<sub>4</sub>"x59"**  
 AOUK Exence Vanilla Grip  
 AOUI Exence Almond Grip  
 AOIJ Exence Amber Grip

**H**  
 HEAVY TRAFFIC  
 Grip ± 9 mm  
 Outdoor ± 20 mm



**R11 C** Grip ± 9 mm  
**R11 C** Outdoor ± 20 mm



**V2** Slight Variation







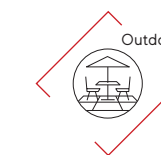

### OUTDOOR ± 20 mm



  
**± 20 mm**  
**30x120 cm - 11<sup>3</sup>/<sub>4</sub>"x47<sup>1</sup>/<sub>4</sub>"**  
 A2RY Exence Almond 20 mm  
 A2RZ Exence Amber 20 mm

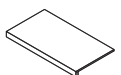
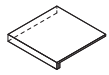

### TRIM TILES p. 352

	Battiscopa		Scalino *	Scalino Ang.*	Battiscopa Sag. Scala *		Elemento L *
							
	7,2x150 cm 2 <sup>7</sup> / <sub>8</sub> "x59"	6,5x120 cm 2 <sup>1</sup> / <sub>2</sub> "x47 <sup>1</sup> / <sub>4</sub> "	33x150 cm 13"x59"	33x33 cm 13"x13"	7,2x30 cm 2 <sup>7</sup> / <sub>8</sub> "x11 <sup>3</sup> / <sub>4</sub> "	7,2x30 cm 2 <sup>7</sup> / <sub>8</sub> "x11 <sup>3</sup> / <sub>4</sub> "	18,5x150 H. 4 cm 7 <sup>1</sup> / <sub>4</sub> "x59" H. 1 <sup>1</sup> / <sub>4</sub> "
	Matte	Matte	Matte	Matte	Matte	Matte	Grip
Vanilla	AOUX	AHAF	AOUY				
Almond	AMA2	AHAC	AMA6	DX AOUZ	SX AOUØ	DX AOU1	AOZI
Amber	AMA5	AHAD	AMA7	AMA8	AMBA	AMBE	AOZJ
				AMA9	AMBD	AMBF	AOZK
						SX AOU2	
						AMBG	
						AMBH	

\* These parts are supplied to order - I pezzi sono disponibili su ordinazione - Les pièces sont disponibles sur commande - Die Teile sind auf Bestellung lieferbar - Las piezas se hacen por encargo - Изготавливаются на заказ

INDEX



A COMPLETE  
PRODUCT  
SYSTEM >

PRODUCT  
FINDER >

SURFACE  
RANGE >

COMPANY >

COLLECTIONS >

3D WALL  
CONCRETE & RESIN LOOK  
METAL LOOK  
MARBLE LOOK  
STONE LOOK  
WOOD LOOK

LARGE SIZES >

SLABS FOR  
COUNTERTOPS  
& FURNITURE >

SINKS &  
BATHROOM  
FURNISHING >

FACADES >

TECHNICAL  
SPECIFICATIONS >

# Exence

## Porcelain Tiles

### DECOR RANGE



AOUU Exence  
Vanilla Square  
56,1x56,1 - 22"x22"



AOUV Exence  
Almond Square  
56,1x56,1 - 22"x22"



AOUW Exence  
Amber Square  
56,1x56,1 - 22"x22"



AOUR Exence  
Vanilla Tatami  
18,5x75 - 7 1/4"x29 1/2"



AOUS Exence  
Almond Tatami  
18,5x75 - 7 1/4"x29 1/2"



AOUT Exence  
Amber Tatami  
18,5x75 - 7 1/4"x29 1/2"



AOUG Exence  
Vanilla Chevron  
32,5x45 - 12 1/4"x17 1/4"



AMBJ Exence  
Almond Chevron  
32,5x45 - 12 1/4"x17 1/4"



AMBL Exence  
Amber Chevron  
32,5x45 - 12 1/4"x17 1/4"



© Ceramiche Atlas Concorde



© Ceramiche Atlas Concorde

INDEX



A COMPLETE  
PRODUCT  
SYSTEM



PRODUCT  
FINDER



SURFACE  
RANGE



COMPANY



COLLECTIONS



3D WALL  
CONCRETE & RESIN LOOK  
METAL LOOK  
MARBLE LOOK  
STONE LOOK  
WOOD LOOK

LARGE SIZES



SLABS FOR  
COUNTERTOPS  
& FURNITURE



SINKS &  
BATHROOM  
FURNISHING



FACADES



TECHNICAL  
SPECIFICATIONS



# Heartwood

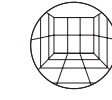

Floor & Wall

## Porcelain Tiles RECTIFIED MONOCALIBER

Sizes	Thickness	Surface finish
18,5x150 cm - 7 1/4"x59"	± 9 mm	Matte Sensitech R10 B
20x120 cm - 7 7/8"x47 1/4"	± 9 mm	Matte Sensitech R10 B

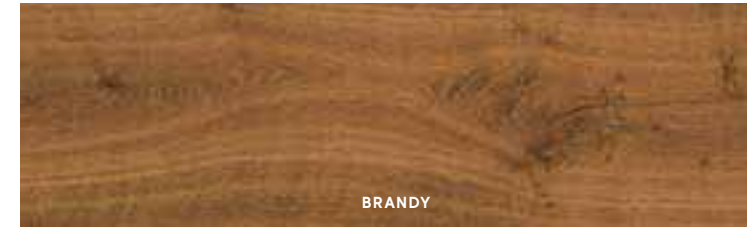

INDEX

A COMPLETE PRODUCT SYSTEM

PRODUCT FINDER

SURFACE RANGE

COMPANY

COLLECTIONS

- 3D WALL
- CONCRETE & RESIN LOOK
- METAL LOOK
- MARBLE LOOK
- STONE LOOK
- WOOD LOOK

LARGE SIZES

SLABS FOR COUNTERTOPS & FURNITURE

SINKS & BATHROOM FURNISHING

FACADES

TECHNICAL SPECIFICATIONS

# Heartwood

## Porcelain Tiles

### MATTE SURFACE



**± 9 mm** (S)  
**18,5x150 cm - 7 1/4"x59"**  
 AL68 Heartwood Malt  
 AL84 Heartwood Brandy  
 AL69 Heartwood Moka

**± 9 mm** (S)  
**20x120 cm - 7 7/8"x47 1/4"**  
 AL7E Heartwood Malt  
 AL85 Heartwood Brandy  
 AL7F Heartwood Moka

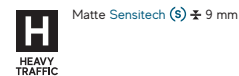

### DECOR RANGE



AOYG Heartwood Malt  
Mansion Weave  
34,6x40 - 13 5/8"x15 1/4"



AOYH Heartwood Brandy  
Mansion Weave  
34,6x40 - 13 5/8"x15 1/4"



AOYJ Heartwood Moka  
Mansion Weave  
34,6x40 - 13 5/8"x15 1/4"



AO3K Heartwood Malt  
Marble Chevron  
29,4x28,7 - 11 5/8"x11 1/8"  
Malt + Marvel Black Atlantis



AO3L Heartwood Brandy  
Marble Chevron  
29,4x28,7 - 11 5/8"x11 1/8"  
Brandy + Marvel Black Atlantis



AOYI Heartwood Moka  
Marble Chevron  
29,4x28,7 - 11 5/8"x11 1/8"  
Moka + Marvel Black Atlantis



AOYD Heartwood Malt Tatami  
18,5x75 - 7 1/4"x29 1/2"



AOYE Heartwood Brandy Tatami  
18,5x75 - 7 1/4"x29 1/2"



AOYF Heartwood Moka Tatami  
18,5x75 - 7 1/4"x29 1/2"

### TRIM TILES p. 352

	Battiscopa		Scalino *	Scalino Ang.*	Battiscopa Sag. Scala *	
	7,2x150 cm 2 7/8"x59"	6,5x120 cm 2 1/2"x47 1/4"	33x150 cm 13"x59"	33x33 cm 13"x13"	7,2x30 cm 2 7/8"x11 1/4"	7,2x30 cm 2 7/8"x11 1/4"
	Matte	Matte	Matte	Matte	Matte	Matte
Malt	AMAH	AHAI	AMAK	DX AMAN	SX AMAR	SX AMAZ
Brandy	AMAI	AHAH	AMAL	AMAO	AMAU	AMAØ
Moka	AMAJ	AHAJ	AMAM	AMAQ	AMAV	AMA1

\* These parts are supplied to order - I pezzi sono disponibili su ordinazione - Les pièces sont disponibles sur commande - Die Teile sind auf Bestellung lieferbar - Las piezas se hacen por encargo - Изготавливаются на заказ

# Nid



© Ceramiche Atlas Concorde



© Ceramiche Atlas Concorde



© Ceramiche Atlas Concorde

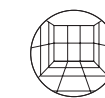

Floor & Wall

## Porcelain Tiles RECTIFIED MONOCALIBER

Sizes	Thickness	Surface finish
25x150 cm - 9 <sup>7</sup> / <sub>8</sub> "x59"	± 9 mm	Matte R10 A
18,5x150 cm - 7 <sup>1</sup> / <sub>4</sub> "x59"	± 9 mm	Matte R10 A
15x90 cm - 5 <sup>7</sup> / <sub>8</sub> "x35 <sup>5</sup> / <sub>8</sub> "	± 9 mm	Matte R10 A

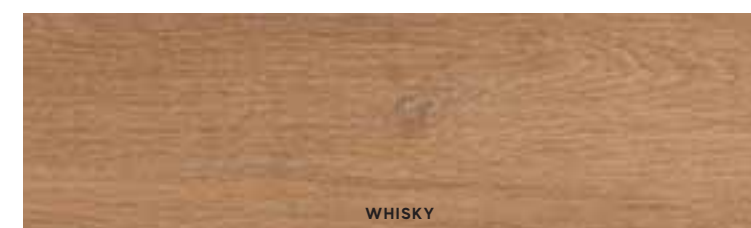
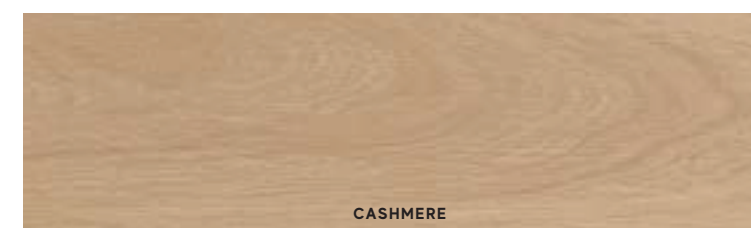

INDEX



A COMPLETE PRODUCT SYSTEM



PRODUCT FINDER



SURFACE RANGE



COMPANY



COLLECTIONS



- 3D WALL
- CONCRETE & RESIN LOOK
- METAL LOOK
- MARBLE LOOK
- STONE LOOK
- WOOD LOOK

LARGE SIZES



SLABS FOR COUNTERTOPS & FURNITURE



SINKS & BATHROOM FURNISHING



FACADES



TECHNICAL SPECIFICATIONS



# Nid

## Porcelain Tiles

### MATTE SURFACE

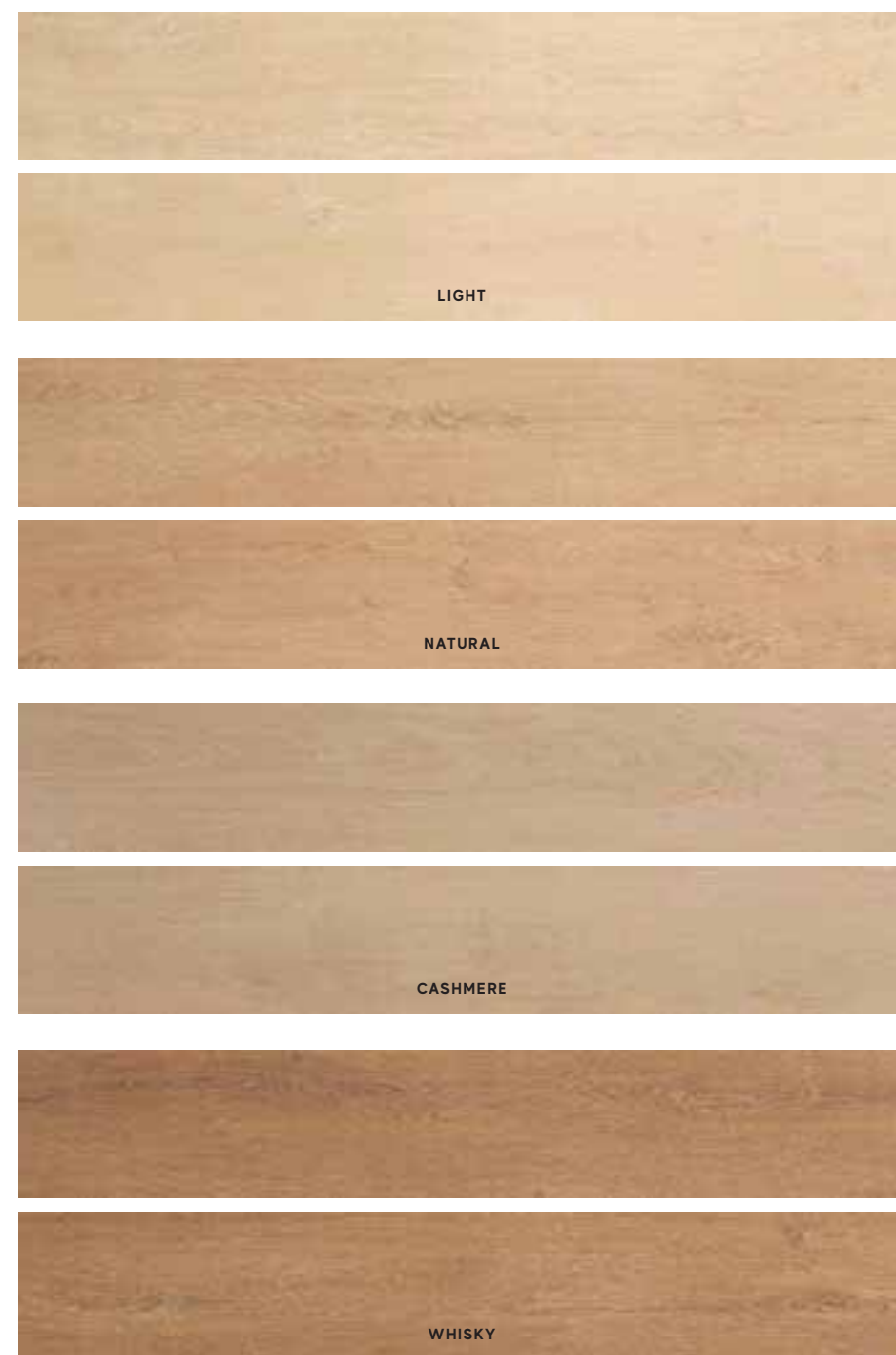

± 9 mm  
**25x150 cm** - 9<sup>7</sup>/<sub>8</sub>"x59"  
 AAL5 Nid Light  
 AAL6 Nid Natural  
 AKSU Nid Cashmere  
 AAL7 Nid Whisky



### MATTE SURFACE

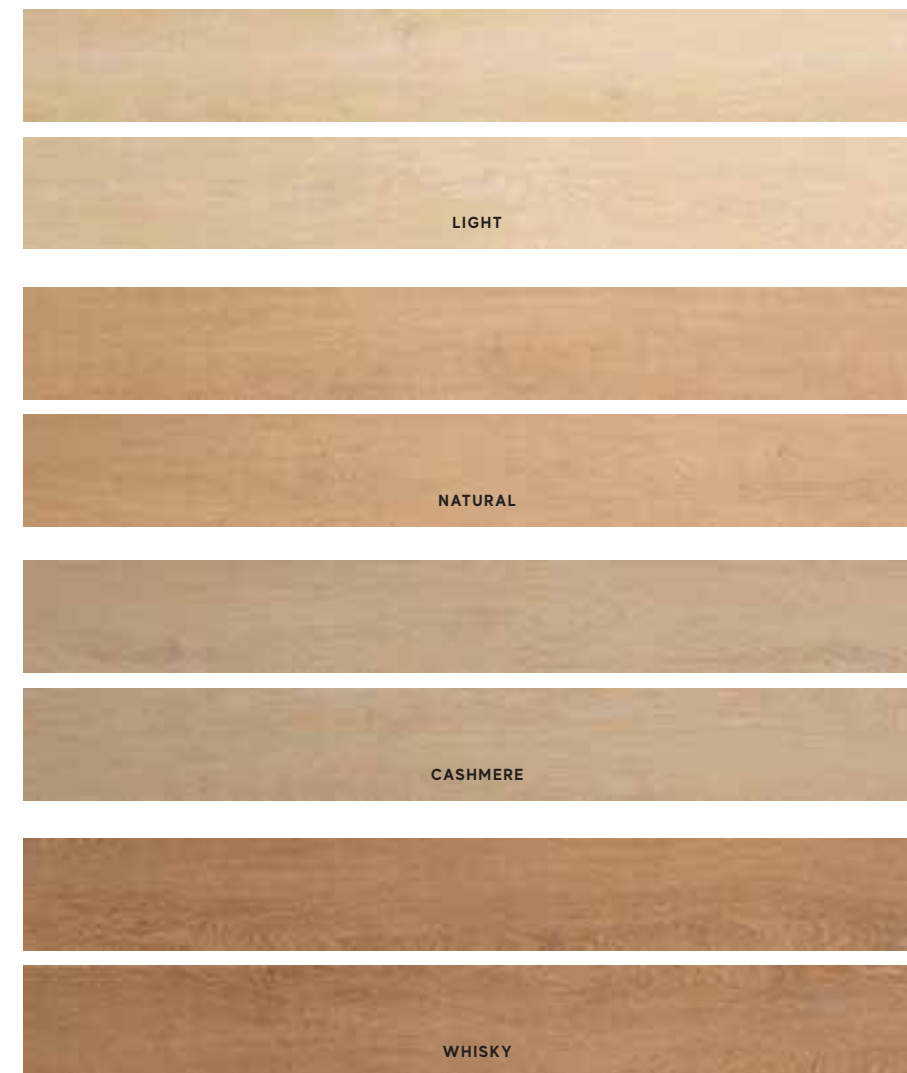





± 9 mm  
**18,5x150 cm** - 7<sup>1</sup>/<sub>8</sub>"x59"  
 AANK Nid Light  
 AANJ Nid Natural  
 AANI Nid Cashmere  
 AANL Nid Whisky

± 9 mm  
**15x90 cm** - 5<sup>7</sup>/<sub>8</sub>"x35<sup>3</sup>/<sub>8</sub>"  
 D23Ø Nid Light  
 D231 Nid Natural  
 D233 Nid Cashmere  
 D232 Nid Whisky

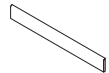

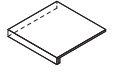
#### TRIM TILES p. 352

	Battiscopa	Scalino *	Scalino Ang.*	Battiscopa Sag. Scala *
				
	7,2x90 cm 2 <sup>7</sup> / <sub>8</sub> "x35 <sup>3</sup> / <sub>8</sub> " Matte	33x150 cm 13"x59" Matte	33x33 cm 13"x13" Matte	7,2x30 cm 2 <sup>7</sup> / <sub>8</sub> "x11 <sup>1</sup> / <sub>4</sub> " Matte
Light	A8KF	A8KJ	DX A8KN	SX A8KR
Natural	A8KG	A8KK	A8KO	A8KS
Cashmere	A8KI	A8KM	A8KQ	A8KU
Whisky	A8KH	A8KL	A8KP	A8KT
				DX A8KV
				A8KW
				A8KY
				A8KX
				SX A8KZ
				A8KØ
				A8K2
				A8K1

\* These parts are supplied to order - I pezzi sono disponibili su ordinazione - Les pièces sont disponibles sur commande - Die Teile sind auf Bestellung lieferbar - Las piezas se hacen por encargo - Изготавливаются на заказ

INDEX



A COMPLETE  
PRODUCT  
SYSTEM



PRODUCT  
FINDER



SURFACE  
RANGE



COMPANY



COLLECTIONS



3D WALL  
CONCRETE & RESIN LOOK  
METAL LOOK  
MARBLE LOOK  
STONE LOOK  
WOOD LOOK

LARGE SIZES



SLABS FOR  
COUNTERTOPS  
& FURNITURE



SINKS &  
BATHROOM  
FURNISHING



FACADES



TECHNICAL  
SPECIFICATIONS



# Nid

## Porcelain Tiles

### DECOR RANGE



AAOA Nid Light  
Mosaico Esagono  
30x35 - 11<sup>1</sup>/<sub>4</sub>"x13<sup>3</sup>/<sub>4</sub>"



AAOD Nid Cashmere  
Mosaico Esagono  
30x35 - 11<sup>1</sup>/<sub>4</sub>"x13<sup>3</sup>/<sub>4</sub>"



AAOB Nid Natural  
Mosaico Esagono  
30x35 - 11<sup>1</sup>/<sub>4</sub>"x13<sup>3</sup>/<sub>4</sub>"



AAOC Nid Whisky  
Mosaico Esagono  
30x35 - 11<sup>1</sup>/<sub>4</sub>"x13<sup>3</sup>/<sub>4</sub>"

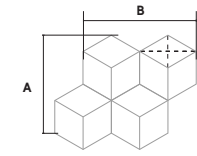

**A** 30 cm - 11<sup>1</sup>/<sub>4</sub>"  
**B** 35 cm - 13<sup>3</sup>/<sub>4</sub>"  
10x17 cm - 3<sup>7</sup>/<sub>8</sub>"x6<sup>1</sup>/<sub>4</sub>"



AAN6 Nid Light  
Herringbone  
36,2x41,2 - 14<sup>1</sup>/<sub>8</sub>"x16<sup>1</sup>/<sub>8</sub>"



AAN9 Nid Cashmere  
Herringbone  
36,2x41,2 - 14<sup>1</sup>/<sub>8</sub>"x16<sup>1</sup>/<sub>8</sub>"



AAN7 Nid Natural  
Herringbone  
36,2x41,2 - 14<sup>1</sup>/<sub>8</sub>"x16<sup>1</sup>/<sub>8</sub>"



AAN8 Nid Whisky  
Herringbone  
36,2x41,2 - 14<sup>1</sup>/<sub>8</sub>"x16<sup>1</sup>/<sub>8</sub>"

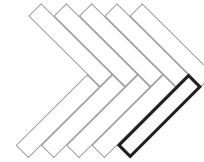

4,9x29 cm - 1<sup>7</sup>/<sub>8</sub>"x11<sup>1</sup>/<sub>8</sub>"



AAOO Nid Light  
Mosaico Intreccio  
35x35 - 13<sup>3</sup>/<sub>4</sub>"x13<sup>3</sup>/<sub>4</sub>"



AAOR Nid Cashmere  
Mosaico Intreccio  
35x35 - 13<sup>3</sup>/<sub>4</sub>"x13<sup>3</sup>/<sub>4</sub>"



AAOP Nid Natural  
Mosaico Intreccio  
35x35 - 13<sup>3</sup>/<sub>4</sub>"x13<sup>3</sup>/<sub>4</sub>"



AAOQ Nid Whisky  
Mosaico Intreccio  
35x35 - 13<sup>3</sup>/<sub>4</sub>"x13<sup>3</sup>/<sub>4</sub>"

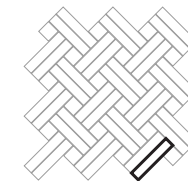

2,3x11,5 cm - 7<sup>7</sup>/<sub>8</sub>"x4<sup>1</sup>/<sub>2</sub>"



AANX Nid Light  
Tatami  
22,5x90 - 8<sup>7</sup>/<sub>8</sub>"x35<sup>3</sup>/<sub>8</sub>"



AAN1 Nid Cashmere  
Tatami  
22,5x90 - 8<sup>7</sup>/<sub>8</sub>"x35<sup>3</sup>/<sub>8</sub>"



AANY Nid Natural  
Tatami  
22,5x90 - 8<sup>7</sup>/<sub>8</sub>"x35<sup>3</sup>/<sub>8</sub>"



AANØ Nid Whisky  
Tatami  
22,5x90 - 8<sup>7</sup>/<sub>8</sub>"x35<sup>3</sup>/<sub>8</sub>"

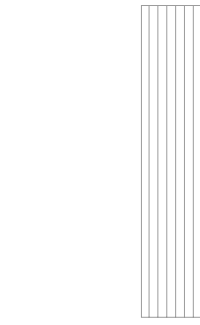

2,3x90 cm - 7<sup>7</sup>/<sub>8</sub>"x35<sup>3</sup>/<sub>8</sub>"



AAN2 Nid Light  
Chevron  
11,5x67 - 4<sup>1</sup>/<sub>2</sub>"x26<sup>3</sup>/<sub>8</sub>"



AAN3 Nid Natural  
Chevron  
11,5x67 - 4<sup>1</sup>/<sub>2</sub>"x26<sup>3</sup>/<sub>8</sub>"



AAN5 Nid Cashmere  
Chevron  
11,5x67 - 4<sup>1</sup>/<sub>2</sub>"x26<sup>3</sup>/<sub>8</sub>"



AAN4 Nid Whisky  
Chevron  
11,5x67 - 4<sup>1</sup>/<sub>2</sub>"x26<sup>3</sup>/<sub>8</sub>"

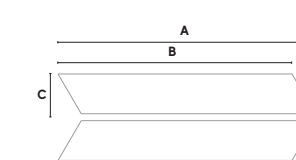

**A** 11,5 cm - 4<sup>1</sup>/<sub>2</sub>"  
**B** 73,6 cm - 29"  
**C** 67 cm - 26<sup>3</sup>/<sub>8</sub>"

INDEX



A COMPLETE  
PRODUCT  
SYSTEM



PRODUCT  
FINDER



SURFACE  
RANGE



COMPANY



COLLECTIONS



3D WALL  
CONCRETE & RESIN LOOK  
METAL LOOK  
MARBLE LOOK  
STONE LOOK  
WOOD LOOK

LARGE SIZES



SLABS FOR  
COUNTERTOPS  
& FURNITURE



SINKS &  
BATHROOM  
FURNISHING



FACADES



TECHNICAL  
SPECIFICATIONS





# Destinations of use



**HEAVY TRAFFIC**

## HEAVY COMMERCIAL

Malls, airports, places of worship, schools, museums, squares, hospitals, hotels – foyers, undergrounds, train stations, etc.

## COMMERCIALI PESANTI

Mall, aeroporti, luoghi di culto, scuole, musei, piazze, ospedali, hotel – hall di ingresso, metropolitane, stazioni ferroviarie, ecc...

## COMMERCIAL LOURD

Centres commerciaux, aéroports, lieux de culte, écoles, musées, places, hôpitaux, hôtels – halls d'entrée, stations de métro, gares, etc...

## STARK BEANSPRUCHE GEWERBEBEREICHE

Enkaufszentren, Flughäfen, Kulturstätten, Schulen, Museen, Plätze, Krankenhäuser, Hotels – Eingangshallen, U-Bahn-Stationen, Bahnhöfe etc.

## COMERCIALES PESADOS

Centros comerciales, aeropuertos, lugares de culto, colegios, museos, plazas, hospitales, hoteles – hall de entrada, metros, estaciones de trenes, etc. ...

## ОБЩЕСТВЕННЫЕ ОБЪЕКТЫ С ВЫСОКОЙ ПОСЕЩАЕМОСТЬЮ

Торговые центры, аэропорты, церкви, школы, музеи, площади, больницы, входные холлы отелей, метро, вокзалы и т.п.



**MEDIUM TRAFFIC\***

## MEDIUM COMMERCIAL\*

Restaurants, offices, shops, public restrooms, public offices, hotels except for foyers, business lounges, etc. with the exception of mandatory passageways and areas subject to the transit of trolleys with hard wheels or highly concentrated loads.

## COMMERCIALI MEDI\*

Ristoranti, uffici, negozi, bagni pubblici, uffici pubblici, hotel – ad esclusione delle hall di ingresso, business lounge, etc. a esclusione di passaggi obbligati e zone soggetto a transito di carrelli con ruote dure ovvero elevati carichi concentrati.

## BÂTIMENT COMMERCIAL MOYEN\*

Restaurants, bureaux, boutiques, sanitaires publics, bureaux publics, hôtels – à l'except-tion des halls d'entrée, business lounges, etc..., ainsi que des points de passage obligés et des zones soumises au passage de chariots à roues dures ou de charges ponctuel-les lourdes.

## GEWERBEBEREICHE MIT MITTLERER BEANSPRUCHUNG\*

Restaurants, Büros, Geschäfte, öffentliche Toiletten, öffentliche Ämter, Hotels mit Ausnahme der Eingangshallen, Business Lounges etc., unter Ausschluss obligatorischer Passagen sowie mit harten Rädern befahrener bzw. hohen, konzentrierten Lasten ausgesetzter Bereiche.

## COMERCIALES MEDIOS\*

Restaurants, oficinas, tiendas, baños públicos, oficinas públicas, hoteles – excluidos los pasillos de entradas, salas de negocios, etc. excluidos los pasos obligatorios y áreas sujetas al tránsito de carretillas con ruedas duras o cargas altamente concentradas.

## ОБЩЕСТВЕННЫЕ ОБЪЕКТЫ СО СРЕДНЕЙ ПОСЕЩАЕМОСТЬЮ\*

Рестораны, офисы, магазины, общественные туалеты, общественные учреждения, отели (кроме входных холлов), бизнес-залы и т.п., за исключением общих проходов и мест, где предвидятся сосредоточенные нагрузки или перемещение тележек на жестких колесах.



**LIGHT TRAFFIC**

## RESIDENTIAL

Bedrooms, living rooms, studies, private kitchens, private bathrooms, etc.

## RESIDENZIALI

Camere da letto, soggiorni, studi, cucine private, bagni privati...

## BÂTIMENT D'HABITATION

Chambres de nuit, salons, pièces à usage professionnel, cuisines, salles de bains.

## WOHNUNGSBAU

Schlafzimmer, Wohnzimmer, Arbeitszimmer, private Küchen und Bäder...

## RESIDENCIALES

Dormitorios, salones, salas de estar, cocinas particulares, cuartos de baño particulares...

## ЖИЛЫЕ ПОМЕЩЕНИЯ

Спальни, гостиные, рабочие кабинеты, домашние кухни, домашние ванные комнаты и т.п.

# Color-Shading



**V1**

**Uniform appearance**  
Aspetto uniforme  
Aspect uniforme  
Gleichmäßiges Erscheinungsbild  
Aspecto uniforme  
Однородный вид



**V2**

**Slight variation**  
Variazione minima  
Variation minimale  
Leichte Abweichung  
Variación mínima  
Минимальная Неоднородность



**V3**

**Moderate variation**  
Variazione moderata  
Variation Modérée  
Mäßige Abweichung  
Variación moderada  
Умеренная Неоднородность



**V4**

**Substantial variation**  
Variazione sostanziale  
Variation substantielle  
Grundlegende Abweichung  
Variación sustancial  
Значительная Неоднородность

The V-Shade classification indicates the colour shading level of a product, that is to say the chromatic and/or surface variation among tiles of the same collection.

La classificazione VShade indica il livello di stonalizzazione del prodotto, ovvero di variazione cromatica e/o superficiale che intercorre tra le piastrelle di una stessa collezione.

La classification VShade indique le niveau de gradation du produit,c'est-à-dire de variation chromatique et/ou superficielle entre des dalles d'une même collection.

Die Klassifizierung V-Shade gibt das Niveau des Farbverlaufs des Produktes oder die Abweichung des Farbtons und/oder Oberfläche unter den Fliesen der gleichen Kollektion an.

La clasificación V-Shade indica el nivel de variación de tono del producto, o de variación cromática y/o superficial que existe entre las baldosas de una misma colección.

Классификация V-Shade указывает на уровень цветовой или фактурной неоднородности плиток, т.е. на отличия по цвету или по фактуре между плитками одной коллекции.

Serie / Series Série / Serie Serie / Серия	Colore / Colour Couleur / Farbe Color / Цвет	Stonalizzazione / Colour-shading Denuancement / Marmorierung Contraste / Цветовое отличие
<b>3D WALL</b>	Wall tiles	<b>V1</b>
<b>3D WALL CARVE</b>	Wall tiles	<b>V1</b>
<b>AIX</b>	Porcelain & Wall tiles	<b>V3 Porcelain tiles</b> <b>V2 Wall tiles</b>
<b>APLOMB</b>	Wall tiles	<b>V1</b>
<b>ARTY</b>	Wall tiles	<b>V1</b>
<b>AXI</b>	Porcelain tiles	White Pine <b>V2</b> Silver Fir <b>V2</b> Grey Timber <b>V2</b> Dark Oak <b>V2</b> Golden Oak <b>V3</b> Brown Chestnut <b>V3</b>
<b>BLAZE</b>	Porcelain & Wall tiles	<b>V3</b>
<b>BOOST</b>	Porcelain & Wall tiles	<b>V3 Porcelain tiles</b> <b>V2 Wall tiles</b>
<b>BOOST NATURAL</b>	Porcelain & Wall tiles	<b>V2 Porcelain tiles</b> <b>V2 Wall tiles</b>
<b>BOOST MIX</b>	Porcelain tiles	<b>V3</b>
<b>BOOST PRO</b>	Porcelain & Wall tiles	<b>V3 Porcelain tiles</b> <b>V2 Wall tiles</b>
<b>BOOST STONE</b>	Porcelain tiles	<b>V2</b>
<b>BRAVE</b>	Porcelain & Wall tiles	<b>V2</b>
<b>DWELL</b>	Porcelain tiles	<b>V2</b>
<b>ENTICE</b>	Porcelain tiles	<b>V2</b>
<b>ETIC</b>	Porcelain tiles	Noce <b>V3</b> Palissandro <b>V3</b> Rovere <b>V3</b> Rovere Bianco <b>V2</b> Rovere Grigio <b>V3</b>
<b>ETIC PRO</b>	Porcelain tiles	<b>V3</b>
<b>EXENCE</b>	Porcelain tiles	<b>V2</b>
<b>HEARTWOOD</b>	Porcelain tiles	<b>V3</b>
<b>KLIF</b>	PorcelainPorcelain tile	<b>V3</b>
<b>KONE</b>	Porcelain tiles	<b>V2</b>
<b>LIMS</b>	Porcelain & Wall tiles	<b>V3 Porcelain tiles</b> <b>V2 Wall tiles</b>

Serie / Series Série / Serie Serie / Серия	Colore / Colour Couleur / Farbe Color / Цвет	Stonalizzazione / Colour-shading Denuancement / Marmorierung Contraste / Цветовое отличие
<b>MARVEL</b>	Porcelain & Wall tiles	<b>V2</b>
<b>MARVEL DREAM</b>	Porcelain & Wall tiles	Brazil Green <b>V3</b> Ultramarine <b>V3</b> Bianco Fantastico <b>V2</b> Morning Sky <b>V3</b> Grigio Intenso <b>V2</b> Black Atlantis <b>V2</b>
<b>MARVEL EDGE</b>	Porcelain & Wall tiles	Royal Calacatta <b>V3</b> Imperial White <b>V2</b> Elegant Sable <b>V2</b> Gris Supreme <b>V2</b> Absolute Brown <b>V3</b> Gold Onyx <b>V3</b> Agata Azul <b>V3</b> Red Luxury <b>V3</b>
<b>MARVEL GALA</b>	Porcelain tiles	<b>V3</b>
<b>MARVEL GEMS</b>	Porcelain tiles	<b>V2</b>
<b>MARVEL PRO</b>	Porcelain & Wall tiles	Statuario Select <b>V3</b> Grey Fleury <b>V3</b> Noir St. Laurent <b>V2</b> Crema Delicata <b>V2</b> Travertino Alabastrino <b>V2</b> Travertino Silver <b>V2</b> Calacatta Delicata <b>V2</b>
<b>MARVEL SHINE</b>	Porcelain & Wall tiles	Calacatta Prestigio <b>V2</b> Statuario Supremo <b>V2</b> Calacatta Imperiale <b>V3</b>
<b>MARVEL STONE</b>	Porcelain & Wall tiles	<b>V2</b>
<b>MARVEL TRAVERTINE</b>	Porcelain tiles	<b>V3</b>
<b>MARVEL X</b>	Porcelain tiles	Calacatta Apuano <b>V2</b> Calacatta Sublime <b>V3</b> Calacatta Perla <b>V2</b> Grey Cloud <b>V2</b> Fior di Bosco <b>V3</b>
<b>NID</b>	Porcelain tiles	<b>V2</b>
<b>NORDE</b>	Porcelain tiles	<b>V3</b>
<b>PRISM</b>	Porcelain & Wall tiles	<b>V2</b>
<b>TRUST</b>	Porcelain tiles	<b>V3</b>
<b>VENTI BOOST</b>	Porcelain tiles	Classic Carpet 1, 2, 3 <b>V2</b> Blue Carpet 1, 2, 3 <b>V2</b> Carpet 1, 2, 3 Warm <b>V2</b> Carpet 1, 2, 3 Cold <b>V2</b> Classic Mix, Blue Mix <b>V4</b> Mix Warm, Mix Cold <b>V4</b>

\* Polished and silk finishes are recommended for low-stress residential or commercial floors where anti-slip performance is not required. The surface's shine and superior ease of cleaning are the result of in-depth studies and extensive technical research aimed at ensuring its durability over time. If the product is in direct contact with the outside, use moisture and dirt absorption devices to prevent scratches. Under no circumstances does Atlas Concorde accept responsibility for any use of the product other than as recommended above. - Le finiture lappata e silk sono indicate per pavimenti residenziali o commerciali poco sollecitati, laddove non siano richieste prestazioni antiscivolo. La lucentezza e l'elevata facilità di pulizia della superficie sono frutto di studi approfonditi e accurate ricerche tecniche volte a garantirne la persistenza nel tempo. Se il prodotto è a diretto contatto con l'esterno, prevedere dei dispositivi di assorbimento dell'umidità e dello sporco per prevenire la formazione di graffi. Atlas Concorde non si assume in nessun caso la responsabilità per un uso del prodotto diverso da quanto consigliato sopra. - Les finitions rodée et soyeuse conviennent aux sols résidentiels ou commerciaux à faibles contraintes, où la performance antidérapante n'est pas requise. La brillance et la grande facilité de nettoyage de la surface sont le résultat d'études approfondies et de recherches techniques précises visant à assurer sa persistance dans le temps. Si le produit est en contact direct avec l'extérieur, prévoyez des dispositifs d'absorption de l'humidité et de la saleté pour éviter la formation de rayures. Atlas Concorde n'accepte aucune responsabilité pour toute utilisation du produit autre que celle recommandée ci-dessus. - Die Oberflächenversionen Geläpft und Silk eignen sich für Bodenbeläge in Wohnbereichen bzw. in gering beanspruchten Gewerberäumen, wenn keine Rutschfestigkeit erforderlich ist. Der Glanz und die einfache Reinigung der Oberfläche sind das Resultat eingehender technischer Studien, mit denen die langfristige Beständigkeit sichergestellt wurde. Kommt das Produkt direkt mit der externen Umgebung in Kontakt, so sind Feuchtigkeit und Schmutz mit geeigneten Mitteln aufzunehmen, um Kratzer zu vermeiden. Atlas Concorde haltet keinesfalls für eine nicht den vorstehenden Empfehlungen entsprechende Verwendung des Produkts. - Los acabados lapados y silk son adecuados para pavimentos residenciales y comerciales con poco tráfico, donde no se requiere un efecto antideslizante. El brillo y la gran facilidad de limpieza de la superficie son el resultado de profundos estudios e investigaciones técnicas precisas para asegurar su persistencia en el tiempo. Si el producto está en contacto directo con el exterior, proporcionar dispositivos de absorción de humedad y suciedad para evitar arañazos. Atlas Concorde no asume responsabilidad alguna por cualquier uso del producto distinto del recomendado anteriormente. - Лаппированная поверхность и поверхность Silk рекомендованы для полов жилых и коммерческих помещений с невысокой интенсивностью эксплуатации, в которых от покрытий не требуется характеристик сопротивления скольжению. Блеск и легкая очищаемость являются результатом глубоких исследований, направленных на создание долговечного материала. Если плитка находится в непосредственном контакте с наружной средой, необходимо предусмотреть устройства поглощения влаги и грязи во избежание образования царапин. Atlas Concorde не несет ответственности за использование изделий с нарушением вышеприведенных рекомендаций.

# Trim tiles

## TRIM TILES ± 9 mm - ± 9,5 mm

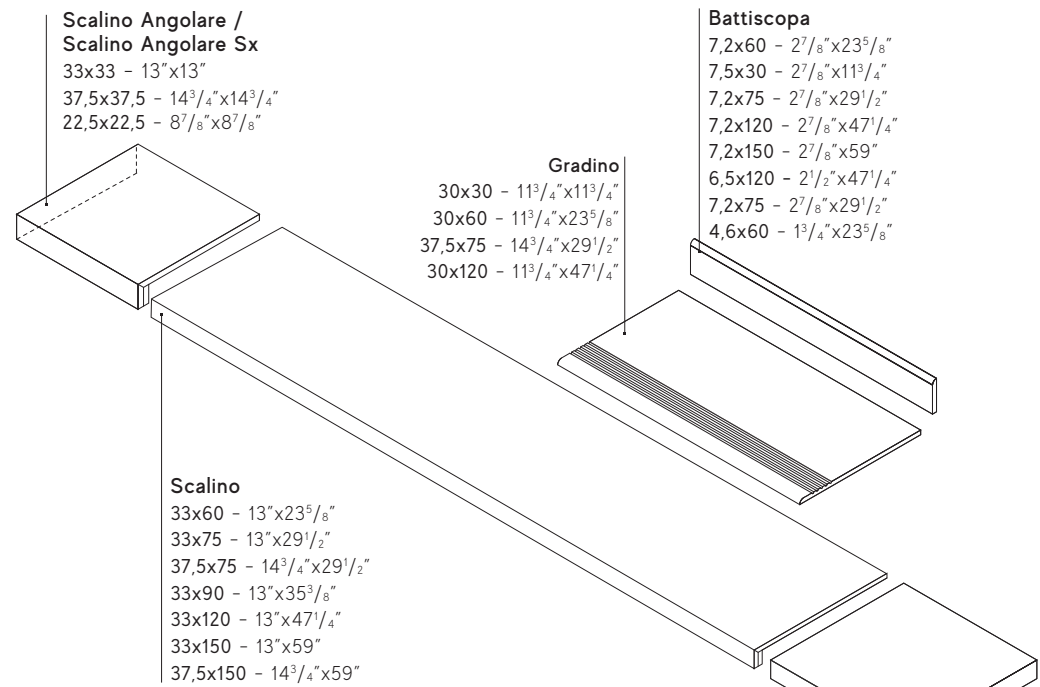

### Battiscopa Sagomato

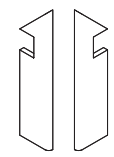

**Battiscopa Sag. Scala Dx / Sx**  
 7,5x30 - 3"x11<sup>3</sup>/<sub>4</sub>"  
 7,2x30 - 2<sup>7</sup>/<sub>8</sub>"x11<sup>3</sup>/<sub>4</sub>"

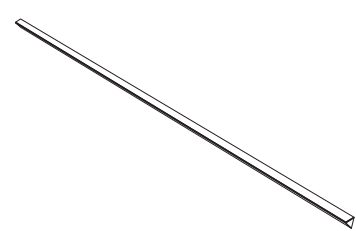

**Corner ± 6 mm**  
 1x120 cm - 3<sup>7</sup>/<sub>8</sub>"x47<sup>1</sup>/<sub>4</sub>"

**Corner ± 6 mm A.E.**  
 1x1 cm - 3<sup>7</sup>/<sub>8</sub>"x3<sup>7</sup>/<sub>8</sub>"

**Scalino Angolare / Scalino Angolare Dx**  
 33x33 - 13"x13"  
 37,5x37,5 - 14<sup>3</sup>/<sub>8</sub>"x14<sup>3</sup>/<sub>8</sub>"  
 22,5x22,5 - 8<sup>7</sup>/<sub>8</sub>"x8<sup>7</sup>/<sub>8</sub>"

## TRIM TILES TECHNICAL DRAWS

### Gradino

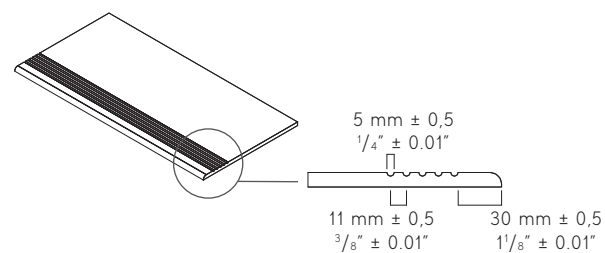

### Scalino

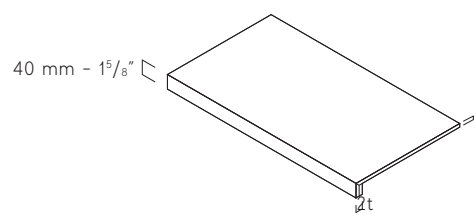

### Elemento I Strutturato/grip

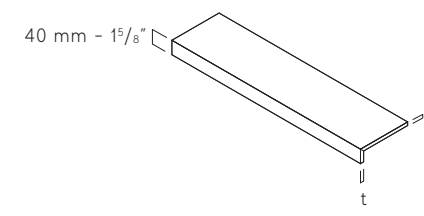

### Battiscopa sagomato

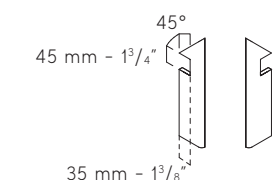

### Scalino angolare

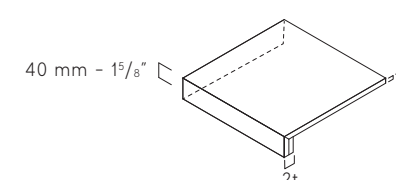

t = thickness

## OUTDOOR TRIM TILES ± 9 mm

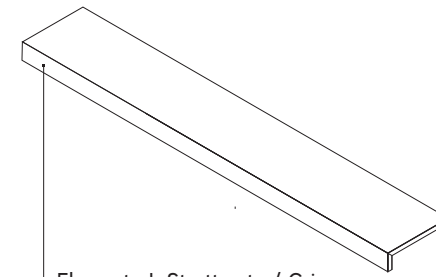

**Elemento L Strutturato / Grip**  
 18,5x150 H. 4 - 7<sup>1</sup>/<sub>4</sub>"x59" H. 1<sup>5</sup>/<sub>8</sub>"  
 20x120 H. 4 - 7<sup>1</sup>/<sub>8</sub>"x47<sup>1</sup>/<sub>4</sub>" H. 1<sup>5</sup>/<sub>8</sub>"  
 22,5x90 H. 4 - 8<sup>7</sup>/<sub>8</sub>"x35<sup>3</sup>/<sub>8</sub>" H. 1<sup>5</sup>/<sub>8</sub>"  
 15x75 H. 4 - 5<sup>7</sup>/<sub>8</sub>"x29<sup>1</sup>/<sub>2</sub>" H. 1<sup>5</sup>/<sub>8</sub>"  
 15x60 H. 4 - 5<sup>7</sup>/<sub>8</sub>"x23<sup>5</sup>/<sub>8</sub>" H. 1<sup>5</sup>/<sub>8</sub>"

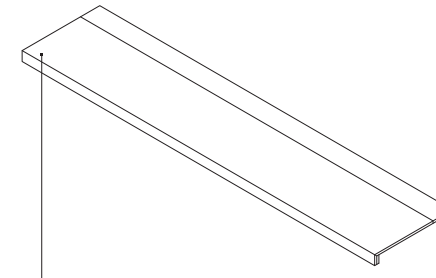

**Wood Look 33x120**  
**Elemento L Strutturato /Grip**  
 33x120 H.4 - 13"x47<sup>1</sup>/<sub>4</sub>" H. 1<sup>5</sup>/<sub>8</sub>"

## OUTDOOR TRIM TILES ± 20 mm

### Lineare

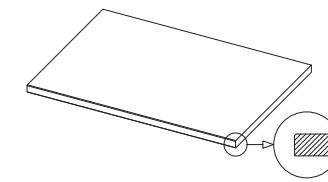

### Round <sup>(1)</sup>

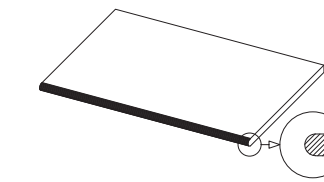

### Round 60 <sup>(1)</sup>

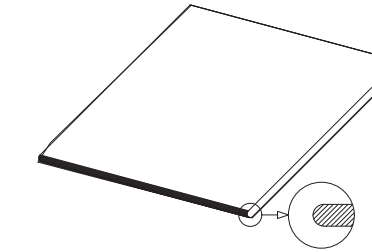

### Gradino round 60 <sup>(1)</sup>

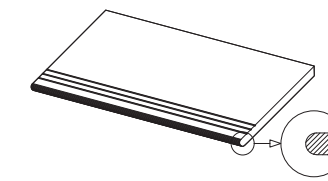

### Elemento L <sup>(1)</sup>

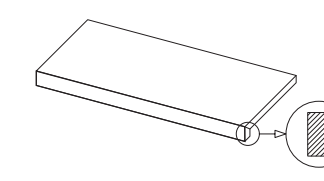

### Alzata

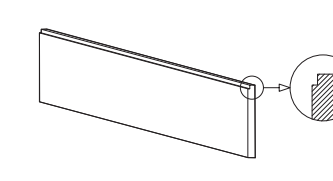

### Top

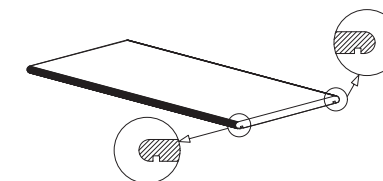

### Costa Design

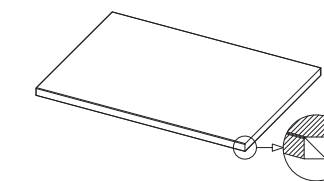

### Bordo Piscina <sup>(1)</sup>

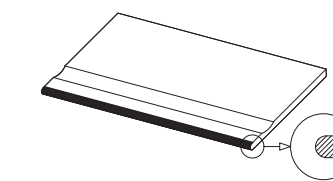

### Griglia <sup>(1)</sup>

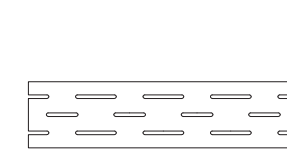

### Curve

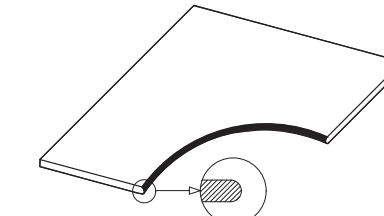

### Smussato

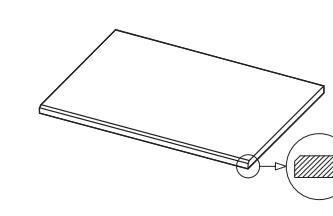

<sup>(1)</sup> Right/left angular elements are available - Sono disponibili gli elementi angolari dx/sx

## STEPS

### Round + Alzata

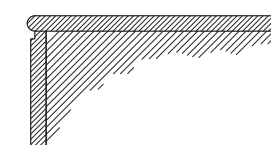

### Lineare + Alzata

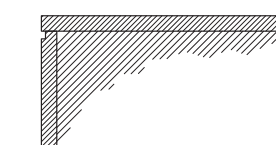

### Elemento L + Alzata

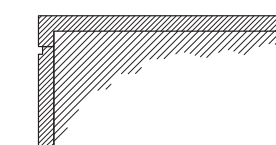

INDEX



A COMPLETE PRODUCT SYSTEM



PRODUCT FINDER



SURFACE RANGE



COMPANY



COLLECTIONS



3D WALL  
 CONCRETE & RESIN LOOK  
 METAL LOOK  
 MARBLE LOOK  
 STONE LOOK  
 WOOD LOOK

LARGE SIZES



SLABS FOR COUNTERTOPS & FURNITURE



SINKS & BATHROOM FURNISHING



FACADES



TECHNICAL SPECIFICATIONS



# Trim tiles, 20 mm

	Lineare	Round										Round 60 Angolare	Gradiato Round	Elemento L Angolare	Alzata	Top	Costa Design	Bordo Piscina Angolare Dx/Sx	Griglia	Curve	Smussato				
	30x60 cm 11 7/8 x 23 3/8"	40x80 cm 15 7/8 x 31 1/2"	45x90 cm 17 1/2 x 35 3/8"	60x90 cm 23 5/8 x 35 3/8"	30x120 cm 11 7/8 x 47 1/4"	33x120 cm 13 x 47 1/4"	30x60 cm 11 7/8 x 23 3/8"	33x120 cm 13 x 47 1/4"	40x80 cm 15 7/8 x 31 1/2"	45x90 cm 17 1/2 x 35 3/8"	60x90 cm 23 5/8 x 35 3/8"	30x120 cm 11 7/8 x 47 1/4"	30x60 cm 11 7/8 x 23 3/8"	20x90 cm 7 7/8 x 35 3/8"	30x120 cm 11 7/8 x 47 1/4"	20x120 cm 7 7/8 x 47 1/4"	30x120 cm 11 7/8 x 47 1/4"	30x60 cm 11 7/8 x 23 3/8"	30x60 cm 11 7/8 x 23 3/8"	15x60 cm 5 7/8 x 23 3/8"	20x60 cm 7 7/8 x 23 3/8"	60x60 cm 23 5/8 x 23 5/8"	30x60 cm 11 7/8 x 23 3/8"		
		DX	SX	DX	SX	DX	SX	DX	SX	DX	SX	DX	SX	DX	SX	DX	SX	DX	SX	DX	SX	DX	SX	DX	SX
AIX																									
BLAZE	•	•	•	•	•	•	•	•	•	•	•	•	•	•	•	•	•	•	•	•	•	•	•	•	•
BOOST	•	•	•	•	•	•	•	•	•	•	•	•	•	•	•	•	•	•	•	•	•	•	•	•	•
BOOST MIX	•	•	•	•	•	•	•	•	•	•	•	•	•	•	•	•	•	•	•	•	•	•	•	•	•
BOOST NATURAL	•	•	•	•	•	•	•	•	•	•	•	•	•	•	•	•	•	•	•	•	•	•	•	•	•
BOOST PRO	•	•	•	•	•	•	•	•	•	•	•	•	•	•	•	•	•	•	•	•	•	•	•	•	•
BOOST STONE	•	•	•	•	•	•	•	•	•	•	•	•	•	•	•	•	•	•	•	•	•	•	•	•	•
BRAVE	•	•	•	•	•	•	•	•	•	•	•	•	•	•	•	•	•	•	•	•	•	•	•	•	•
ENTICE																									
ETIC PRO																									
EXENCE																									
LIMS	•	•	•	•	•	•	•	•	•	•	•	•	•	•	•	•	•	•	•	•	•	•	•	•	•
MARVEL TRAVERTINE																									
MARVEL X																									
NORDE	•	•	•	•	•	•	•	•	•	•	•	•	•	•	•	•	•	•	•	•	•	•	•	•	•
PRISM																									
TRUST	•	•	•	•	•	•	•	•	•	•	•	•	•	•	•	•	•	•	•	•	•	•	•	•	•



DOWNLOAD >  
LARGE SIZES CATALOG

 atlas concorde

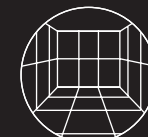

Floor & Wall



Furniture



Facades

atlasPLAN

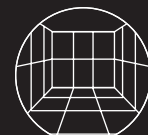

Floor & Wall



Furniture



Countertops

## Large Sizes

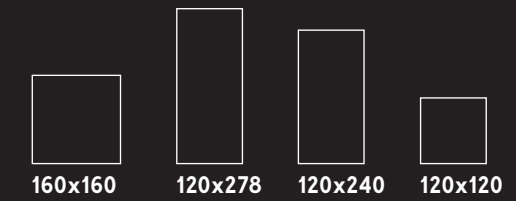

- ↔ MARBLE LOOK
- ↔ METAL LOOK
- ↔ CONCRETE LOOK
- ↔ STONE LOOK
- ↔ COLOR & DECOR LOOK

↔ NOTES



160x320

- ↔ MARBLE LOOK
- ↔ CONCRETE LOOK

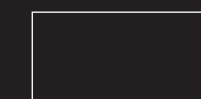

162x324 ± 6-12-20 mm  
SINGLE SLAB NON-RECTIFIED



159x324 ± 20 mm  
SINGLE SLAB NON-RECTIFIED

↔ SLABS FOR COUNTERTOPS & FURNITURE

INDEX



A COMPLETE  
PRODUCT  
SYSTEM >

PRODUCT  
FINDER >

SURFACE  
RANGE >

COMPANY >

COLLECTIONS >

LARGE SIZES >

MARBLE LOOK  
METAL LOOK  
CONCRETE LOOK  
STONE LOOK  
COLOR & DECOR LOOK  
NOTES

SLABS FOR  
COUNTERTOPS  
& FURNITURE >

SINKS &  
BATHROOM  
FURNISHING >

FACADES >

TECHNICAL  
SPECIFICATIONS >

# Large Sizes<sup>(1)</sup>

## Porcelain Tiles

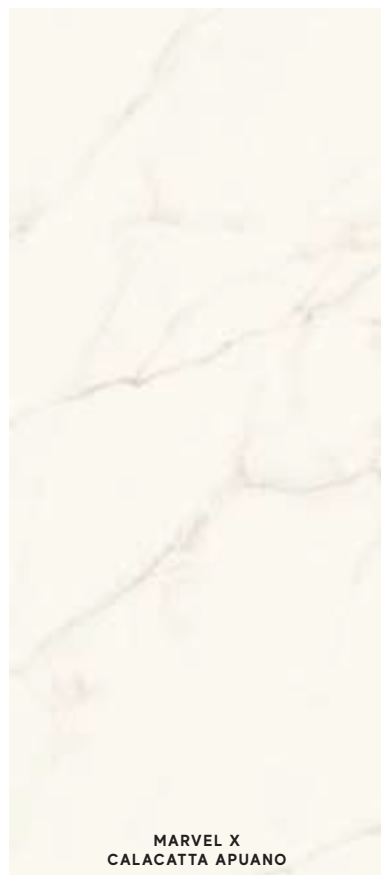

MARVEL X  
CALACATTA APUANO

Sizes	Thickness	Surface finish
<b>120x120 cm</b> - 47 <sup>1</sup> / <sub>4</sub> "x47 <sup>1</sup> / <sub>4</sub> "	± 9 mm	Polished   Silk
AFU7 Calacatta Apuano Polished AFVJ Calacatta Apuano Silk		
<b>120x240 cm</b> - 47 <sup>1</sup> / <sub>4</sub> "x94 <sup>1</sup> / <sub>2</sub> "	± 9 mm	Polished
AFU2 Calacatta Apuano		
<b>120x278 cm</b> - 47 <sup>1</sup> / <sub>4</sub> "x109 <sup>1</sup> / <sub>2</sub> "	± 6 mm	Polished   Silk
AFUS Calacatta Apuano Polished AFUX Calacatta Apuano		

### atlas<sup>PLAN</sup>

**162x324 cm** - 63<sup>3</sup>/<sub>4</sub>"x127<sup>1</sup>/<sub>2</sub>" P.402  
SINGLE SLAB NON-RECTIFIED  
FOR COUNTERTOPS & FURNITURE



MARVEL SHINE  
CALACATTA DELICATO

Sizes	Thickness	Surface finish
<b>120x120 cm</b> - 47 <sup>1</sup> / <sub>4</sub> "x47 <sup>1</sup> / <sub>4</sub> "	± 9 mm	Polished   Matte
A4Q8 Marvel Calacatta Delicato Polished A4Q4 Marvel Calacatta Delicato Matte (S)		
<b>120x240 cm</b> - 47 <sup>1</sup> / <sub>4</sub> "x94 <sup>1</sup> / <sub>2</sub> "	± 9 mm	Polished
A4RH Marvel Calacatta Delicato		
<b>120x278 cm</b> - 47 <sup>1</sup> / <sub>4</sub> "x109 <sup>1</sup> / <sub>2</sub> "	± 6 mm	Polished
A4OY Marvel Calacatta Delicato		

### atlas<sup>PLAN</sup>

**162x324 cm** - 63<sup>3</sup>/<sub>4</sub>"x127<sup>1</sup>/<sub>2</sub>" P.402  
SINGLE SLAB NON-RECTIFIED  
FOR COUNTERTOPS & FURNITURE

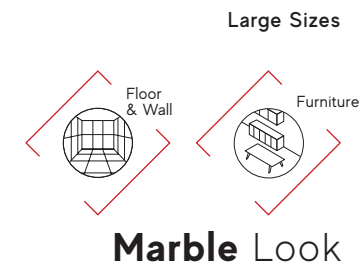

## Marble Look



MARVEL  
CALACATTA EXTRA

Sizes	Thickness	Surface finish
<b>120x120 cm</b> - 47 <sup>1</sup> / <sub>4</sub> "x47 <sup>1</sup> / <sub>4</sub> "	± 9 mm	Polished   Matte
AY2R Calacatta Extra Polished A2ØY Calacatta Extra Matte (S)		
<b>120x240 cm</b> - 47 <sup>1</sup> / <sub>4</sub> "x94 <sup>1</sup> / <sub>2</sub> "	± 9 mm	Polished
AY2N Calacatta Extra		
<b>120x278 cm</b> - 47 <sup>1</sup> / <sub>4</sub> "x109 <sup>1</sup> / <sub>2</sub> "	± 6 mm	Polished   Matte
AØBM Calacatta Extra Polished AØBT Calacatta Extra Matte		
<b>160x160 cm</b> - 63"x63"	± 6 mm	Polished   Matte
AO51 Calacatta Extra RT Polished AO54 Calacatta Extra RT Matte		

### atlas<sup>PLAN</sup>

**160x320 cm** - 63"x126" ± 6 mm Polished | Matte  
AO5U Calacatta Extra RT Polished  
AO5Y Calacatta Extra RT Matte

**162x324 cm** - 63<sup>3</sup>/<sub>4</sub>"x127<sup>1</sup>/<sub>2</sub>" P.402  
**159x324 cm** - 62<sup>2</sup>/<sub>8</sub>"x127<sup>1</sup>/<sub>2</sub>"  
SINGLE SLAB NON-RECTIFIED  
FOR COUNTERTOPS & FURNITURE

### BOOKMATCH A<sup>(3)(5)</sup> BOOKMATCH B<sup>(3)(5)</sup>

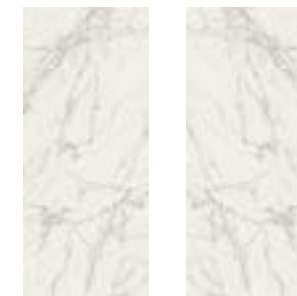

**120x278 cm** - 47<sup>1</sup>/<sub>4</sub>"x109<sup>1</sup>/<sub>2</sub>" ± 6 mm Polished  
AOTJ Calacatta Extra Polished Bookmatch A  
AOTK Calacatta Extra Polished Bookmatch B

### ENDLESS<sup>(2)(3)</sup>

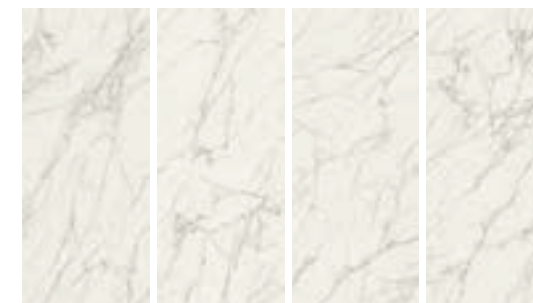

**120x278 cm** - 47<sup>1</sup>/<sub>4</sub>"x109<sup>1</sup>/<sub>2</sub>" ± 6 mm Polished  
A6DU Calacatta Extra Kit Endless Polished  
AOUB Calacatta Extra Endless Polished

\* Calacatta Extra Endless is composed of four graphics with vein continuity, but are distributed randomly in the boxes, without the possibility of choosing between the available patterns.  
(SEE PAGE 401)

<sup>(1)</sup> The various graphics of the product are distributed randomly in the boxes, without the possibility of choosing between the available patterns.

<sup>(2)</sup> The Endless Kit contains all the graphics of the product with vein continuity, ensuring that all the numbered faces in the composition can be found in a single box. The number of the graphic - G1, G2, G3, etc - is printed on the side and indicated with an adhesive label placed on the slab. To reconstruct the surface with continuous veins, simply lay the tiles in numerical progression: G1, G2, G3 and so on.

<sup>(3)</sup> Minor misalignments in the continuity of the veins between different graphics is normal for this type of product.

<sup>(5)</sup> Codes A and B are sold separately.

(translations: page 401)

### COMPLETE YOUR PROJECT

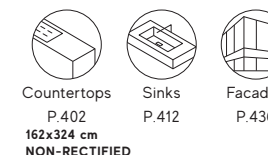

Countertops P.402  
Sinks P.412  
Facades P.436  
**162x324 cm NON-RECTIFIED**

INDEX



A COMPLETE PRODUCT SYSTEM



PRODUCT FINDER



SURFACE RANGE



COMPANY



COLLECTIONS



LARGE SIZES



MARBLE LOOK  
METAL LOOK  
CONCRETE LOOK  
STONE LOOK  
COLOR & DECOR LOOK  
NOTES

SLABS FOR COUNTERTOPS & FURNITURE



SINKS & BATHROOM FURNISHING



FACADES



TECHNICAL SPECIFICATIONS



# Large Sizes<sup>(1)</sup>

## Porcelain Tiles



MARVEL X  
CALACATTA SUBLIME

Sizes	Thickness	Surface finish
<b>120x120 cm</b> - 47 <sup>1</sup> / <sub>4</sub> "x47 <sup>1</sup> / <sub>4</sub> "	± 9 mm	Polished I Silk
A8YT Calacatta Sublime Polished AFVK Calacatta Sublime Silk		
<b>120x240 cm</b> - 47 <sup>1</sup> / <sub>4</sub> "x94 <sup>1</sup> / <sub>2</sub> "	± 9 mm	Polished
AFU3 Calacatta Sublime		
<b>120x278 cm</b> - 47 <sup>1</sup> / <sub>4</sub> "x109 <sup>1</sup> / <sub>2</sub> "	± 6 mm	Polished I Silk
AFUT Calacatta Sublime Polished AFUY Calacatta Sublime Silk		

KIT ENDLESS<sup>(2)(3)</sup>

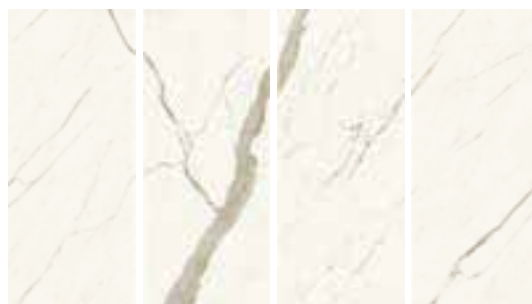

<b>120x278 cm</b> - 47 <sup>1</sup> / <sub>4</sub> "x109 <sup>1</sup> / <sub>2</sub> "	± 6 mm	Polished I Silk
AFWN Calacatta Sublime Polished Kit Endless AFWO Calacatta Sublime Silk Kit Endless		

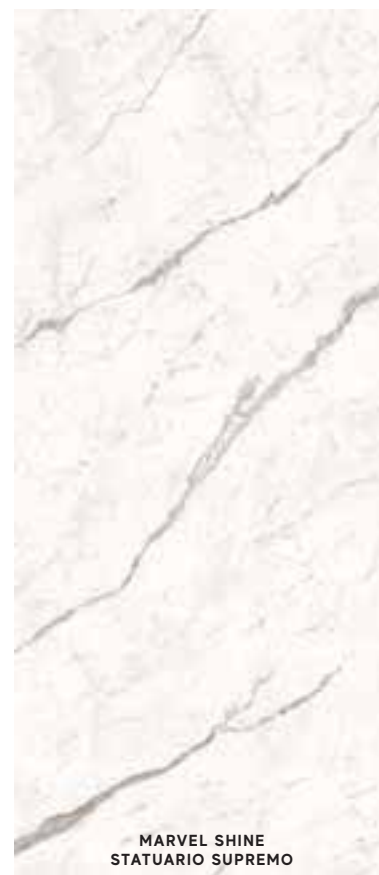

MARVEL SHINE  
STATUARIO SUPREMO

Sizes	Thickness	Surface finish
<b>120x120 cm</b> - 47 <sup>1</sup> / <sub>4</sub> "x47 <sup>1</sup> / <sub>4</sub> "	± 9 mm	Polished I Matte
A4RA Statuario Supremo Polished A4Q6 Statuario Supremo Matte (S)		
<b>120x240 cm</b> - 47 <sup>1</sup> / <sub>4</sub> "x94 <sup>1</sup> / <sub>2</sub> "	± 9 mm	Polished
A4RJ Statuario Supremo		
<b>120x278 cm</b> - 47 <sup>1</sup> / <sub>4</sub> "x109 <sup>1</sup> / <sub>2</sub> "	± 6 mm	Polished I Silk
A4OØ Statuario Supremo Polished A4O7 Statuario Supremo Silk		
<b>160x160 cm</b> - 63"x63"	± 6 mm	Polished
A4RQ Statuario Supremo		
<b>atlas<sup>PLAN</sup></b>		
<b>160x320 cm</b> - 63"x126"	± 6 mm	Polished
A4RS Statuario Supremo		
<b>162x324 cm</b> - 63 <sup>3</sup> / <sub>4</sub> "x127 <sup>1</sup> / <sub>2</sub> "	P.402	
<b>159x324 cm</b> - 62 <sup>5</sup> / <sub>8</sub> "x127 <sup>1</sup> / <sub>2</sub> "		
SINGLE SLAB NON-RECTIFIED FOR COUNTERTOPS & FURNITURE		

<sup>(1)</sup> The various graphics of the product are distributed randomly in the boxes, without the possibility of choosing between the available patterns.

<sup>(2)</sup> The Endless Kit contains all the graphics of the product with vein continuity, ensuring that all the numbered faces in the composition can be found in a single box. The number of the graphic - G1, G2, G3, etc. - is printed on the side and indicated with an adhesive label placed on the slab. To reconstruct the surface with continuous veins, simply lay the tiles in numerical progression: G1, G2, G3 and so on.

<sup>(3)</sup> Minor misalignments in the continuity of the veins between different graphics is normal for this type of product.

<sup>(4)</sup> Codes A and B are sold separately.

(translations: page 401)

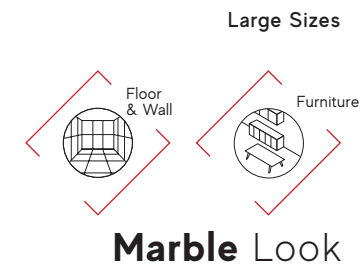

BOOKMATCH A<sup>(3)(5)</sup> BOOKMATCH B<sup>(3)(5)</sup>

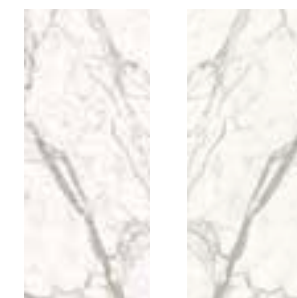

Sizes	Thickness	Surface finish
<b>120x278 cm</b> - 47 <sup>1</sup> / <sub>4</sub> "x109 <sup>1</sup> / <sub>2</sub> "	± 6 mm	Polished
A4O4 Statuario Supremo Polished Bookmatch A A4O5 Statuario Supremo Polished Bookmatch B		

KIT ENDLESS<sup>(2)(3)</sup>

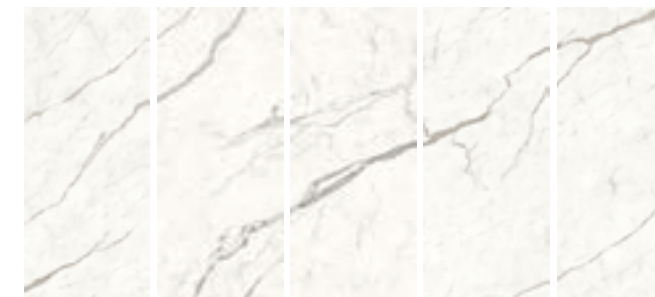

Sizes	Thickness	Surface finish
<b>120x278 cm</b> - 47 <sup>1</sup> / <sub>4</sub> "x109 <sup>1</sup> / <sub>2</sub> "	± 6 mm	Polished I Silk
A6EP Statuario Supremo Polished Kit Endless A6ES Statuario Supremo Silk Kit Endless		



Countertops P.402  
Sinks P.412  
Facades P.436  
162x324 cm  
NON-RECTIFIED

INDEX



A COMPLETE PRODUCT SYSTEM



PRODUCT FINDER



SURFACE RANGE



COMPANY



COLLECTIONS



LARGE SIZES



MARBLE LOOK  
METAL LOOK  
CONCRETE LOOK  
STONE LOOK  
COLOR & DECOR LOOK  
NOTES

SLABS FOR COUNTERTOPS & FURNITURE



SINKS & BATHROOM FURNISHING



FACADES



TECHNICAL SPECIFICATIONS



# Large Sizes<sup>(1)</sup>

## Porcelain Tiles



MARVEL SHINE  
CALACATTA IMPERIALE

KIT ENDLESS<sup>(2)(3)</sup>

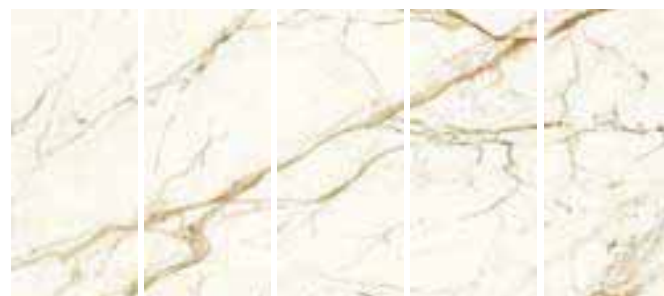

Sizes	Thickness	Surface finish
<b>120x120 cm</b> - 47 <sup>1</sup> / <sub>4</sub> "x47 <sup>1</sup> / <sub>4</sub> "	± 9 mm	Polished   Matte
A4RB Calacatta Imperiale Polished		
A4Q7 Calacatta Imperiale Matte (S)		
<b>120x240 cm</b> - 47 <sup>1</sup> / <sub>4</sub> "x94 <sup>1</sup> / <sub>2</sub> "	± 9 mm	Polished
A4RK Calacatta Imperiale		
<b>120x278 cm</b> - 47 <sup>1</sup> / <sub>4</sub> "x109 <sup>1</sup> / <sub>2</sub> "	± 6 mm	Polished
A4O1 Calacatta Imperiale		

**120x278 cm** - 47<sup>1</sup>/<sub>4</sub>"x109<sup>1</sup>/<sub>2</sub>" ± 6 mm Polished  
A6EQ Calacatta Imperiale Polished Kit Endless

### atlasPLAN

**162x324 cm** - 63<sup>3</sup>/<sub>4</sub>"x127<sup>1</sup>/<sub>2</sub>" P.402  
**159x324 cm** - 62<sup>5</sup>/<sub>8</sub>"x127<sup>1</sup>/<sub>2</sub>"  
SINGLE SLAB NON-RECTIFIED  
FOR COUNTERTOPS & FURNITURE

<sup>(1)</sup> The Endless Kit contains all the graphics of the product with vein continuity, ensuring that all the numbered faces in the composition can be found in a single box. The number of the graphic - G1, G2, G3, etc. - is printed on the side and indicated with an adhesive label placed on the slab. To reconstruct the surface with continuous veins, simply lay the tiles in numerical progression: G1, G2, G3 and so on.

<sup>(2)</sup> Minor misalignments in the continuity of the veins between different graphics is normal for this type of product.

(translations: page 401)

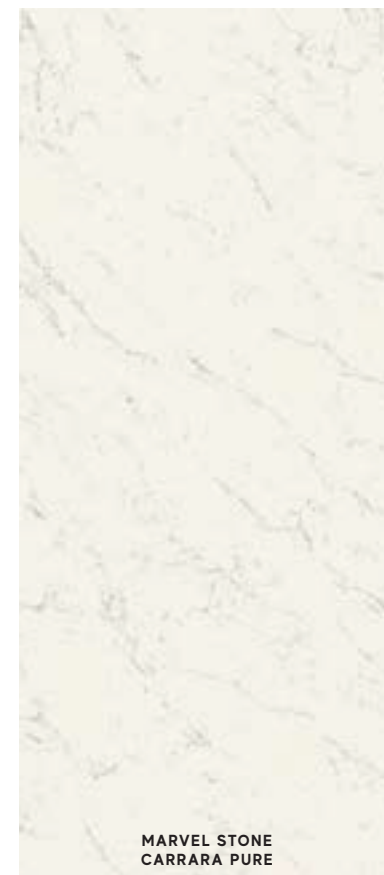
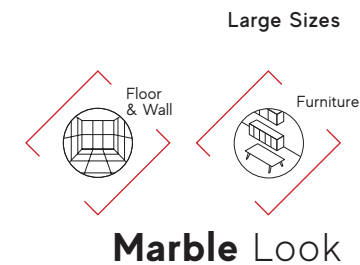

MARVEL STONE  
CARRARA PURE

Sizes	Thickness	Surface finish
<b>120x120 cm</b> - 47 <sup>1</sup> / <sub>4</sub> "x47 <sup>1</sup> / <sub>4</sub> "	± 9 mm	Polished   Matte
AZTU Carrara Pure Polished		
A2Ø7 Carrara Pure Matte (S)		
<b>120x240 cm</b> - 47 <sup>1</sup> / <sub>4</sub> "x94 <sup>1</sup> / <sub>2</sub> "	± 9 mm	Polished
AZTW Carrara Pure		
<b>120x278 cm</b> - 47 <sup>1</sup> / <sub>4</sub> "x109 <sup>1</sup> / <sub>2</sub> "	± 6 mm	Polished   Matte
A2RW Carrara Pure Polished		
A2RV Carrara Pure Matte		



MARVEL STONE  
BIANCO DOLOMITE

Sizes	Thickness	Surface finish
<b>120x120 cm</b> - 47 <sup>1</sup> / <sub>4</sub> "x47 <sup>1</sup> / <sub>4</sub> "	± 9 mm	Polished   Matte
AZTT Bianco Dolomite Polished		
A2Ø4 Bianco Dolomite Matte (S)		
<b>120x240 cm</b> - 47 <sup>1</sup> / <sub>4</sub> "x94 <sup>1</sup> / <sub>2</sub> "	± 9 mm	Polished
AZTV Bianco Dolomite		
<b>120x278 cm</b> - 47 <sup>1</sup> / <sub>4</sub> "x109 <sup>1</sup> / <sub>2</sub> "	± 6 mm	Polished   Matte
AØBP Bianco Dolomite Polished		
A2RS Bianco Dolomite Matte		
<b>160x160 cm</b> - 63"x63"	± 6 mm	Polished
AO53 Bianco Dolomite Polished RT		
<b>atlasPLAN</b>		
<b>160x320 cm</b> - 63"x126"	± 6 mm	Polished
AO5X Bianco Dolomite RT		
<b>162x324 cm</b> - 63 <sup>3</sup> / <sub>4</sub> "x127 <sup>1</sup> / <sub>2</sub> " P.402		
<b>159x324 cm</b> - 62 <sup>5</sup> / <sub>8</sub> "x127 <sup>1</sup> / <sub>2</sub> "		
SINGLE SLAB NON-RECTIFIED FOR COUNTERTOPS & FURNITURE		

(S) **Sensitech** SAFE. SOFT. SMART. P.470



INDEX



A COMPLETE  
PRODUCT  
SYSTEM



PRODUCT  
FINDER



SURFACE  
RANGE



COMPANY



COLLECTIONS



LARGE SIZES



MARBLE LOOK  
METAL LOOK  
CONCRETE LOOK  
STONE LOOK  
COLOR & DECOR LOOK  
NOTES

SLABS FOR  
COUNTERTOPS  
& FURNITURE



SINKS &  
BATHROOM  
FURNISHING



FACADES



TECHNICAL  
SPECIFICATIONS



# Large Sizes<sup>(1)</sup>

## Porcelain Tiles



MARVEL DREAM  
BIANCO FANTASTICO

Sizes	Thickness	Surface finish
<b>120x120 cm</b> - 47 <sup>1</sup> / <sub>4</sub> "x47 <sup>1</sup> / <sub>4</sub> "	± 9 mm	Polished I Matte
AL7N Bianco Fantastico Polished		
A2Ø3 Bianco Fantastico Matte (S)		
<b>120x240 cm</b> - 47 <sup>1</sup> / <sub>4</sub> "x94 <sup>1</sup> / <sub>2</sub> "	± 9 mm	Polished
AO3P Bianco Fantastico		
<b>120x278 cm</b> - 47 <sup>1</sup> / <sub>4</sub> "x109 <sup>1</sup> / <sub>2</sub> "	± 6 mm	Polished I Matte
AOSE Bianco Fantastico Polished		
A2RR Bianco Fantastico Matte		



MARVEL GALA  
CRYSTAL WHITE

Sizes	Thickness	Surface finish
<b>120x120 cm</b> - 47 <sup>1</sup> / <sub>4</sub> "x47 <sup>1</sup> / <sub>4</sub> "	± 9 mm	Polished
AFXN Crystal White		
<b>120x278 cm</b> - 47 <sup>1</sup> / <sub>4</sub> "x109 <sup>1</sup> / <sub>2</sub> "	± 6 mm	Polished
AFXW Crystal White		
<b>atlasPLAN</b>		
<b>162x324 cm</b> - 63 <sup>3</sup> / <sub>8</sub> "x127 <sup>1</sup> / <sub>2</sub> "		P.402
<b>159x324 cm</b> - 62 <sup>5</sup> / <sub>8</sub> "x127 <sup>1</sup> / <sub>2</sub> "		
SINGLE SLAB NON-RECTIFIED FOR COUNTERTOPS & FURNITURE		

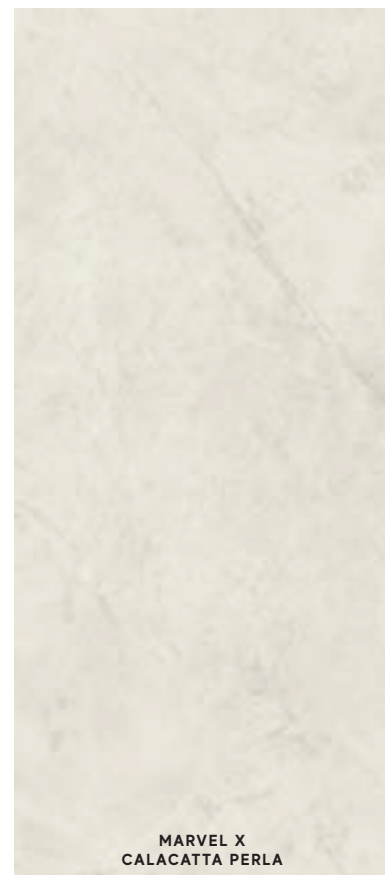

MARVEL X  
CALACATTA PERLA

Sizes	Thickness	Surface finish
<b>120x120 cm</b> - 47 <sup>1</sup> / <sub>4</sub> "x47 <sup>1</sup> / <sub>4</sub> "	± 9 mm	Polished I Silk
AFU8 Calacatta Perla Polished		
AFVL Calacatta Perla Silk		
<b>120x240 cm</b> - 47 <sup>1</sup> / <sub>4</sub> "x94 <sup>1</sup> / <sub>2</sub> "	± 9 mm	Polished
AFU4 Calacatta Perla		
<b>120x278 cm</b> - 47 <sup>1</sup> / <sub>4</sub> "x109 <sup>1</sup> / <sub>2</sub> "	± 6 mm	Polished I Silk
AFUU Calacatta Perla Polished		
AFUZ Calacatta Perla Silk		



MARVEL PRO  
CREMO DELICATO

Sizes	Thickness	Surface finish
<b>120x120 cm</b> - 47 <sup>1</sup> / <sub>4</sub> "x47 <sup>1</sup> / <sub>4</sub> "	± 9 mm	Polished I Matte
AY2U Crema Delicato Polished		
A2Ø6 Crema Delicato Matte (S)		
<b>120x240 cm</b> - 47 <sup>1</sup> / <sub>4</sub> "x94 <sup>1</sup> / <sub>2</sub> "	± 9 mm	Polished
AY2Q Crema Delicato		
<b>120x278 cm</b> - 47 <sup>1</sup> / <sub>4</sub> "x109 <sup>1</sup> / <sub>2</sub> "	± 6 mm	Polished I Matte
AØB0 Crema Delicato Polished		
A2RU Crema Delicato Matte		
<b>atlasPLAN</b>		
<b>160x160 cm</b> - 63"x63"	± 6 mm	Polished
AO52 Crema Delicato RT		
<b>160x320 cm</b> - 63"x126"	± 6 mm	Polished
AO5W Crema Delicato RT		



MARVEL EDGE  
ROYAL CALACATTA

Sizes	Thickness	Surface finish
<b>120x120 cm</b> - 47 <sup>1</sup> / <sub>4</sub> "x47 <sup>1</sup> / <sub>4</sub> "	± 9 mm	Polished
AENP Marvel Royal Calacatta		
<b>120x240 cm</b> - 47 <sup>1</sup> / <sub>4</sub> "x94 <sup>1</sup> / <sub>2</sub> "	± 9 mm	Polished
AENU Marvel Royal Calacatta		
<b>120x278 cm</b> - 47 <sup>1</sup> / <sub>4</sub> "x109 <sup>1</sup> / <sub>2</sub> "	± 6 mm	Polished
AØBH Marvel Royal Calacatta		



MARVEL PRO  
STATUARIO SELECT

Sizes	Thickness	Surface finish
<b>120x120 cm</b> - 47 <sup>1</sup> / <sub>4</sub> "x47 <sup>1</sup> / <sub>4</sub> "	± 9 mm	Polished
AY2T Statuario Select		
<b>120x240 cm</b> - 47 <sup>1</sup> / <sub>4</sub> "x94 <sup>1</sup> / <sub>2</sub> "	± 9 mm	Polished
AY2P Statuario Select		
<b>120x278 cm</b> - 47 <sup>1</sup> / <sub>4</sub> "x109 <sup>1</sup> / <sub>2</sub> "	± 6 mm	Polished
AØBN Statuario Select		

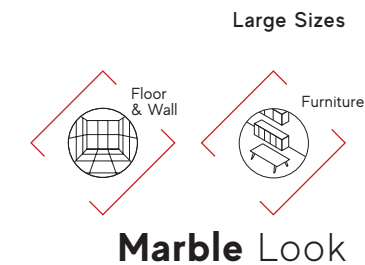

Marble Look

<sup>(1)</sup> The various graphics of the product are distributed randomly in the boxes, without the possibility of choosing between the available patterns.

(translations: page 401)

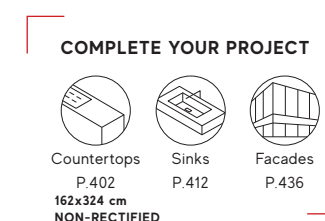

INDEX



A COMPLETE PRODUCT SYSTEM >

PRODUCT FINDER >

SURFACE RANGE >

COMPANY >

COLLECTIONS >

LARGE SIZES >

MARBLE LOOK  
METAL LOOK  
CONCRETE LOOK  
STONE LOOK  
COLOR & DECOR LOOK  
NOTES

SLABS FOR COUNTERTOPS & FURNITURE >

SINKS & BATHROOM FURNISHING >

FACADES >

TECHNICAL SPECIFICATIONS >



# Large Sizes<sup>(1)</sup>

## Porcelain Tiles

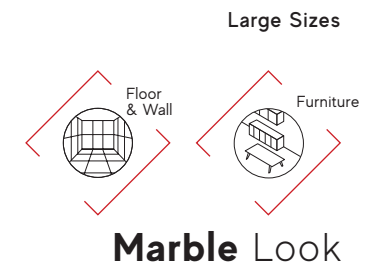

MARVEL TRAVERTINE  
WHITE VEIN CUT

Sizes	Thickness	Surface finish
120x240 cm - 47 1/4"x94 1/2"	± 9 mm	Matte
AFT7 White Vein Cut		
120x278 cm - 47 1/4"x109 1/2"	± 6 mm	Matte
AFS1 White Vein Cut		



MARVEL TRAVERTINE  
SAND VEIN CUT

Sizes	Thickness	Surface finish
120x240 cm - 47 1/4"x94 1/2"	± 9 mm	Matte
AFT8 Sand Vein Cut		
120x278 cm - 47 1/4"x109 1/2"	± 6 mm	Matte
AFS2 Sand Vein Cut		

atlas<sup>PLAN</sup>

162x324 cm - 63 3/4"x127 1/2" P.402  
SINGLE SLAB NON-RECTIFIED  
FOR COUNTERTOPS & FURNITURE

### CROSS CUT



WHITE  
CROSS CUT

120x120 cm - 47 1/4"x47 1/4" (S). See page 228



SAND  
CROSS CUT

120x120 cm - 47 1/4"x47 1/4" (S). See page 228



MARVEL TRAVERTINE  
PEARL VEIN CUT

Sizes	Thickness	Surface finish
120x240 cm - 47 1/4"x94 1/2"	± 9 mm	Matte
AFT9 Pearl Vein Cut		
120x278 cm - 47 1/4"x109 1/2"	± 6 mm	Matte
AFS3 Pearl Vein Cut		

atlas<sup>PLAN</sup>

162x324 cm - 63 3/4"x127 1/2" P.402  
SINGLE SLAB NON-RECTIFIED  
FOR COUNTERTOPS & FURNITURE

### CROSS CUT



PEARL  
CROSS CUT

120x120 cm - 47 1/4"x47 1/4" (S). See page 228



MARVEL GALA  
DESERT SOUL

Sizes	Thickness	Surface finish
120x120 cm - 47 1/4"x47 1/4"	± 9 mm	Polished
AFXM Desert Soul		
120x278 cm - 47 1/4"x109 1/2"	± 6 mm	Polished
AFXV Desert Soul		

atlas<sup>PLAN</sup>

162x324 cm - 63 3/4"x127 1/2" P.402  
SINGLE SLAB NON-RECTIFIED  
FOR COUNTERTOPS & FURNITURE



MARVEL GALA  
EXOTIC GREEN

Sizes	Thickness	Surface finish
120x120 cm - 47 1/4"x47 1/4"	± 9 mm	Polished
ABKA Exotic Green		
120x278 cm - 47 1/4"x109 1/2"	± 6 mm	Polished
AFXU Exotic Green		

atlas<sup>PLAN</sup>

162x324 cm - 63 3/4"x127 1/2" P.402  
SINGLE SLAB NON-RECTIFIED  
FOR COUNTERTOPS & FURNITURE



MARVEL GALA  
AMAZONITE

Sizes	Thickness	Surface finish
120x120 cm - 47 1/4"x47 1/4"	± 9 mm	Polished
ABKB Amazonite		
120x278 cm - 47 1/4"x109 1/2"	± 6 mm	Polished
AFXX Amazonite		

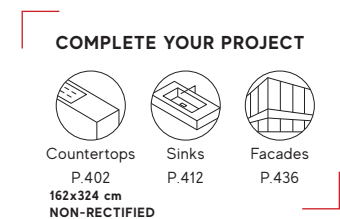

<sup>(1)</sup> The various graphics of the product are distributed randomly in the boxes, without the possibility of choosing between the available patterns.

(translations: page 401)

INDEX



A COMPLETE  
PRODUCT  
SYSTEM



PRODUCT  
FINDER



SURFACE  
RANGE



COMPANY



COLLECTIONS



LARGE SIZES



MARBLE LOOK  
METAL LOOK  
CONCRETE LOOK  
STONE LOOK  
COLOR & DECOR LOOK  
NOTES

SLABS FOR  
COUNTERTOPS  
& FURNITURE



SINKS &  
BATHROOM  
FURNISHING



FACADES



TECHNICAL  
SPECIFICATIONS



# Large Sizes<sup>(1)</sup>

## Porcelain Tiles



MARVEL X  
GREY CLOUD

Sizes	Thickness	Surface finish
<b>120x120 cm</b> - 47 <sup>1</sup> / <sub>4</sub> "x47 <sup>1</sup> / <sub>4</sub> " AFU9 Grey Cloud Polished AFVM Grey Cloud Silk	± 9 mm	Polished I Silk
<b>120x240 cm</b> - 47 <sup>1</sup> / <sub>4</sub> "x94 <sup>1</sup> / <sub>2</sub> " AFU5 Grey Cloud	± 9 mm	Polished
<b>120x278 cm</b> - 47 <sup>1</sup> / <sub>4</sub> "x109 <sup>1</sup> / <sub>2</sub> " AFUV Grey Cloud Polished AFUØ Grey Cloud Silk	± 6 mm	Polished I Silk



MARVEL X  
FIOR DI BOSCO

Sizes	Thickness	Surface finish
<b>120x120 cm</b> - 47 <sup>1</sup> / <sub>4</sub> "x47 <sup>1</sup> / <sub>4</sub> " AFVA Fior di Bosco Polished AFVN Fior di Bosco Silk	± 9 mm	Polished I Silk
<b>120x240 cm</b> - 47 <sup>1</sup> / <sub>4</sub> "x94 <sup>1</sup> / <sub>2</sub> " AFU6 Fior di Bosco	± 9 mm	Polished
<b>120x278 cm</b> - 47 <sup>1</sup> / <sub>4</sub> "x109 <sup>1</sup> / <sub>2</sub> " AFUW Fior di Bosco Polished AFU1 Fior di Bosco Silk	± 6 mm	Polished I Silk

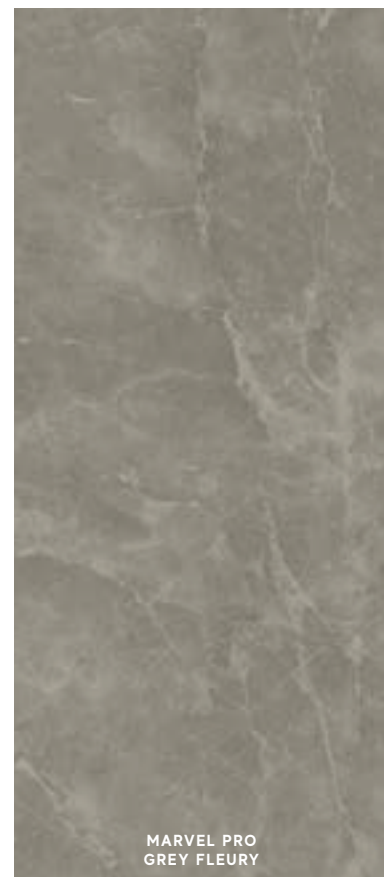

MARVEL PRO  
GREY FLEURY

Sizes	Thickness	Surface finish
<b>120x120 cm</b> - 47 <sup>1</sup> / <sub>4</sub> "x47 <sup>1</sup> / <sub>4</sub> " A21O Grey Fleury Polished A2Ø5 Grey Fleury Matte (S)	± 9 mm	Polished I Matte
<b>120x278 cm</b> - 47 <sup>1</sup> / <sub>4</sub> "x109 <sup>1</sup> / <sub>2</sub> " A2RX Grey Fleury Polished A2RT Grey Fleury Matte	± 6 mm	Polished I Matte



MARVEL  
GREY STONE

Sizes	Thickness	Surface finish
<b>120x120 cm</b> - 47 <sup>1</sup> / <sub>4</sub> "x47 <sup>1</sup> / <sub>4</sub> " AY2S Grey Stone Polished AEQY Grey Stone Matte (S)	± 9 mm	Polished I Matte
<b>120x240 cm</b> - 47 <sup>1</sup> / <sub>4</sub> "x94 <sup>1</sup> / <sub>2</sub> " AY2O Grey Stone	± 9 mm	Polished
<b>120x278 cm</b> - 47 <sup>1</sup> / <sub>4</sub> "x109 <sup>1</sup> / <sub>2</sub> " AOQD Grey Stone Polished A2RP Grey Stone Matte	± 6 mm	Polished I Matte

atlasPLAN

**162x324 cm** - 63<sup>3</sup>/<sub>4</sub>"x127<sup>1</sup>/<sub>2</sub>" P.402  
SINGLE SLAB NON-RECTIFIED  
FOR COUNTERTOPS & FURNITURE



MARVEL DREAM  
GRIGIO INTENSO

Sizes	Thickness	Surface finish
<b>120x120 cm</b> - 47 <sup>1</sup> / <sub>4</sub> "x47 <sup>1</sup> / <sub>4</sub> " AL7O Grigio Intenso	± 9 mm	Polished
<b>120x240 cm</b> - 47 <sup>1</sup> / <sub>4</sub> "x94 <sup>1</sup> / <sub>2</sub> " AO3Q Grigio Intenso	± 9 mm	Polished
<b>120x278 cm</b> - 47 <sup>1</sup> / <sub>4</sub> "x109 <sup>1</sup> / <sub>2</sub> " AOSF Grigio Intenso	± 6 mm	Polished



MARVEL EDGE  
ABSOLUTE BROWN

Sizes	Thickness	Surface finish
<b>120x120 cm</b> - 47 <sup>1</sup> / <sub>4</sub> "x47 <sup>1</sup> / <sub>4</sub> " AENO Absolute Brown	± 9 mm	Polished
<b>120x278 cm</b> - 47 <sup>1</sup> / <sub>4</sub> "x109 <sup>1</sup> / <sub>2</sub> " AOQC Absolute Brown	± 6 mm	Polished

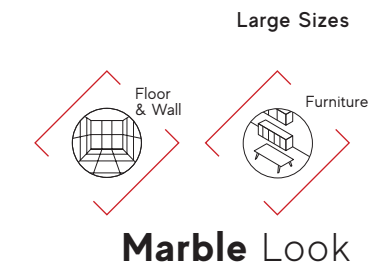

Marble Look



COMPLETE YOUR PROJECT

Countertops P.402  
Sinks P.412  
Facades P.436  
162x324 cm  
NON-RECTIFIED

<sup>(1)</sup> The various graphics of the product are distributed randomly in the boxes, without the possibility of choosing between the available patterns.

(translations: page 401)

INDEX



A COMPLETE  
PRODUCT  
SYSTEM



PRODUCT  
FINDER



SURFACE  
RANGE



COMPANY



COLLECTIONS



LARGE SIZES



MARBLE LOOK  
METAL LOOK  
CONCRETE LOOK  
STONE LOOK  
COLOR & DECOR LOOK  
NOTES

SLABS FOR  
COUNTERTOPS  
& FURNITURE



SINKS &  
BATHROOM  
FURNISHING



FACADES



TECHNICAL  
SPECIFICATIONS



# Large Sizes<sup>(1)</sup>

## Porcelain Tiles



Sizes	Thickness	Surface finish
<b>120x120 cm</b> - 47 <sup>3</sup> / <sub>4</sub> "x47 <sup>3</sup> / <sub>4</sub> "	± 9 mm	Polished   Matte
AL7P Black Atlantis Polished		
A2ØZ Black Atlantis Matte (S)		
<b>120x240 cm</b> - 47 <sup>3</sup> / <sub>4</sub> "x94 <sup>1</sup> / <sub>2</sub> "	± 9 mm	Polished
AO3R Black Atlantis		
<b>120x278 cm</b> - 47 <sup>3</sup> / <sub>4</sub> "x109 <sup>1</sup> / <sub>2</sub> "	± 6 mm	Polished   Matte
AOSG Black Atlantis Polished		
A2RQ Black Atlantis Matte		

### atlasPLAN

**162x324 cm** - 63<sup>3</sup>/<sub>4</sub>"x127<sup>1</sup>/<sub>2</sub>" P.402  
SINGLE SLAB NON-RECTIFIED  
FOR COUNTERTOPS & FURNITURE

<sup>(1)</sup> The various graphics of the product are distributed randomly in the boxes, without the possibility of choosing between the available patterns.

## Marble Look



Sizes	Thickness	Surface finish
<b>120x120 cm</b> - 47 <sup>3</sup> / <sub>4</sub> "x47 <sup>3</sup> / <sub>4</sub> "	± 9 mm	Polished
AFXO Calacatta Black		
<b>120x278 cm</b> - 47 <sup>3</sup> / <sub>4</sub> "x109 <sup>1</sup> / <sub>2</sub> "	± 6 mm	Polished
AFXY Calacatta Black		



Sizes	Thickness	Surface finish
<b>120x278 cm</b> - 47 <sup>3</sup> / <sub>4</sub> "x109 <sup>1</sup> / <sub>2</sub> "	± 6 mm	Polished
AL2I Ultramarine 120x278*		

\* Ultramarine 120x278 cm: Glazed Porcelain tiles

(translations: page 401)



Sizes	Thickness	Surface finish
<b>120x120 cm</b> - 47 <sup>3</sup> / <sub>4</sub> "x47 <sup>3</sup> / <sub>4</sub> "	± 9 mm	Matte
APPK Aluminium		
<b>120x278 cm</b> - 47 <sup>3</sup> / <sub>4</sub> "x109 <sup>1</sup> / <sub>2</sub> "	± 6 mm	Matte
APO7 Aluminium		



Sizes	Thickness	Surface finish
<b>120x120 cm</b> - 47 <sup>3</sup> / <sub>4</sub> "x47 <sup>3</sup> / <sub>4</sub> "	± 9 mm	Matte
APPW Corten		
<b>120x278 cm</b> - 47 <sup>3</sup> / <sub>4</sub> "x109 <sup>1</sup> / <sub>2</sub> "	± 6 mm	Matte
APO8 Corten		



Sizes	Thickness	Surface finish
<b>120x120 cm</b> - 47 <sup>3</sup> / <sub>4</sub> "x47 <sup>3</sup> / <sub>4</sub> "	± 9 mm	Matte
APPX Iron		
<b>120x278 cm</b> - 47 <sup>3</sup> / <sub>4</sub> "x109 <sup>1</sup> / <sub>2</sub> "	± 6 mm	Matte
APO9 Iron		

### atlasPLAN

**162x324 cm** - 63<sup>3</sup>/<sub>4</sub>"x127<sup>1</sup>/<sub>2</sub>" P.402  
SINGLE SLAB NON-RECTIFIED  
FOR COUNTERTOPS & FURNITURE

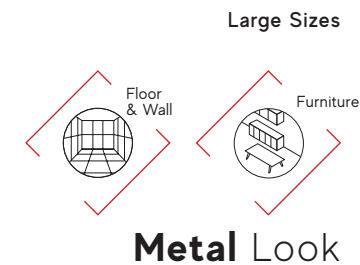

## Metal Look

**COMPLETE YOUR PROJECT**

Countertops  
P.402  
**162x324 cm  
NON-RECTIFIED**

Sinks  
P.412

Facades  
P.436

INDEX



A COMPLETE PRODUCT SYSTEM >

PRODUCT FINDER >

SURFACE RANGE >

COMPANY >

COLLECTIONS >

**LARGE SIZES** >

MARBLE LOOK  
METAL LOOK  
CONCRETE LOOK  
STONE LOOK  
COLOR & DECOR LOOK  
NOTES

SLABS FOR COUNTERTOPS & FURNITURE >

SINKS & BATHROOM FURNISHING >

FACADES >

TECHNICAL SPECIFICATIONS >

# Large Sizes<sup>(1)</sup>

## Porcelain Tiles



BOOST PRO  
IVORY

Sizes	Thickness	Surface finish
120x120 cm - 47 <sup>1</sup> / <sub>4</sub> "x47 <sup>1</sup> / <sub>4</sub> "	± 6 mm	Matte
AØCQ Ivory 6 mm	± 9 mm	Matte
AØAF Ivory 9 mm (S)		
120x240 cm - 47 <sup>1</sup> / <sub>4</sub> "x94 <sup>1</sup> / <sub>2</sub> "	± 9 mm	Matte
AØCF Ivory		
120x278 cm - 47 <sup>1</sup> / <sub>4</sub> "x109 <sup>1</sup> / <sub>2</sub> "	± 6 mm	Matte
AØCK Ivory		



BOOST NATURAL  
KAOLIN

Sizes	Thickness	Surface finish
120x120 cm - 47 <sup>1</sup> / <sub>4</sub> "x47 <sup>1</sup> / <sub>4</sub> "	± 9 mm	Matte
A65N Kaolin (S)		
120x278 cm - 47 <sup>1</sup> / <sub>4</sub> "x109 <sup>1</sup> / <sub>2</sub> "	± 6 mm	Matte
A67B Kaolin		



PRISM  
CORD

Sizes	Thickness	Surface finish
120x120 cm - 47 <sup>1</sup> / <sub>4</sub> "x47 <sup>1</sup> / <sub>4</sub> "	± 9 mm	Silk   Matte
A4ON Cord Silk		
A4OH Cord Matte (S)		
120x278 cm - 47 <sup>1</sup> / <sub>4</sub> "x109 <sup>1</sup> / <sub>2</sub> "	± 6 mm	Matte
A4UQ Cord		



BOOST PRO  
CREAM

Sizes	Thickness	Surface finish
120x120 cm - 47 <sup>1</sup> / <sub>4</sub> "x47 <sup>1</sup> / <sub>4</sub> "	± 6 mm	Matte
	± 9 mm	Matte
AØCR Cream 6 mm		
AØAH Cream 9 mm (S)		
120x240 cm - 47 <sup>1</sup> / <sub>4</sub> "x94 <sup>1</sup> / <sub>2</sub> "	± 9 mm	Matte
AØCG Cream		
120x278 cm - 47 <sup>1</sup> / <sub>4</sub> "x109 <sup>1</sup> / <sub>2</sub> "	± 6 mm	Matte
AØCM Cream		



BOOST NATURAL  
ASH

Sizes	Thickness	Surface finish
120x120 cm - 47 <sup>1</sup> / <sub>4</sub> "x47 <sup>1</sup> / <sub>4</sub> "	± 9 mm	Matte
A6WT Ash (S)		
120x278 cm - 47 <sup>1</sup> / <sub>4</sub> "x109 <sup>1</sup> / <sub>2</sub> "	± 6 mm	Matte
A67C Ash		



BOOST NATURAL  
ECRU

Sizes	Thickness	Surface finish
120x120 cm - 47 <sup>1</sup> / <sub>4</sub> "x47 <sup>1</sup> / <sub>4</sub> "	± 9 mm	Matte
A6WU Ecrú (S)		
120x278 cm - 47 <sup>1</sup> / <sub>4</sub> "x109 <sup>1</sup> / <sub>2</sub> "	± 6 mm	Matte
A67D Ecrú		

**atlas**PLAN  
162x324 cm - 63<sup>3</sup>/<sub>4</sub>"x127<sup>1</sup>/<sub>2</sub>" P.402  
SINGLE SLAB NON-RECTIFIED  
FOR COUNTERTOPS & FURNITURE

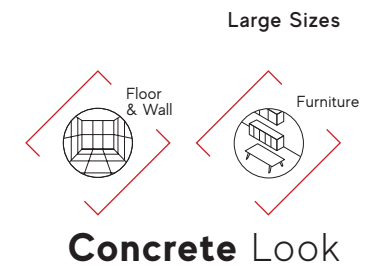

Concrete Look

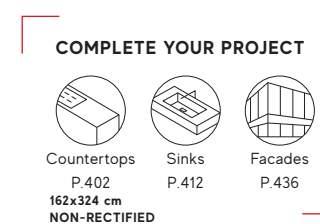

COMPLETE YOUR PROJECT

Countertops P.402  
Sinks P.412  
Facades P.436  
162x324 cm  
NON-RECTIFIED

<sup>(1)</sup> The various graphics of the product are distributed randomly in the boxes, without the possibility of choosing between the available patterns.

(translations: page 401)

INDEX



A COMPLETE  
PRODUCT  
SYSTEM >

PRODUCT  
FINDER >

SURFACE  
RANGE >

COMPANY >

COLLECTIONS >

LARGE SIZES >

MARBLE LOOK  
METAL LOOK  
CONCRETE LOOK  
STONE LOOK  
COLOR & DECOR LOOK  
NOTES

SLABS FOR  
COUNTERTOPS  
& FURNITURE >

SINKS &  
BATHROOM  
FURNISHING >

FACADES >

TECHNICAL  
SPECIFICATIONS >

# Large Sizes<sup>(1)</sup>

## Porcelain Tiles

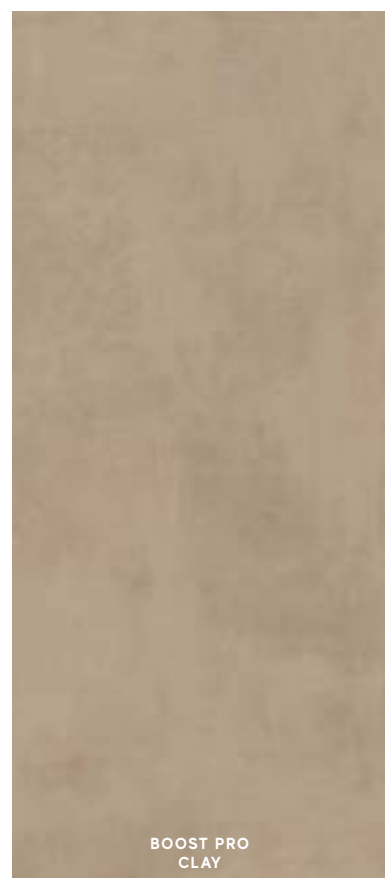
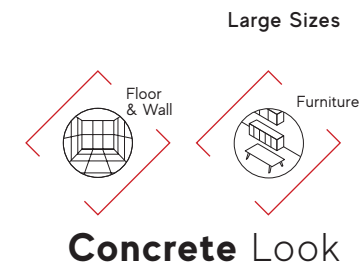

Sizes	Thickness	Surface finish
<b>120x120 cm</b> - 47 <sup>1</sup> / <sub>4</sub> "x47 <sup>1</sup> / <sub>4</sub> "	± 6 mm	Matte
AØCS Clay 6 mm	± 9 mm	Matte
AØAJ Clay 9 mm (S)		
<b>120x240 cm</b> - 47 <sup>1</sup> / <sub>4</sub> "x94 <sup>1</sup> / <sub>2</sub> "	± 9 mm	Matte
AØCJ Clay		
<b>120x278 cm</b> - 47 <sup>1</sup> / <sub>4</sub> "x109 <sup>1</sup> / <sub>2</sub> "	± 6 mm	Matte
AØCN Clay		
<b>160x160 cm</b> - 63"x63"	± 6 mm	Matte
AØQG Clay		
<b>atlasPLAN</b>		
<b>160x320 cm</b> - 63"x126"	± 6 mm	Hammered
AØQE Clay		



Sizes	Thickness	Surface finish
<b>120x120 cm</b> - 47 <sup>1</sup> / <sub>4</sub> "x47 <sup>1</sup> / <sub>4</sub> "	± 9 mm	Matte
A65R Coral (S)		
<b>120x278 cm</b> - 47 <sup>1</sup> / <sub>4</sub> "x109 <sup>1</sup> / <sub>2</sub> "	± 6 mm	Matte
A67H Coral		



Sizes	Thickness	Surface finish
<b>120x120 cm</b> - 47 <sup>1</sup> / <sub>4</sub> "x47 <sup>1</sup> / <sub>4</sub> "	± 9 mm	Silk   Matte
A4OM Suede Silk		
A4OG Suede Matte (S)		
<b>120x278 cm</b> - 47 <sup>1</sup> / <sub>4</sub> "x109 <sup>1</sup> / <sub>2</sub> "	± 6 mm	Matte
A4UP Suede		



Sizes	Thickness	Surface finish
<b>120x120 cm</b> - 47 <sup>1</sup> / <sub>4</sub> "x47 <sup>1</sup> / <sub>4</sub> "	± 6 mm	Matte
AØCT Taupe 6 mm	± 9 mm	Matte
AØAL Taupe 9 mm (S)		
<b>120x240 cm</b> - 47 <sup>1</sup> / <sub>4</sub> "x94 <sup>1</sup> / <sub>2</sub> "	± 9 mm	Matte
AØCH Taupe		
<b>120x278 cm</b> - 47 <sup>1</sup> / <sub>4</sub> "x109 <sup>1</sup> / <sub>2</sub> "	± 6 mm	Matte
AØCO Taupe		
<b>160x160 cm</b> - 63"x63"	± 6 mm	Matte
AØQH Taupe		
<b>atlasPLAN</b>		
<b>160x320 cm</b> - 63"x126"	± 6 mm	Hammered
AØQF Taupe		



Sizes	Thickness	Surface finish
<b>120x120 cm</b> - 47 <sup>1</sup> / <sub>4</sub> "x47 <sup>1</sup> / <sub>4</sub> "	± 9 mm	Matte
A65O Umber (S)		
<b>120x278 cm</b> - 47 <sup>1</sup> / <sub>4</sub> "x109 <sup>1</sup> / <sub>2</sub> "	± 6 mm	Matte
A67E Umber		

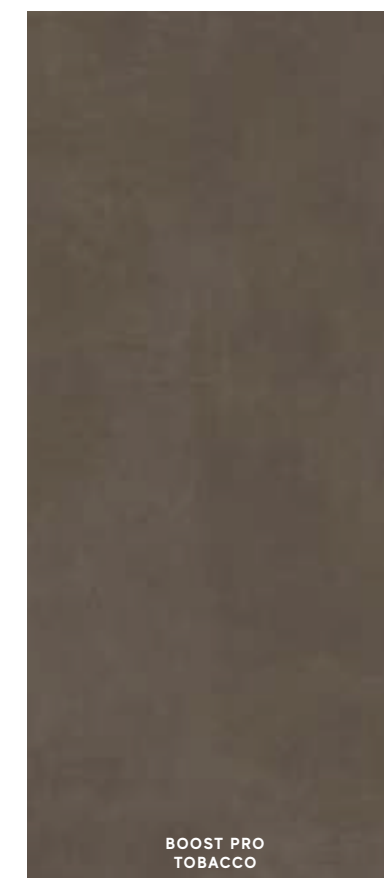

Sizes	Thickness	Surface finish
<b>120x120 cm</b> - 47 <sup>1</sup> / <sub>4</sub> "x47 <sup>1</sup> / <sub>4</sub> "	± 6 mm	Matte
AØCU Tobacco 6 mm	± 9 mm	Matte
AØAN Tobacco 9 mm (S)		
<b>120x240 cm</b> - 47 <sup>1</sup> / <sub>4</sub> "x94 <sup>1</sup> / <sub>2</sub> "	± 9 mm	Matte
AØCI Tobacco		
<b>120x278 cm</b> - 47 <sup>1</sup> / <sub>4</sub> "x109 <sup>1</sup> / <sub>2</sub> "	± 6 mm	Matte
AØCP Tobacco		

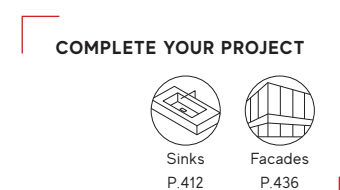

<sup>(1)</sup> The various graphics of the product are distributed randomly in the boxes, without the possibility of choosing between the available patterns.

(translations: page 401)

INDEX



A COMPLETE PRODUCT SYSTEM >

PRODUCT FINDER >

SURFACE RANGE >

COMPANY >

COLLECTIONS >

LARGE SIZES >

MARBLE LOOK  
METAL LOOK  
CONCRETE LOOK  
STONE LOOK  
COLOR & DECOR LOOK  
NOTES

SLABS FOR COUNTERTOPS & FURNITURE >

SINKS & BATHROOM FURNISHING >

FACADES >

TECHNICAL SPECIFICATIONS >

# Large Sizes<sup>(1)</sup>

## Porcelain Tiles

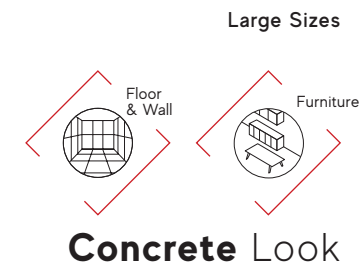

Sizes	Thickness	Surface finish
<b>120x120 cm</b> - 47 <sup>1</sup> / <sub>4</sub> "x47 <sup>1</sup> / <sub>4</sub> "	± 9 mm	Silk   Matte
A4OO Cotton Silk		
A4OI Cotton Matte (S)		
<b>120x278 cm</b> - 47 <sup>1</sup> / <sub>4</sub> "x109 <sup>1</sup> / <sub>2</sub> "	± 6 mm	Matte
A4UR Cotton		



Sizes	Thickness	Surface finish
<b>120x120 cm</b> - 47 <sup>1</sup> / <sub>4</sub> "x47 <sup>1</sup> / <sub>4</sub> "	± 6 mm	Matte
A4OP Prism Cloud Silk		
A4OJ Prism Cloud Matte (S)		
A2TK White 6 mm		
AMGI White 9 mm (S)		
<b>120x240 cm</b> - 47 <sup>1</sup> / <sub>4</sub> "x94 <sup>1</sup> / <sub>2</sub> "	± 9 mm	Matte
AMGD White		
<b>120x278 cm</b> - 47 <sup>1</sup> / <sub>4</sub> "x109 <sup>1</sup> / <sub>2</sub> "	± 6 mm	Matte
AØBD White		
<b>160x160 cm</b> - 63"x63"	± 6 mm	Matte
AØDE White RT		
<b>atlas<sup>PLAN</sup></b>		
<b>160x320 cm</b> - 63"x126"	± 6 mm	Hammered
AOSZ White RT		
<b>162x324 cm</b> - 63 <sup>3</sup> / <sub>4</sub> "x127 <sup>1</sup> / <sub>2</sub> "		P.402
SINGLE SLAB NON-RECTIFIED FOR COUNTERTOPS & FURNITURE		



Sizes	Thickness	Surface finish
<b>120x120 cm</b> - 47 <sup>1</sup> / <sub>4</sub> "x47 <sup>1</sup> / <sub>4</sub> "	± 9 mm	Silk   Matte
A4OP Prism Cloud Silk		
A4OJ Prism Cloud Matte (S)		
<b>120x278 cm</b> - 47 <sup>1</sup> / <sub>4</sub> "x109 <sup>1</sup> / <sub>2</sub> "	± 6 mm	Matte
A4US Cloud		



Sizes	Thickness	Surface finish
<b>120x120 cm</b> - 47 <sup>1</sup> / <sub>4</sub> "x47 <sup>1</sup> / <sub>4</sub> "	± 6 mm	Matte
A4OQ Fog Silk		
A4OK Fog Matte (S)		
A2TM Pearl 6 mm		
AMGJ Pearl 9 mm (S)		
<b>120x240 cm</b> - 47 <sup>1</sup> / <sub>4</sub> "x94 <sup>1</sup> / <sub>2</sub> "	± 9 mm	Matte
AMGE Pearl		
<b>120x278 cm</b> - 47 <sup>1</sup> / <sub>4</sub> "x109 <sup>1</sup> / <sub>2</sub> "	± 6 mm	Matte
AØBE Pearl		



Sizes	Thickness	Surface finish
<b>120x120 cm</b> - 47 <sup>1</sup> / <sub>4</sub> "x47 <sup>1</sup> / <sub>4</sub> "	± 9 mm	Silk   Matte
A4OQ Fog Silk		
A4OK Fog Matte (S)		
<b>120x278 cm</b> - 47 <sup>1</sup> / <sub>4</sub> "x109 <sup>1</sup> / <sub>2</sub> "	± 6 mm	Matte
A4UT Fog		



Sizes	Thickness	Surface finish
<b>120x120 cm</b> - 47 <sup>1</sup> / <sub>4</sub> "x47 <sup>1</sup> / <sub>4</sub> "	± 6 mm	Matte
A2TN Grey 6 mm		
AMGK Grey 9 mm (S)		
<b>120x240 cm</b> - 47 <sup>1</sup> / <sub>4</sub> "x94 <sup>1</sup> / <sub>2</sub> "	± 9 mm	Matte
AMGF Grey		
<b>120x278 cm</b> - 47 <sup>1</sup> / <sub>4</sub> "x109 <sup>1</sup> / <sub>2</sub> "	± 6 mm	Matte
AØBF Grey		
<b>160x160 cm</b> - 63"x63"	± 6 mm	Matte
A68K Grey RT		
<b>atlas<sup>PLAN</sup></b>		
<b>160x320 cm</b> - 63"x126"	± 6 mm	Hammered
A68I Grey RT		
<b>162x324 cm</b> - 63 <sup>3</sup> / <sub>4</sub> "x127 <sup>1</sup> / <sub>2</sub> "		P.402
SINGLE SLAB NON-RECTIFIED FOR COUNTERTOPS & FURNITURE		



<sup>(1)</sup> The various graphics of the product are distributed randomly in the boxes, without the possibility of choosing between the available patterns.

(translations: page 401)

INDEX



A COMPLETE PRODUCT SYSTEM >

PRODUCT FINDER >

SURFACE RANGE >

COMPANY >

COLLECTIONS >

LARGE SIZES >

MARBLE LOOK  
METAL LOOK  
CONCRETE LOOK  
STONE LOOK  
COLOR & DECOR LOOK  
NOTES

SLABS FOR COUNTERTOPS & FURNITURE >

SINKS & BATHROOM FURNISHING >

FACADES >

TECHNICAL SPECIFICATIONS >

# Large Sizes<sup>(1)</sup>

## Porcelain Tiles



Sizes	Thickness	Surface finish
<b>120x120 cm</b> - 47 <sup>1</sup> / <sub>4</sub> "x47 <sup>1</sup> / <sub>4</sub> "	± 6 mm	Matte
A2TO Smoke 6 mm	± 9 mm	Matte
AMGL Smoke 9 mm (S)		
<b>120x240 cm</b> - 47 <sup>1</sup> / <sub>4</sub> "x94 <sup>1</sup> / <sub>2</sub> "	± 9 mm	Matte
AMGG Smoke		
<b>120x278 cm</b> - 47 <sup>1</sup> / <sub>4</sub> "x109 <sup>1</sup> / <sub>2</sub> "	± 6 mm	Matte
AØBG Smoke		
<b>160x160 cm</b> - 63"x63"	± 6 mm	Matte
AØDF Smoke RT		
<b>atlas<sup>PLAN</sup></b>		
<b>160x320 cm</b> - 63"x126"	± 6 mm	Hammered
AO5Ø Smoke RT		
<b>162x324 cm</b> - 63 <sup>3</sup> / <sub>4</sub> "x127 <sup>1</sup> / <sub>2</sub> " P.402		
SINGLE SLAB NON-RECTIFIED FOR COUNTERTOPS & FURNITURE		



Sizes	Thickness	Surface finish
<b>120x120 cm</b> - 47 <sup>1</sup> / <sub>4</sub> "x47 <sup>1</sup> / <sub>4</sub> "	± 9 mm	Matte
A65P Coal (S)		
<b>120x278 cm</b> - 47 <sup>1</sup> / <sub>4</sub> "x109 <sup>1</sup> / <sub>2</sub> "	± 6 mm	Matte
A67F Coal		



Sizes	Thickness	Surface finish
<b>120x120 cm</b> - 47 <sup>1</sup> / <sub>4</sub> "x47 <sup>1</sup> / <sub>4</sub> "	± 6 mm	Matte
A2TP Tarmac 6 mm	± 9 mm	Matte
AMGM Tarmac 9 mm (S)		
<b>120x240 cm</b> - 47 <sup>1</sup> / <sub>4</sub> "x94 <sup>1</sup> / <sub>2</sub> "	± 9 mm	Matte
AMGH Tarmac		
<b>120x278 cm</b> - 47 <sup>1</sup> / <sub>4</sub> "x109 <sup>1</sup> / <sub>2</sub> "	± 6 mm	Matte
AOQB Tarmac		
<b>160x160 cm</b> - 63"x63"	± 6 mm	Matte
A68L Tarmac RT		
<b>atlas<sup>PLAN</sup></b>		
<b>160x320 cm</b> - 63"x126"	± 6 mm	Hammered
A68J Tarmac RT		
<b>162x324 cm</b> - 63 <sup>3</sup> / <sub>4</sub> "x127 <sup>1</sup> / <sub>2</sub> " P.402		
SINGLE SLAB NON-RECTIFIED FOR COUNTERTOPS & FURNITURE		

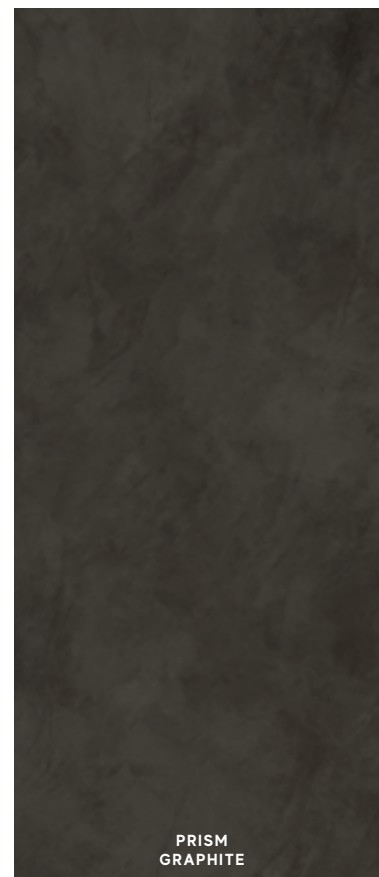

Sizes	Thickness	Surface finish
<b>120x120 cm</b> - 47 <sup>1</sup> / <sub>4</sub> "x47 <sup>1</sup> / <sub>4</sub> "	± 9 mm	Silk   Matte
A4OR Graphite Silk		
A4OL Graphite Matte (S)		
<b>120x278 cm</b> - 47 <sup>1</sup> / <sub>4</sub> "x109 <sup>1</sup> / <sub>2</sub> "	± 6 mm	Matte
A4UU Graphite		

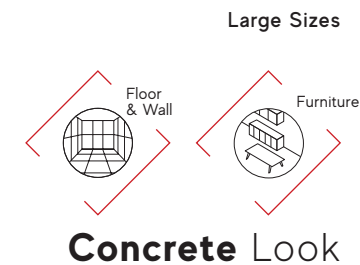

Concrete Look

- INDEX
- A COMPLETE PRODUCT SYSTEM >
- PRODUCT FINDER >
- SURFACE RANGE >
- COMPANY >
- COLLECTIONS >
- LARGE SIZES** >
- MARBLE LOOK
- METAL LOOK
- CONCRETE LOOK
- STONE LOOK
- COLOR & DECOR LOOK
- NOTES
- SLABS FOR COUNTERTOPS & FURNITURE >
- SINKS & BATHROOM FURNISHING >
- FACADES >
- TECHNICAL SPECIFICATIONS >

**COMPLETE YOUR PROJECT**

Countertops  
P.402  
**162x324 cm  
NON-RECTIFIED**

Sinks  
P.412

Facades  
P.436

<sup>(1)</sup> The various graphics of the product are distributed randomly in the boxes, without the possibility of choosing between the available patterns.

(translations: page 401)

# Large Sizes<sup>(1)</sup>

## Porcelain Tiles

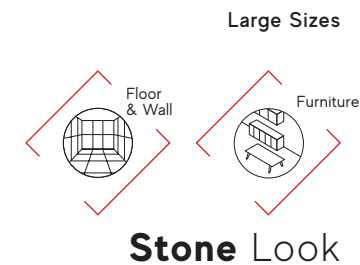

BOOST MIX  
IVORY

**Sizes**      **Thickness**   **Surface finish**

**120x120 cm** - 47<sup>1</sup>/<sub>4</sub>"x47<sup>1</sup>/<sub>4</sub>"    ± 9 mm    Matte  
A8XD Ivory (S)

**120x278 cm** - 47<sup>1</sup>/<sub>4</sub>"x109<sup>1</sup>/<sub>2</sub>"    ± 6 mm    Matte  
A8Y7 Ivory



LIMS  
IVORY

**Sizes**      **Thickness**   **Surface finish**

**120x120 cm** - 47<sup>1</sup>/<sub>4</sub>"x47<sup>1</sup>/<sub>4</sub>"    ± 9 mm    Matte  
A3DI Ivory (S)

**120x278 cm** - 47<sup>1</sup>/<sub>4</sub>"x109<sup>1</sup>/<sub>2</sub>"    ± 6 mm    Matte  
A3EI Ivory



BOOST STONE  
IVORY

**Sizes**      **Thickness**   **Surface finish**

**120x120 cm** - 47<sup>1</sup>/<sub>4</sub>"x47<sup>1</sup>/<sub>4</sub>"    ± 9 mm    Matte  
A6QT Ivory (S)

**120x278 cm** - 47<sup>1</sup>/<sub>4</sub>"x109<sup>1</sup>/<sub>2</sub>"    ± 6 mm    Matte  
A6R8 Ivory Matte

**atlasPLAN**

**162x324 cm** - 63<sup>3</sup>/<sub>4</sub>"x127<sup>1</sup>/<sub>2</sub>"    P.402  
SINGLE SLAB NON-RECTIFIED  
FOR COUNTERTOPS & FURNITURE

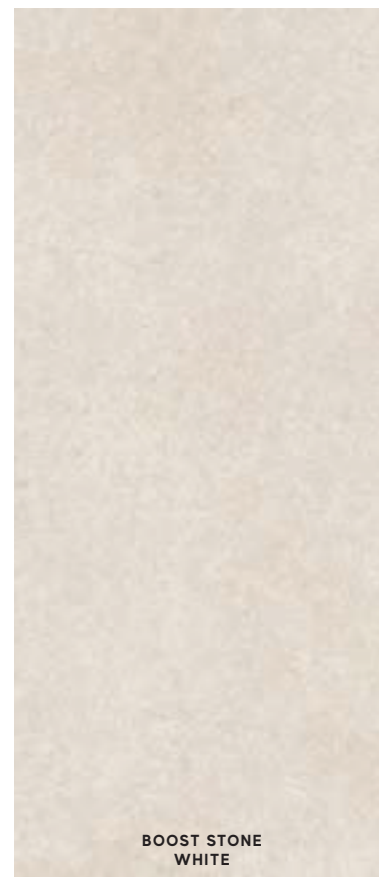

BOOST STONE  
WHITE

**Sizes**      **Thickness**   **Surface finish**

**120x120 cm** - 47<sup>1</sup>/<sub>4</sub>"x47<sup>1</sup>/<sub>4</sub>"    ± 9 mm    Matte  
A6QS White (S)

**120x278 cm** - 47<sup>1</sup>/<sub>4</sub>"x109<sup>1</sup>/<sub>2</sub>"    ± 6 mm    Matte  
A6R7 White

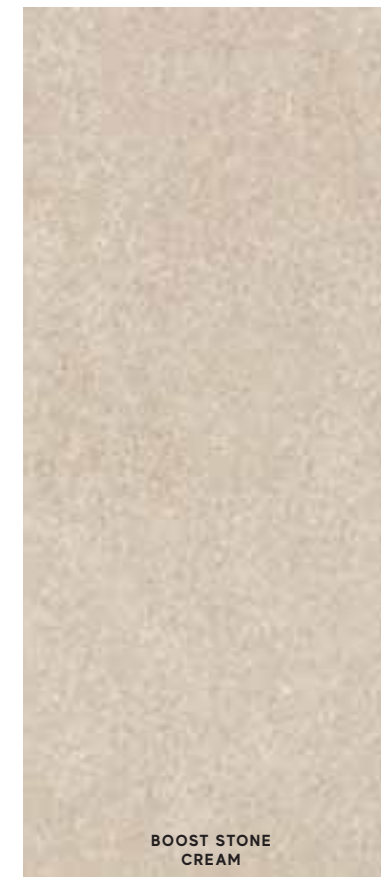

BOOST STONE  
CREAM

**Sizes**      **Thickness**   **Surface finish**

**120x120 cm** - 47<sup>1</sup>/<sub>4</sub>"x47<sup>1</sup>/<sub>4</sub>"    ± 9 mm    Matte  
A6QU Cream (S)

**120x278 cm** - 47<sup>1</sup>/<sub>4</sub>"x109<sup>1</sup>/<sub>2</sub>"    ± 6 mm    Matte  
A6R9 Cream



LIMS  
BEIGE

**Sizes**      **Thickness**   **Surface finish**

**120x120 cm** - 47<sup>1</sup>/<sub>4</sub>"x47<sup>1</sup>/<sub>4</sub>"    ± 9 mm    Matte  
A3DJ Beige (S)

**120x278 cm** - 47<sup>1</sup>/<sub>4</sub>"x109<sup>1</sup>/<sub>2</sub>"    ± 6 mm    Matte  
A3EJ Beige

<sup>(1)</sup> The various graphics of the product are distributed randomly in the boxes, without the possibility of choosing between the available patterns.

(translations: page 401)

**COMPLETE YOUR PROJECT**

Countertops P.402  
Sinks P.412  
Facades P.436  
162x324 cm  
NON-RECTIFIED

INDEX



A COMPLETE  
PRODUCT  
SYSTEM



PRODUCT  
FINDER



SURFACE  
RANGE



COMPANY



COLLECTIONS



LARGE SIZES



MARBLE LOOK  
METAL LOOK  
CONCRETE LOOK  
STONE LOOK  
COLOR & DECOR LOOK  
NOTES

SLABS FOR  
COUNTERTOPS  
& FURNITURE



SINKS &  
BATHROOM  
FURNISHING



FACADES



TECHNICAL  
SPECIFICATIONS





# Large Sizes<sup>(1)</sup>

## Porcelain Tiles



LIMS  
GREY

Sizes	Thickness	Surface finish
<b>120x120 cm</b> - 47 <sup>1</sup> / <sub>4</sub> "x47 <sup>1</sup> / <sub>4</sub> " A3DK Grey (S)	± 9 mm	Matte
<b>120x278 cm</b> - 47 <sup>1</sup> / <sub>4</sub> "x109 <sup>1</sup> / <sub>2</sub> " A3EK Grey	± 6 mm	Matte

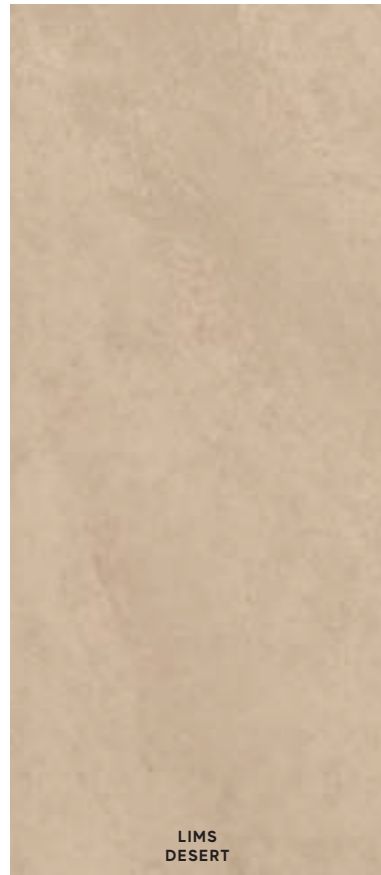

LIMS  
DESERT

Sizes	Thickness	Surface finish
<b>120x120 cm</b> - 47 <sup>1</sup> / <sub>4</sub> "x47 <sup>1</sup> / <sub>4</sub> " A3DL Desert (S)	± 9 mm	Matte
<b>120x278 cm</b> - 47 <sup>1</sup> / <sub>4</sub> "x109 <sup>1</sup> / <sub>2</sub> " A3EL Desert	± 6 mm	Matte

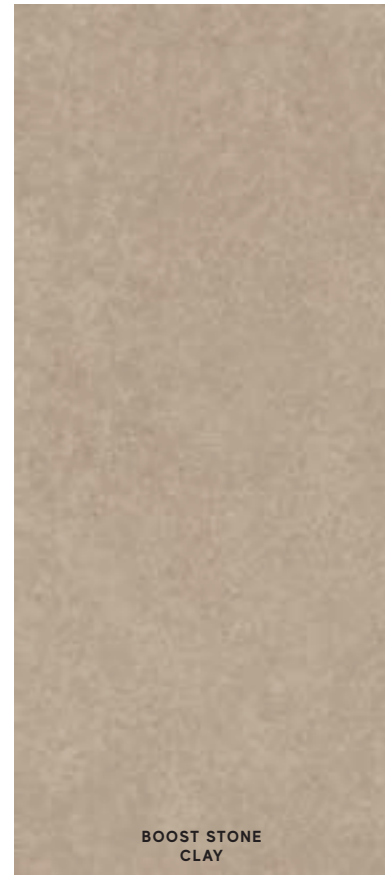

BOOST STONE  
CLAY

Sizes	Thickness	Surface finish
<b>120x120 cm</b> - 47 <sup>1</sup> / <sub>4</sub> "x47 <sup>1</sup> / <sub>4</sub> " A6QV Clay (S)	± 9 mm	Matte
<b>120x278 cm</b> - 47 <sup>1</sup> / <sub>4</sub> "x109 <sup>1</sup> / <sub>2</sub> " A6SA Clay	± 6 mm	Matte



BOOST STONE  
TAUPE

Sizes	Thickness	Surface finish
<b>120x120 cm</b> - 47 <sup>1</sup> / <sub>4</sub> "x47 <sup>1</sup> / <sub>4</sub> " A6QW Taupe (S)	± 9 mm	Matte
<b>120x278 cm</b> - 47 <sup>1</sup> / <sub>4</sub> "x109 <sup>1</sup> / <sub>2</sub> " A6SB Taupe	± 6 mm	Matte



BOOST STONE  
TOBACCO

Sizes	Thickness	Surface finish
<b>120x120 cm</b> - 47 <sup>1</sup> / <sub>4</sub> "x47 <sup>1</sup> / <sub>4</sub> " A6QZ Tobacco (S)	± 9 mm	Matte
<b>120x278 cm</b> - 47 <sup>1</sup> / <sub>4</sub> "x109 <sup>1</sup> / <sub>2</sub> " A6SF Tobacco	± 6 mm	Matte

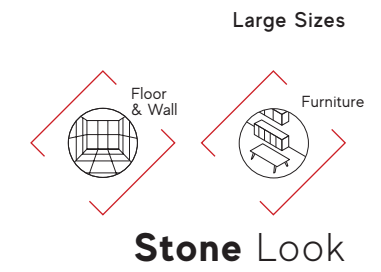

Stone Look

<sup>(1)</sup> The various graphics of the product are distributed randomly in the boxes, without the possibility of choosing between the available patterns.

(translations: page 401)

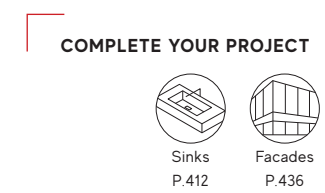

INDEX



A COMPLETE  
PRODUCT  
SYSTEM



PRODUCT  
FINDER



SURFACE  
RANGE



COMPANY



COLLECTIONS



LARGE SIZES



MARBLE LOOK  
METAL LOOK  
CONCRETE LOOK  
STONE LOOK  
COLOR & DECOR LOOK  
NOTES

SLABS FOR  
COUNTERTOPS  
& FURNITURE



SINKS &  
BATHROOM  
FURNISHING



FACADES



TECHNICAL  
SPECIFICATIONS



# Large Sizes<sup>(1)</sup>

## Porcelain Tiles

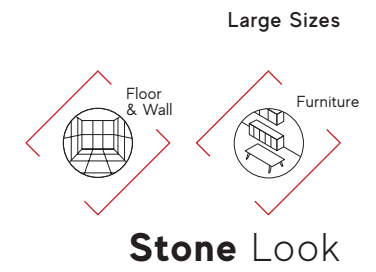

BOOST MIX PEARL

Sizes	Thickness	Surface finish
120x120 cm - 47 1/4" x 47 1/4" A8XE Pearl (S)	± 9 mm	Matte
120x278 cm - 47 1/4" x 109 1/2" A8Y8 Pearl	± 6 mm	Matte

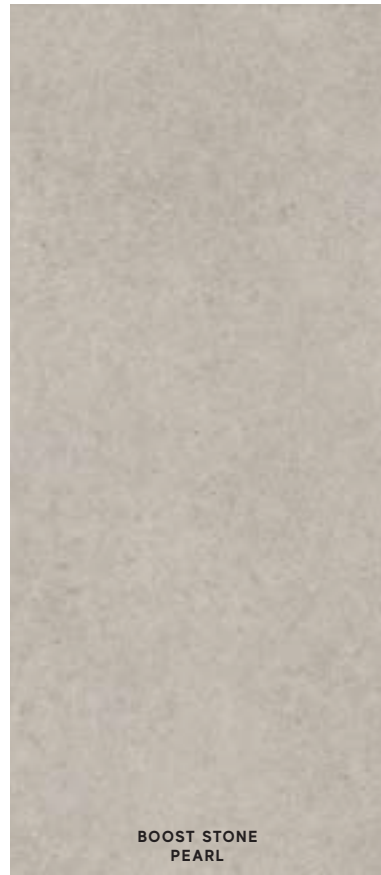

BOOST STONE PEARL

Sizes	Thickness	Surface finish
120x120 cm - 47 1/4" x 47 1/4" A6QX Pearl (S)	± 9 mm	Matte
120x278 cm - 47 1/4" x 109 1/2" A6SC Pearl	± 6 mm	Matte



BOOST STONE GREY

Sizes	Thickness	Surface finish
120x120 cm - 47 1/4" x 47 1/4" A6QY Grey (S)	± 9 mm	Matte
120x278 cm - 47 1/4" x 109 1/2" A6SD Grey	± 6 mm	Matte



BOOST STONE SMOKE

Sizes	Thickness	Surface finish
120x120 cm - 47 1/4" x 47 1/4" A6L8 Smoke (S)	± 9 mm	Matte
120x278 cm - 47 1/4" x 109 1/2" A6SE Smoke	± 6 mm	Matte



BOOST MIX SMOKE

Sizes	Thickness	Surface finish
120x120 cm - 47 1/4" x 47 1/4" A8XF Smoke (S)	± 9 mm	Matte
120x278 cm - 47 1/4" x 109 1/2" A8Y9 Smoke	± 6 mm	Matte



BOOST STONE TARMAC

Sizes	Thickness	Surface finish
120x120 cm - 47 1/4" x 47 1/4" A6QØ Tarmac (S)	± 9 mm	Matte
120x278 cm - 47 1/4" x 109 1/2" A6SG Tarmac	± 6 mm	Matte

<sup>(1)</sup> The various graphics of the product are distributed randomly in the boxes, without the possibility of choosing between the available patterns.

(translations: page 401)

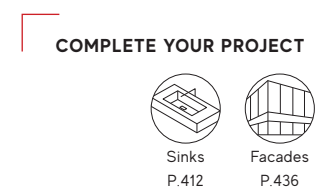

INDEX



A COMPLETE PRODUCT SYSTEM >

PRODUCT FINDER >

SURFACE RANGE >

COMPANY >

COLLECTIONS >

LARGE SIZES >

MARBLE LOOK  
METAL LOOK  
CONCRETE LOOK  
STONE LOOK  
COLOR & DECOR LOOK  
NOTES

SLABS FOR COUNTERTOPS & FURNITURE >

SINKS & BATHROOM FURNISHING >

FACADES >

TECHNICAL SPECIFICATIONS >

# Large Sizes<sup>(1)</sup>

## Porcelain Tiles



MARVEL STONE  
CLAUZETTO WHITE

Sizes	Thickness	Surface finish
120x120 cm - 47 <sup>1</sup> / <sub>4</sub> "x47 <sup>1</sup> / <sub>4</sub> " AZT5 Clauzetto White (S)	± 9 mm	Matte
120x240 cm - 47 <sup>1</sup> / <sub>4</sub> "x94 <sup>1</sup> / <sub>2</sub> " AZT2 Clauzetto White	± 9 mm	Matte

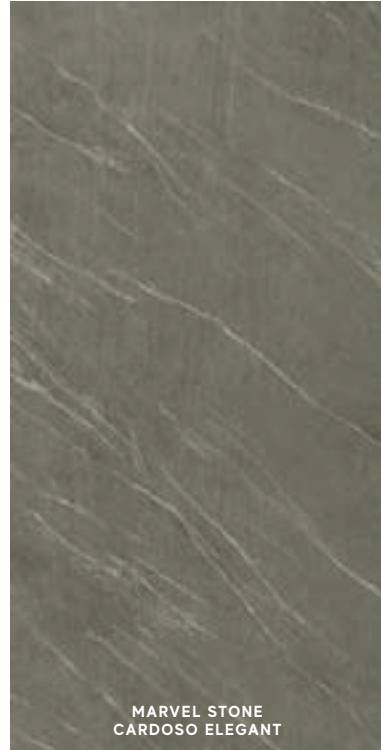

MARVEL STONE  
CARDOSO ELEGANT

Sizes	Thickness	Surface finish
120x120 cm - 47 <sup>1</sup> / <sub>4</sub> "x47 <sup>1</sup> / <sub>4</sub> " AZT4 Cardoso Elegant (S)	± 9 mm	Matte
120x240 cm - 47 <sup>1</sup> / <sub>4</sub> "x94 <sup>1</sup> / <sub>2</sub> " AZT1 Cardoso Elegant	± 9 mm	Matte



MARVEL STONE  
BASALTINA VOLCANO

Sizes	Thickness	Surface finish
120x120 cm - 47 <sup>1</sup> / <sub>4</sub> "x47 <sup>1</sup> / <sub>4</sub> " AZT3 Basaltina Volcano (S)	± 9 mm	Matte
120x240 cm - 47 <sup>1</sup> / <sub>4</sub> "x94 <sup>1</sup> / <sub>2</sub> " AZTØ Basaltina Volcano	± 9 mm	Matte

### atlasPLAN

162x324 cm - 63<sup>3</sup>/<sub>4</sub>"x127<sup>1</sup>/<sub>2</sub>" P.402  
SINGLE SLAB NON-RECTIFIED  
FOR COUNTERTOPS & FURNITURE

## Stone Look

## Glazed Porcelain Tiles



PRISM  
BLOOM

Sizes	Thickness	Surface finish
120x278 cm - 47 <sup>1</sup> / <sub>4</sub> "x109 <sup>1</sup> / <sub>2</sub> " A4VH Bloom <sup>(4)</sup> (see page 401)	± 6 mm	Matte



PRISM  
CAMEL

Sizes	Thickness	Surface finish
120x278 cm - 47 <sup>1</sup> / <sub>4</sub> "x109 <sup>1</sup> / <sub>2</sub> " A4VI Caramel <sup>(4)</sup> (see page 401)	± 6 mm	Matte



PRISM  
GRAPE

Sizes	Thickness	Surface finish
120x278 cm - 47 <sup>1</sup> / <sub>4</sub> "x109 <sup>1</sup> / <sub>2</sub> " A4VJ Grape <sup>(4)</sup> (see page 401)	± 6 mm	Matte

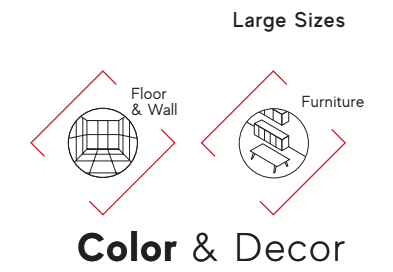

### COMPLETE YOUR PROJECT

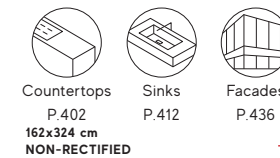

<sup>(1)</sup> The various graphics of the product are distributed randomly in the boxes, without the possibility of choosing between the available patterns.

<sup>(4)</sup> The use of a common mild detergent is recommended. Avoid using acidic or alkaline products, waxes, steel wool, or abrasives.

The decoration can only be laid on the wall

(translations: page 401)

INDEX



A COMPLETE  
PRODUCT  
SYSTEM



PRODUCT  
FINDER



SURFACE  
RANGE



COMPANY



COLLECTIONS



LARGE SIZES



MARBLE LOOK  
METAL LOOK  
CONCRETE LOOK  
STONE LOOK  
COLOR & DECOR LOOK

NOTES

SLABS FOR  
COUNTERTOPS  
& FURNITURE



SINKS &  
BATHROOM  
FURNISHING



FACADES



TECHNICAL  
SPECIFICATIONS



# Large Sizes<sup>(1)</sup>

## Glazed Porcelain Tiles



Sizes	Thickness	Surface finish
<b>120x120 cm</b> - 47 <sup>1</sup> / <sub>4</sub> "x47 <sup>1</sup> / <sub>4</sub> " A65Q Cobalt	± 9 mm	Matte
<b>120x278 cm</b> - 47 <sup>1</sup> / <sub>4</sub> "x109 <sup>1</sup> / <sub>2</sub> " A67G Cobalt	± 6 mm	Matte



Sizes	Thickness	Surface finish
<b>120x278 cm</b> - 47 <sup>1</sup> / <sub>4</sub> "x109 <sup>1</sup> / <sub>2</sub> " A4VK Dusk <sup>(4)</sup>	± 6 mm	Matte



Sizes	Thickness	Surface finish
<b>120x278 cm</b> - 47 <sup>1</sup> / <sub>4</sub> "x109 <sup>1</sup> / <sub>2</sub> " A4VL Midnight <sup>(4)</sup>	± 6 mm	Matte



Sizes	Thickness	Surface finish
<b>120x278 cm</b> - 47 <sup>1</sup> / <sub>4</sub> "x109 <sup>1</sup> / <sub>2</sub> " A4VM Moss <sup>(4)</sup>	± 6 mm	Matte



Sizes	Thickness	Surface finish
<b>120x278 cm</b> - 47 <sup>1</sup> / <sub>4</sub> "x109 <sup>1</sup> / <sub>2</sub> " A4VN Emerald <sup>(4)</sup>	± 6 mm	Matte

Large Sizes



Color & Decor

INDEX



A COMPLETE PRODUCT SYSTEM >

PRODUCT FINDER >

SURFACE RANGE >

COMPANY >

COLLECTIONS >

LARGE SIZES >

MARBLE LOOK  
METAL LOOK  
CONCRETE LOOK  
STONE LOOK  
COLOR & DECOR LOOK

NOTES

SLABS FOR COUNTERTOPS & FURNITURE >

SINKS & BATHROOM FURNISHING >

FACADES >

TECHNICAL SPECIFICATIONS >

<sup>(1)</sup> The various graphics of the product are distributed randomly in the boxes, without the possibility of choosing between the available patterns.

<sup>(4)</sup> The use of a common mild detergent is recommended. Avoid using acidic or alkaline products, waxes, steel wool, or abrasives.

The decoration can only be laid on the wall (translations: page 401)

COMPLETE YOUR PROJECT



Sinks  
P.412

# Large Sizes<sup>(1)</sup>

## Glazed Porcelain Tiles



PRISM  
BRUSH

**Sizes**                      **Thickness**   **Surface finish**

**120x278 cm** - 47<sup>1</sup>/<sub>4</sub>"x109<sup>1</sup>/<sub>2</sub>"    ± 6 mm    Matte  
A4VP Brush XL<sup>(4)</sup>



PRISM  
GRADIENT

**Sizes**                      **Thickness**   **Surface finish**

**120x278 cm** - 47<sup>1</sup>/<sub>4</sub>"x109<sup>1</sup>/<sub>2</sub>"    ± 6 mm    Matte  
A4VO Gradient XL<sup>(4)</sup>



BOOST PRO  
LEAVES

**Sizes**                      **Thickness**   **Surface finish**

**120x278 cm** - 47<sup>1</sup>/<sub>4</sub>"x109<sup>1</sup>/<sub>2</sub>"    ± 6 mm    Matte  
A3HE Leaves A<sup>(4) (5)</sup>  
A3M2 Leaves B<sup>(4) (5)</sup>

**PATTERNS**



**PATTERNS**



**PATTERNS**



A

B

<sup>(1)</sup> The various graphics of the product are distributed randomly in the boxes, without the possibility of choosing between the available patterns.  
<sup>(4)</sup> The use of a common mild detergent is recommended. Avoid using acidic or alkaline products, waxes, steel wool, or abrasives.

<sup>(5)</sup> Codes A and B are sold separately.

The decoration can only be laid on the wall

(translations: page 401)

## Porcelain Tiles



BOOST PRO  
GROVE

**Sizes**                      **Thickness**   **Surface finish**

**120x278 cm** - 47<sup>1</sup>/<sub>4</sub>"x109<sup>1</sup>/<sub>2</sub>"    ± 6 mm    Matte  
AØLW Grove

**PATTERNS**

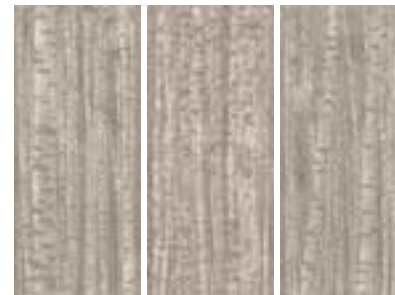

BOOST PRO  
PAINT

**Sizes**                      **Thickness**   **Surface finish**

**120x278 cm** - 47<sup>1</sup>/<sub>4</sub>"x109<sup>1</sup>/<sub>2</sub>"    ± 6 mm    Matte  
AØLX Paint

**PATTERNS**

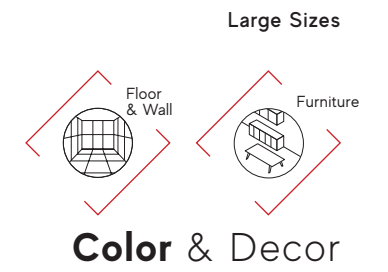

INDEX



A COMPLETE  
PRODUCT  
SYSTEM



PRODUCT  
FINDER



SURFACE  
RANGE



COMPANY



COLLECTIONS



LARGE SIZES



MARBLE LOOK  
METAL LOOK  
CONCRETE LOOK  
STONE LOOK  
COLOR & DECOR LOOK

NOTES

SLABS FOR  
COUNTERTOPS  
& FURNITURE



SINKS &  
BATHROOM  
FURNISHING



FACADES



TECHNICAL  
SPECIFICATIONS



COMPLETE YOUR PROJECT



Sinks  
P.412

# MARBLE LOOK



Marvel Calacatta Prestigio, Marvel Calacatta Delicato, Marvel Statuario Supremo, Marvel Calacatta Imperiale, Marvel Calacatta Apuano, Marvel Carrara Pure, Marvel Calacatta Sublime, Calacatta Borghini, Marvel Bianco Dolomite, Marvel Crema Delicato, Marvel Calacatta Extra, Marvel Statuario Select, Marvel Royal Calacatta, Marvel Bianco Fantastico, Marvel Travertine White Vein, Marvel Travertine White Cross, Marvel Travertine Sand Vein, Marvel Travertine Sand Cross, Cream Prestige, Marvel Travertine Pearl Vein, Marvel Travertine Pearl Cross, Marvel Elegant Sable



Floor & Wall Furniture

160x320 cm 63"x126"	± 6 mm	Polished		Polished						Polished	Polished	Polished Matte											
160x160 cm 63"x63"	± 6 mm	Polished		Polished						Polished	Polished	Polished Matte											
120x278 cm 47 1/4"x109 1/2"	± 6 mm	Polished Silk	Polished	Polished Silk	Polished	Polished Silk	Polished Matte	Polished Silk		Polished Matte	Polished Matte	Polished Matte	Polished	Polished	Polished Matte	Matte		Matte			Matte		
120x240 cm 47 1/4"x94 1/2"	± 9 mm	Polished	Polished	Polished	Polished	Polished	Polished	Polished		Polished	Polished	Polished	Polished	Polished	Polished	Matte		Matte			Matte		
120x120 cm 47 1/4"x47 1/4"	± 9 mm	Polished Matte (S)	Polished Matte (S)	Polished Matte (S)	Polished Matte (S)	Polished Silk	Polished Matte (S)	Polished Silk		Polished Matte (S)	Polished Matte (S)	Polished Matte (S)	Polished	Polished	Polished Matte (S)		Matte (S)		Matte (S)			Matte (S)	Polished



Countertops Furniture

162x324 cm 63 3/4"x127 1/2"	± 6 mm				Silk																	Polished Silk			Hammered				
Non-rectified / non rettificato	± 12 mm	Silk	Silk	Satin Silk	Polished Satin Silk	Polished Silk			Polished Silk	Polished			Polished Silk												Hammered		Silk	Hammered	
159x324 cm 62 5/8"x127 1/2"	± 20 mm			Polished Matte	Polished Matte																								
Non-rectified / non rettificato									Polished Matte	Polished			Polished Matte																



- MARBLE LOOK
- METAL LOOK
- CONCRETE LOOK
- STONE LOOK
- COLOR & DECOR LOOK
- NOTES



## MARBLE LOOK

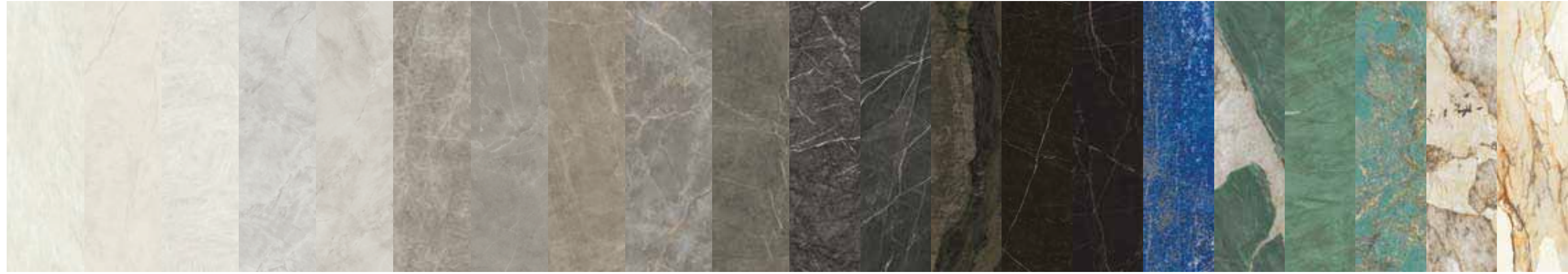

Marvel Imperial White, Marvel Calacatta Perla, Marvel Crystal White, Marvel Grey Cloud, White Cloud, Light Grey Stone, Marvel Grey Fleury, Marvel Gris Supreme, Marvel Fiori di Bosco, Marvel Grey Stone, Marvel Grigio Intenso, Marvel Calacatta Black, Marvel Absolute Brown, Nero Marquina, Marvel Black Atlantis, Marvel Ultramarine, Exotic Wave, Marvel Exotic Green, Marvel Amazonite, Marvel Desert Soul, Calacatta Antique



Floor & Wall



Furniture

160x320 cm 63"x126"	± 6 mm																				
160x160 cm 63"x63"	± 6 mm																				
120x278 cm 47 1/4"x109 1/2"	± 6 mm		Polished Silk	Polished	Polished Silk			Polished Matte		Polished Silk	Polished Matte	Polished	Polished	Polished		Polished Matte	Polished		Polished	Polished	Polished
120x240 cm 47 1/4"x94 1/2"	± 9 mm		Polished		Polished					Polished	Polished	Polished				Polished					
120x120 cm 47 1/4"x47 1/4"	± 9 mm	Polished	Polished Silk	Polished	Polished Silk			Polished Matte (S)	Polished	Polished Silk	Polished Matte (S)	Polished	Polished	Polished			Polished	Polished	Polished		



Countertops



Furniture

162x324 cm 63 3/4"x127 1/2" Non-rectified / non rettificato	± 6 mm			Polished																	Polished		
	± 12 mm			Polished Silk		Silk	Silk									Polished Satin Silk	Polished Silk		Polished	Polished		Polished Silk	Polished
	± 20 mm															Matte							Polished
159x324 cm 62 5/8"x127 1/2" Non-rectified / non rettificato	± 20 mm			Polished																			

INDEX

A COMPLETE PRODUCT SYSTEM

PRODUCT FINDER

SURFACE RANGE

COMPANY

COLLECTIONS

LARGE SIZES

- MARBLE LOOK
- METAL LOOK
- CONCRETE LOOK
- STONE LOOK
- COLOR & DECOR LOOK
- NOTES

SLABS FOR COUNTERTOPS & FURNITURE

SINKS & BATHROOM FURNISHING

FACADES

TECHNICAL SPECIFICATIONS

## CONCRETE & RESIN LOOK



Prism Cotton Boost Pro Ivory Boost Natural Kaolin Dwell Off White Boost White Prism Cord Boost Pro Cream Prism Cloud Boost Pearl Boost Natural Ash Boost Pro Clay Boost Natural Coral Boost Natural Ecru Dwell Greige Prism Suede Boost Pro Taupe Dwell Gray Boost Grey Prism Fog Boost Smoke Dwell Smoke Boost Natural Coal Boost Natural Umber Boost Pro Tobacco Boost Tarmac Prism Graphite

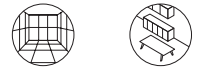

Floor & Wall Furniture

160x320 cm 63"x126"	± 6 mm																										Hammered															Hammered															Hammered															Hammered
160x160 cm 63"x63"	± 6 mm																										Matte															Matte														Matte																
120x278 cm 47 1/4"x109 1/2"	± 6 mm	Matte	Matte	Matte																						Matte	Matte	Matte	Matte	Matte	Matte	Matte	Matte	Matte	Matte	Matte	Matte	Matte	Matte	Matte	Matte	Matte	Matte	Matte	Matte	Matte	Matte	Matte	Matte	Matte	Matte	Matte	Matte	Matte	Matte	Matte	Matte	Matte														
120x240 cm 47 1/4"x94 1/2"	± 9 mm		Matte																							Matte	Matte														Matte	Matte													Matte	Matte																
120x120 cm 47 1/4"x47 1/4"	± 6 mm		Matte																							Matte	Matte														Matte	Matte												Matte	Matte																	
	± 9 mm	Matte (S) Silk	Matte (S)	Matte (S)	Matte	Matte (S)	Matte (S) Silk	Matte (S)	Matte (S)	Matte (S) Silk	Matte (S)	Matte (S)	Matte (S)	Matte (S)	Matte	Matte (S) Silk	Matte (S)	Matte	Matte (S)	Matte (S) Silk	Matte (S)	Matte	Matte (S)	Matte (S)	Matte (S)	Matte	Matte (S) Silk	Matte (S)	Matte (S)	Matte (S)	Matte (S)	Matte (S)	Matte (S)	Matte (S)	Matte (S)	Matte (S)	Matte (S)	Matte (S)	Matte (S) Silk																																	



Outdoor

120x120 cm 47 1/4"x47 1/4"	± 9 mm		Grip	Grip																						Grip	Grip	Grip	Grip	Grip	Grip	Grip	Grip	Grip	Grip	Grip	Grip	Grip	Grip	Grip	Grip	Grip	Grip	Grip	Grip	Grip	Grip	
120x240 cm 47 1/4"x94 1/2"	± 20 mm																									Outdoor																						Outdoor
120x120 cm 47 1/4"x47 1/4"	± 20 mm			Outdoor																						Outdoor	Outdoor	Outdoor	Outdoor	Outdoor	Outdoor	Outdoor	Outdoor	Outdoor	Outdoor	Outdoor	Outdoor	Outdoor	Outdoor	Outdoor	Outdoor	Outdoor	Outdoor	Outdoor	Outdoor	Outdoor	Outdoor	Outdoor



Countertops Furniture

162x324 cm 63 3/4"x127 1/2"	± 12 mm																									Hammered																						Hammered														Hammered														Hammered																																			
Non-rectified / non rettificato	± 20 mm																																																																																																														

- INDEX
- A COMPLETE PRODUCT SYSTEM
- PRODUCT FINDER
- SURFACE RANGE
- COMPANY
- COLLECTIONS
- LARGE SIZES
- MARBLE LOOK  
METAL LOOK  
CONCRETE LOOK  
STONE LOOK  
COLOR & DECOR LOOK  
NOTES
- SLABS FOR COUNTERTOPS & FURNITURE
- SINKS & BATHROOM FURNISHING
- FACADES
- TECHNICAL SPECIFICATIONS



STONE LOOK



Lims Ivory Kone Gypsum Kone White Boost Stone Ivory Boost Stone White Boost Mix Ivory Boost Stone Cream Lims Grey Lims Beige Lims Desert Boost Stone Clay Boost Stone Taupe MS. Clauzetto White Boost Stone Pearl Boost Mix Pearl Kone Pearl Kone Mix Boost Stone Grey Kone Grey Boost Stone Smoke Dolmen Pro Grigio MS. Cardoso Elegant Boost Mix Smoke Boost Stone Tobacco MS. Balsatina Volcano Soapstone Dark Boost Stone Tarmac



Floor & Wall Furniture

120x278 cm 47 1/4"x109 1/2"	± 6 mm	Matte			Matte	Matte	Matte	Matte	Matte	Matte	Matte	Matte		Matte	Matte			Matte		Matte		Matte	Matte			Matte
120x240 cm 47 1/4"x94 1/2"	± 9 mm												Matte								Matte			Matte		
120x120 cm 47 1/4"x47 1/4"	± 9 mm	Matte (S)		Matte (S)	Matte (S)	Matte (S)	Matte (S)	Matte (S)	Matte (S)	Matte (S)	Matte (S)	Matte (S)	Matte (S)	Matte (S)	Matte (S)	Matte (S)	Matte (S)	Matte (S)	Matte (S)	Matte (S)	Matte (S)	Matte (S)	Matte (S)	Matte (S)	Matte (S)	Matte (S)



Outdoor

120x120 cm 47 1/4"x47 1/4"	± 20 mm				Outdoor	Outdoor	Outdoor				Outdoor				Outdoor			Outdoor		Outdoor				Outdoor		Outdoor
-------------------------------	---------	--	--	--	---------	---------	---------	--	--	--	---------	--	--	--	---------	--	--	---------	--	---------	--	--	--	---------	--	---------



Countertops Furniture

162x324 cm 63 3/4"x127 1/2"	± 6 mm														Hammered									Hammered		
Non-rectified / non rettificato	± 12 mm		Hammered		Hammered										Hammered					Flamed				Hammered	Hammered	
	± 20 mm																							Hammered	Hammered	



A COMPLETE PRODUCT SYSTEM >

PRODUCT FINDER >

SURFACE RANGE >

COMPANY >

COLLECTIONS >

LARGE SIZES >

- MARBLE LOOK
- METAL LOOK
- CONCRETE LOOK
- STONE LOOK
- COLOR & DECOR LOOK
- NOTES

SLABS FOR COUNTERTOPS & FURNITURE >

SINKS & BATHROOM FURNISHING >

FACADES >

TECHNICAL SPECIFICATIONS >

METAL LOOK

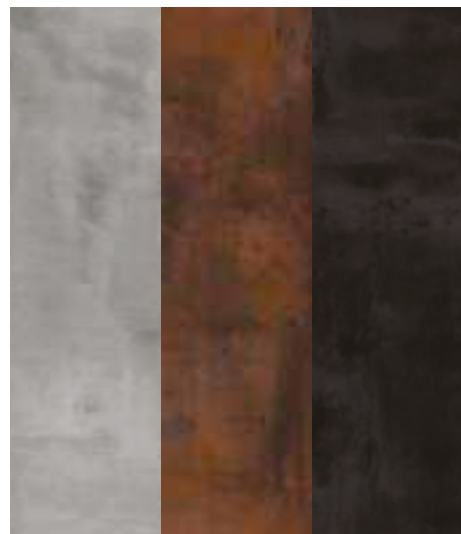

Blaze Aluminium  
Blaze Corten  
Blaze Iron

SOLID LOOK



Absolute White  
Absolute Black  
Black Lava

COLOR LOOK

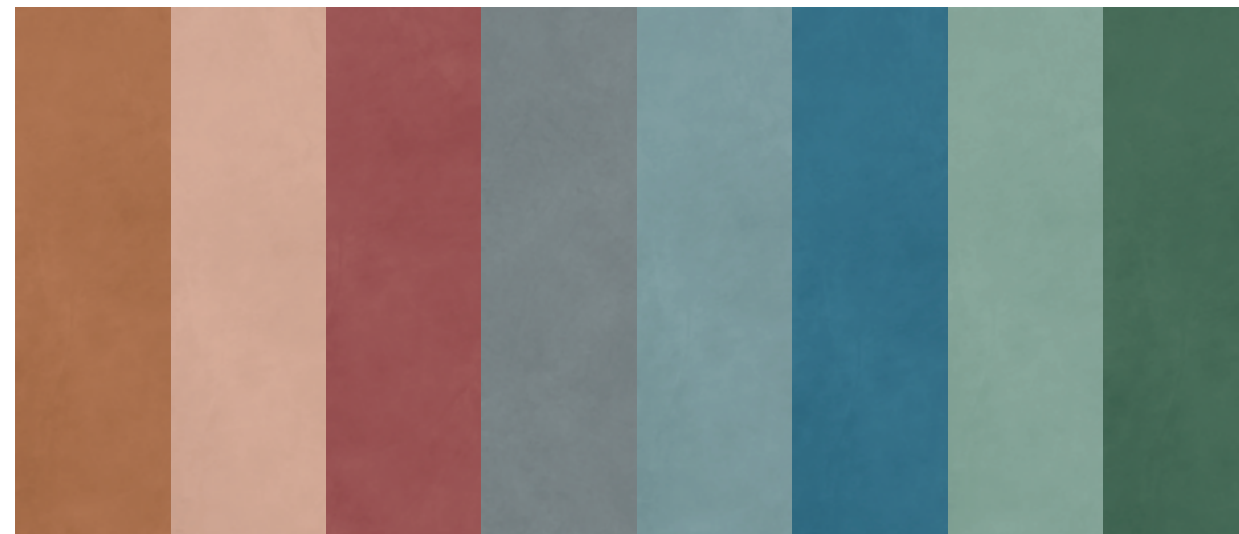

Prism Caramel  
Prism Bloom  
Prism Grape  
Boost Natural Cobalt  
Prism Dusk  
Prism Midnight  
Prism Moss  
Prism Emerald



Floor & Wall



Furniture

120x278 cm 47 <sup>1</sup> / <sub>4</sub> "x109 <sup>1</sup> / <sub>2</sub> "	± 6 mm	Matte	Matte	Matte
120x120 cm 47 <sup>1</sup> / <sub>4</sub> "x47 <sup>1</sup> / <sub>4</sub> "	± 9 mm	Matte	Matte	Matte



Outdoor

120x120 cm 47 <sup>1</sup> / <sub>4</sub> "x47 <sup>1</sup> / <sub>4</sub> "	± 20 mm		Outdoor	
---	---------	--	---------	--



Countertops



Furniture

162x324 cm 63 <sup>3</sup> / <sub>4</sub> "x127 <sup>1</sup> / <sub>2</sub> "	± 6 mm			
Non-rectified / non rettificato	± 12 mm		Matte	



Countertop



Furniture

162x324 cm 63 <sup>3</sup> / <sub>4</sub> "x127 <sup>1</sup> / <sub>2</sub> " Non-rectified / non rettificato	± 6 mm	Matte		
	± 12 mm	Polished Matte	Matte	Leathered
	± 20 mm			Leathered
159x324 cm 62 <sup>5</sup> / <sub>8</sub> "x127 <sup>1</sup> / <sub>2</sub> " Non-rectified / non rettificato	± 20 mm	Polished Matte		



Floor & Wall



Furniture

120x278 cm 47 <sup>1</sup> / <sub>4</sub> "x109 <sup>1</sup> / <sub>2</sub> "	± 6 mm	Matte	Matte	Matte	Matte	Matte	Matte	Matte
120x120 cm 47 <sup>1</sup> / <sub>4</sub> "x47 <sup>1</sup> / <sub>4</sub> "	± 9 mm				Matte (S)			

<sup>(1)</sup> The various graphics of the product are distributed randomly in the boxes, without the possibility of choosing between the available patterns. - All'interno delle casse, le varie grafiche del prodotto sono distribuite in modo casuale, senza possibilità di scelta tra i pattern disponibili. - A l'intérieur delle caisses, les différents graphismes du produit sont distribués en mode aléatoire, sans possibilité de choix entre les motifs disponibles. - Die Kästen enthalten die verschiedenen Grafiken des Artikels nach dem Zufallsprinzip, ohne dass Sie zwischen den einzelnen Motiven wählen können. - En el interior de las cajas, los distintos gráficos de los productos se distribuyen de forma aleatoria, sin que se pueda elegir el patrón disponible. - Рисунки распределены в ящиках в случайном порядке, без возможности выбора из доступных рисунков.

<sup>(2)</sup> The Endless Kit contains all the graphics of the product with vein continuity, ensuring that all the numbered faces in the composition can be found in a single box. The number of the graphic - G1, G2, G3, etc - is printed on the side and indicated with an adhesive label placed on the slab. To reconstruct the surface with continuous veins, simply lay the tiles in numerical progression: G1, G2, G3 and so on. - Il Kit Endless contiene tutte le grafiche del prodotto con continuità di vena, garantisce in un'unica cassa tutto le facce numerate che creano la composizione. Il numero della grafica, indicato come G1, G2, G3, ecc. viene stampato sulla costa del lato 278 e indicato con un adesivo posto sulla lastra. Per ricostruire la superficie con continuità di vena è sufficiente posare le lastre in progressione numerica: G1, G2, G3, ecc. - Le Kit Endless contient tous les graphismes du produit avec la continuité des veines; il garantit, dans une seule caisse, toutes les faces numérotées qui créent la composition. Le numéro du graphisme, indiqué comme G1, G2, G3, etc. est imprimé sur le bord du côté 278 et indiqué avec un adhésif apposé sur la dalle. Pour reconstruire la surface avec les veines en continuité, il suffit de poser les dalles en progression numérique: G1, G2, G3, etc. - Kit Endless umfasst alle Grafiken des Produkts mit durchlaufender Aderung und damit alle nummerierten Oberflächen, aus denen sich die Komposition zusammensetzt, garantiert in einer einzigen Kiste. Die Nummer der Grafik, d.h. G1, G2, G3 etc., ist auf der Kante der 278 cm langen Seite aufgedruckt und auch mit einem Klebeetikett auf der Platte angegeben. Um das Gesamtbild mit durchlaufender Aderung zusammensetzen, werden die Platten einfach in numerischer Reihenfolge verlegt. G1, G2, G3 usw. - El Kit Endless contiene todas las caras del producto con continuidad de vetas, garantiza contar en una sola caja con todas las caras numeradas que forman la composición. El número del gráfico, indicado como G1, G2, G3, etc., está impreso en el borde del lado 278 y se indica mediante un adhesivo en la losa. Para reconstruir la superficie con continuidad de vetas, basta con colocar las losas en progresión numérica: G1, G2, G3, etc. - Kit Endless - это комплект, который содержит все плиты, необходимые для составления композиции с непрерывным рисунком прожилок. Все плиты пронумерованы и находятся в одном ящике. Номер плиты, обозначенный как G1, G2, G3 и т.д., напечатан на торце грани 278 и указан также на наклейке в углу плиты. Чтобы при облицовке создать рисунок с непрерывающимися прожилками, необходимо просто уложить плиты в последовательности: G1, G2, G3 и т.д.

<sup>(3)</sup> Minor misalignments in the continuity of the veins between different graphics is normal for this type of product. - Eventuali piccoli disallineamenti nella continuità delle venature tra grafiche diverse sono una caratteristica intrinseca di questa tipologia di prodotto. - Les éventuels petits désalignements de la continuité des veines entre différents graphismes sont une caractéristique intrinsèque de cette typologie de produit. - Eventuelle kleine Versätze im Verlauf der Aderungen zwischen unterschiedlichen Grafiken sind charakteristisch für dieses Produkt. - Cualquier pequeño desalineado en la continuidad de las vetas entre diferentes gráficos es una característica intrínseca de este tipo de productos. - Возможные небольшие смещения рисунка прожилок на стыке плит являются характеристикой данного вида изделий.

<sup>(4)</sup> Calacatta Extra Endless is composed of four graphics with vein continuity, but are distributed randomly in the boxes, without the possibility of choosing between the available patterns. - Calacatta Extra Endless è composto da quattro grafiche con continuità di vena, ma all'interno delle casse queste sono distribuite in modo casuale, senza possibilità di scelta tra i pattern disponibili. - Calacatta Extra Endless est composé de quatre graphismes avec les veines en continuité, mais celles-ci sont distribuées en mode aléatoire à l'intérieur delle caisses, sans possibilité de choix entre les motifs disponibles. - Calacatta Extra Endless besteht aus vier Grafiken mit durchlaufender Aderung, diese sind jedoch in den Kästen nach dem Zufallsprinzip enthalten, ohne dass Sie zwischen den einzelnen Motiven wählen können. - Calacatta Extra Endless se compone de cuatro gráficos con continuidad de vetas, pero en el interior de las cajas están distribuidos de forma aleatoria, sin que se pueda elegir el patrón disponible. - Calacatta Extra Endless состоит из четырех рисунков с непрерывными прожилками, но они распределены в ящиках в случайном порядке, без возможности выбора из доступных рисунков.

<sup>(5)</sup> The use of a common mild detergent is recommended. Avoid using acidic or alkaline products, waxes, steel wool, or abrasives. - Si consiglia l'utilizzo di un comune detergente neutro. Evitare l'utilizzo di prodotti acidi o alcalini, ceranti, pagliette di metallo o abrasive. - Nous vous conseillons d'utiliser des détergents neutres courants. Éviter l'utilisation de cires et de produits acides ou alcalins, ainsi que les pailles métalliques ou abrasives. - Es empfiehlt sich, ein haushaltsübliches, neutrales Reinigungsmittel zu verwenden. Saure oder alkalische Produkte, Wachs sowie Metallwolle- bzw. Scheuerschwämme sind zu vermeiden. - Recomendamos utilizar un detergente neutro común. Hay que evitar el uso de productos ácidos o alcalinos, ceras y estropajos de metal o abrasivos. - екомендуется чистить обычным нейтральным моющим средством. Не рекомендуется использовать кислотные, щелочные, восковые средства, а также металлические мочалки.

<sup>(6)</sup> Codes A and B are sold separately. - I codici A e B sono venduti singolarmente. - Les codes A et B sont vendus individuellement. - Die Codes A und B sind einzeln erhältlich. - Los códigos A y B se venden individualmente. - Коды А и В продаются по отдельности.

<sup>(7)</sup> The decoration can only be laid on the wall - Il decoro si può posare solo a rivestimento - Décor uniquement mural - Das Dekor kann nur an der Wand verlegt werden - La decoración se puede colocar únicamente en paredes - Декор может быть уложен только на стену.

- INDEX ≡
- A COMPLETE PRODUCT SYSTEM >
- PRODUCT FINDER >
- SURFACE RANGE >
- COMPANY >
- COLLECTIONS >
- LARGE SIZES >
- MARBLE LOOK  
METAL LOOK  
CONCRETE LOOK  
STONE LOOK  
COLOR & DECOR LOOK
- NOTES
- SLABS FOR COUNTERTOPS & FURNITURE >
- SINKS & BATHROOM FURNISHING >
- FACADES >
- TECHNICAL SPECIFICATIONS >



atlasconcorde.com >  
ATLAS PLAN

© Ceramiche Atlas Concorde

atlasPLAN

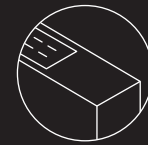

Countertops



Furniture

# Slabs for Countertops & Furniture



162x324 ± 6-12-20 mm  
SINGLE SLAB NON-RECTIFIED



159x324 ± 20 mm  
SINGLE SLAB NON-RECTIFIED

- ↔ MARBLE LOOK
- ↔ STONE LOOK
- ↔ CONCRETE LOOK
- ↔ SOLID LOOK
- ↔ METAL LOOK

↔ NOTES

INDEX



A COMPLETE  
PRODUCT  
SYSTEM >

PRODUCT  
FINDER >

SURFACE  
RANGE >

COMPANY >

COLLECTIONS >

LARGE SIZES >

SLABS FOR  
COUNTERTOPS  
& FURNITURE >

MARBLE LOOK  
STONE LOOK  
CONCRETE LOOK  
SOLID LOOK  
METAL LOOK  
NOTES

SINKS &  
BATHROOM  
FURNISHING >

FACADES >

TECHNICAL  
SPECIFICATIONS >

# Slabs for Countertops & Furniture

## Marble Look

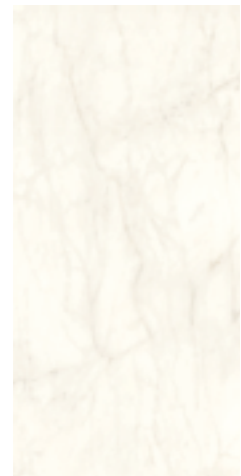

**CALACATTA DELICATO**  
**162x324 cm** - 63<sup>3</sup>/<sub>4</sub>"x127<sup>1</sup>/<sub>2</sub>"  
 ± 12 mm ST \*

A4T3 Calacatta Delicato Silk

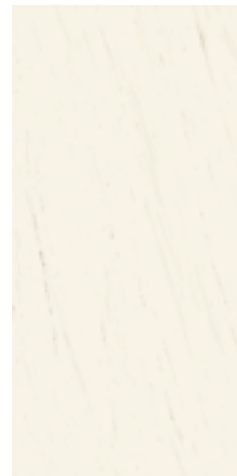

**BIANCO DOLOMITE**  
**162x324 cm** - 63<sup>3</sup>/<sub>4</sub>"x127<sup>1</sup>/<sub>2</sub>"  
 ± 12 mm ST \*

AAVG B. Dolomite Polished

**159x324 cm** - 62<sup>5</sup>/<sub>8</sub>"x127<sup>1</sup>/<sub>2</sub>"  
 ± 20 mm

AILN B. Dolomite Polished



**CALACATTA APUANO** Bookmatch  
**162x324 cm** - 63<sup>3</sup>/<sub>4</sub>"x127<sup>1</sup>/<sub>2</sub>"  
 ± 12 mm ST \*

AGRP Calacatta Apuano Polished  
 AGRQ Calacatta Apuano Bookmatch Polished  
 AGRJ Calacatta Apuano Silk  
 AGRL Calacatta Apuano Bookmatch Silk

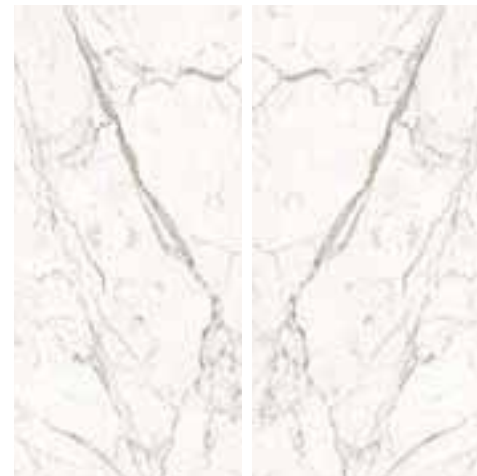

**STATUARIO SUPREMO** Bookmatch  
**162x324 cm** - 63<sup>3</sup>/<sub>4</sub>"x127<sup>1</sup>/<sub>2</sub>"  
 ± 12 mm ST \*

A4TX Statuario Supremo Silk  
 A4TY Statuario Supremo Bookmatch Silk  
 A4I3 Statuario Supremo Satin  
 A4I5 Statuario Supremo Bookmatch Satin

**159x324 cm** - 62<sup>5</sup>/<sub>8</sub>"x127<sup>1</sup>/<sub>2</sub>"  
 ± 20 mm

AILO Statuario Supremo Polished <sup>(1)</sup>  
 AIRT Statuario Supremo Matte <sup>(1)</sup>



**162x324 cm** - 63<sup>3</sup>/<sub>4</sub>"x127<sup>1</sup>/<sub>2</sub>" Non-Rectified ± 6-12-20 mm

**159x324 cm** - 62<sup>5</sup>/<sub>8</sub>"x127<sup>1</sup>/<sub>2</sub>" Non-Rectified ± 20 mm

atlasPLAN

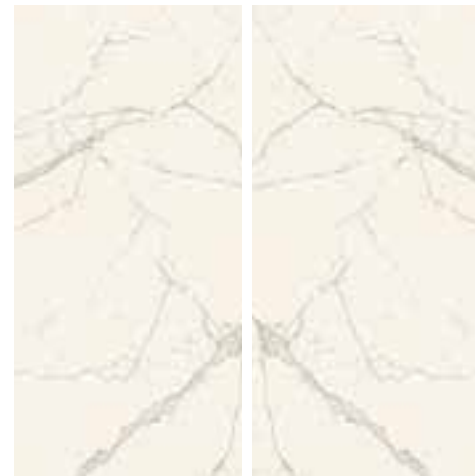
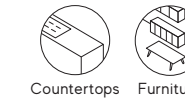

**CALACATTA EXTRA** Bookmatch  
**162x324 cm** - 63<sup>3</sup>/<sub>4</sub>"x127<sup>1</sup>/<sub>2</sub>"  
 ± 6 mm ST \*

ANIJ C. Extra A Polished  
 AOAZ C. Extra A Bookmatch Polished  
 ANIG C. Extra A Silk  
 AOAW C. Extra A Bookmatch Silk

± 12 mm ST \*

AAVD C. Extra A Polished  
 AA2X C. Extra A Bookmatch Polished  
 AA2T C. Extra A Silk  
 AMJV C. Extra A Bookmatch Silk

**159x324 cm** - 62<sup>5</sup>/<sub>8</sub>"x127<sup>1</sup>/<sub>2</sub>"  
 ± 20 mm

AIRN C. Extra A Polished  
 AIRP C. Extra A Bookmatch Polished  
 AIRQ C. Extra A Matte  
 AIRR C. Extra A Bookmatch Matte  
 AIRM C. Extra A Polished <sup>(1)</sup>  
 AILQ C. Extra A Matte <sup>(1)</sup>

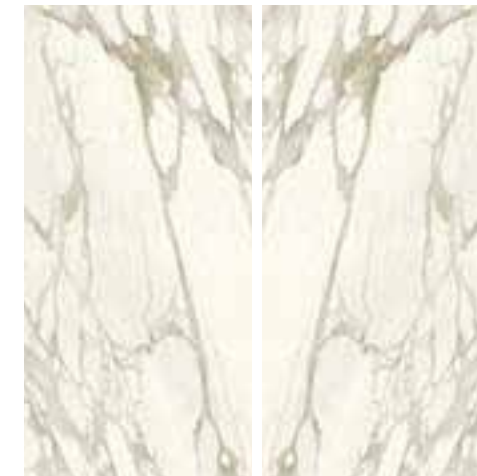

**CALACATTA BORGHINI** Bookmatch  
**162x324 cm** - 63<sup>3</sup>/<sub>4</sub>"x127<sup>1</sup>/<sub>2</sub>"  
 ± 12 mm ST \*

AF5B Calacatta Borghini Silk  
 AF5C Calacatta Borghini Bookmatch Silk  
 AF5E Calacatta Borghini Polished  
 AF5K Calacatta Borghini Bookmatch Polished

**159x324 cm** - 62<sup>5</sup>/<sub>8</sub>"x127<sup>1</sup>/<sub>2</sub>"  
 ± 20 mm

AIRK Calacatta Borghini Polished <sup>(1)</sup>  
 AIRL Calacatta Borghini Matte <sup>(1)</sup>

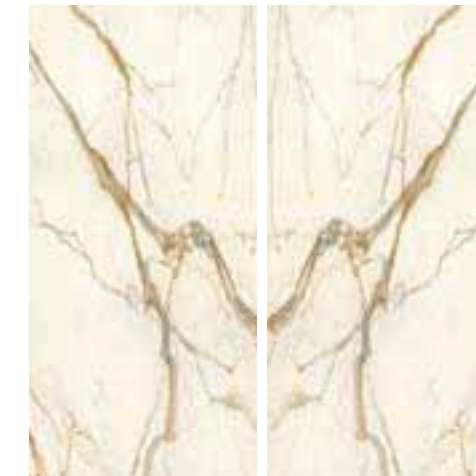

**CALACATTA IMPERIALE** Bookmatch  
**162x324 cm** - 63<sup>3</sup>/<sub>4</sub>"x127<sup>1</sup>/<sub>2</sub>"  
 ± 6 mm ST \*

A2YG Calacatta Imperiale Silk  
 A2YH Calacatta Imperiale Bookmatch Silk

± 12 mm ST \*

AØXI Calacatta Imperiale Polished  
 AØXT Calacatta Imperiale Bookmatch Polished  
 A3M9 Calacatta Imperiale Satin  
 A4I1 Calacatta Imperiale Bookmatch Satin  
 AØXV Calacatta Imperiale Silk  
 AØXX Calacatta Imperiale Bookmatch Silk

**159x324 cm** - 62<sup>5</sup>/<sub>8</sub>"x127<sup>1</sup>/<sub>2</sub>"  
 ± 20 mm

AIRS Calacatta Imperiale Polished <sup>(1)</sup>  
 AILP Calacatta Imperiale Matte <sup>(1)</sup>



**CALACATTA PRESTIGIO** Bookmatch  
**162x324 cm** - 63<sup>3</sup>/<sub>4</sub>"x127<sup>1</sup>/<sub>2</sub>"  
 ± 12 mm ST \*

A4TØ Calacatta Prestigio Silk  
 A4T1 Calacatta Prestigio Bookmatch Silk

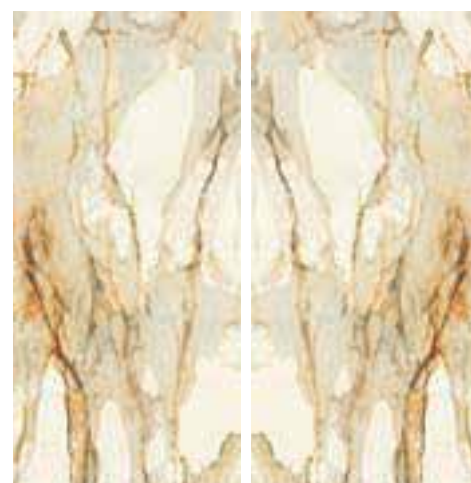

**CALACATTA ANTIQUE** Bookmatch  
**162x324 cm** - 63<sup>3</sup>/<sub>4</sub>"x127<sup>1</sup>/<sub>2</sub>"  
 ± 12 mm ST \*

AØXZ C. Calacatta Antique Polished  
 A8T7 Calacatta Antique Bookmatch Polished



**TRAVERTINO SAND**  
**162x324 cm** - 63<sup>3</sup>/<sub>4</sub>"x127<sup>1</sup>/<sub>2</sub>"  
 ± 6 mm ST \*

A8VL T. Sand Hammered

± 12 mm ST \*

A647 T. Sand Hammered

**TRAVERTINO PEARL**  
**162x324 cm** - 63<sup>3</sup>/<sub>4</sub>"x127<sup>1</sup>/<sub>2</sub>"  
 ± 12 mm ST \*

AF4Z T. Pearl Hammered

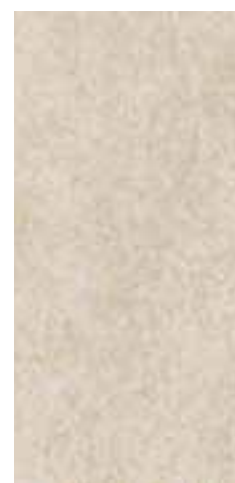

**CREAM PRESTIGE**  
**162x324 cm** - 63<sup>3</sup>/<sub>4</sub>"x127<sup>1</sup>/<sub>2</sub>"  
 ± 12 mm ST \*

AAV6 Cream Prestige Silk

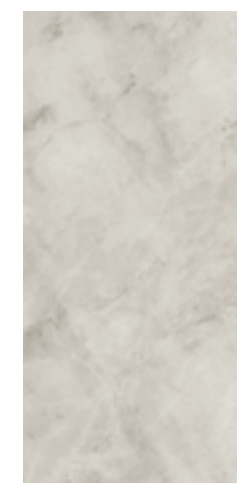

**WHITE CLOUD**  
**162x324 cm** - 63<sup>3</sup>/<sub>4</sub>"x127<sup>1</sup>/<sub>2</sub>"  
 ± 12 mm ST \*

A4UO White Cloud Silk

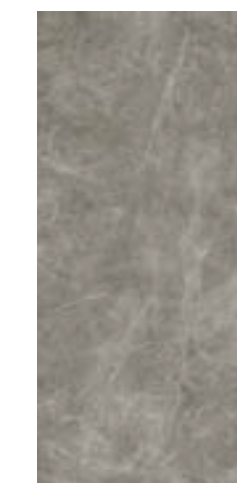

**LIGHT GREY STONE**  
**162x324 cm** - 63<sup>3</sup>/<sub>4</sub>"x127<sup>1</sup>/<sub>2</sub>"  
 ± 12 mm ST \*

AMJ9 Light Grey Silk

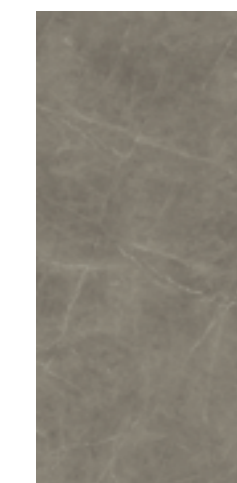

**GREY STONE**  
**162x324 cm** - 63<sup>3</sup>/<sub>4</sub>"x127<sup>1</sup>/<sub>2</sub>"  
 ± 6 mm ST \*

ANIV Grey Stone Silk

± 12 mm ST \*

AAWA Grey Stone Silk

± 20 mm

AHH2 Grey Stone Matte

\* With fiberglass mesh



A COMPLETE PRODUCT SYSTEM >

PRODUCT FINDER >

SURFACE RANGE >

COMPANY >

COLLECTIONS >

LARGE SIZES >

SLABS FOR COUNTERTOPS & FURNITURE >

MARBLE LOOK  
 STONE LOOK  
 CONCRETE LOOK  
 SOLID LOOK  
 METAL LOOK  
 NOTES

SINKS & BATHROOM FURNISHING >

FACADES >

TECHNICAL SPECIFICATIONS >

# Slabs for Countertops & Furniture



## Marble Look



**NERO MARQUINA** Bookmatch  
**162x324 cm** - 63<sup>3</sup>/<sub>4</sub>"x127<sup>1</sup>/<sub>2</sub>"  
 ± 6 mm ST \*  
 A07Y Nero Marquina Silk  
 ± 12 mm ST \*  
 ANWA Nero Marquina Polished  
 A6T5 Nero Marquina Bookmatch Polished  
 ANVK Nero Marquina Silk  
 A6T4 Nero Marquina Bookmatch Silk  
 A3M5 Nero Marquina Satin  
 A6T6 Nero Marquina Bookmatch Satin  
 ± 20 mm  
 AHH5 Nero Marquina Matte



**BLACK ATLANTIS** Bookmatch  
**162x324 cm** - 63<sup>3</sup>/<sub>4</sub>"x127<sup>1</sup>/<sub>2</sub>"  
 ± 12 mm ST \*  
 A9CK Black Atlantis Polished  
 A9CL Black Atlantis Bookmatch Polished  
 A8XV Black Atlantis Silk  
 A8XW Black Atlantis Bookmatch Silk



**CRYSTAL WHITE** Bookmatch  
**162x324 cm** - 63<sup>3</sup>/<sub>4</sub>"x127<sup>1</sup>/<sub>2</sub>"  
 ± 6 mm ST \*  
 AGRH Crystal White Polished  
 AGRF Crystal White Bookmatch Polished  
 ± 12 mm ST \*  
 A9C2 Crystal White Polished  
 AF2W Crystal White Bookmatch Polished  
 A9C4 Crystal White Silk  
 AF2X Crystal White Bookmatch Silk  
**159x324 cm** - 62<sup>5</sup>/<sub>8</sub>"x127<sup>1</sup>/<sub>2</sub>"  
 ± 20 mm  
 AIRJ Crystal White Polished  
 AIRH Crystal White Bookmatch Polished

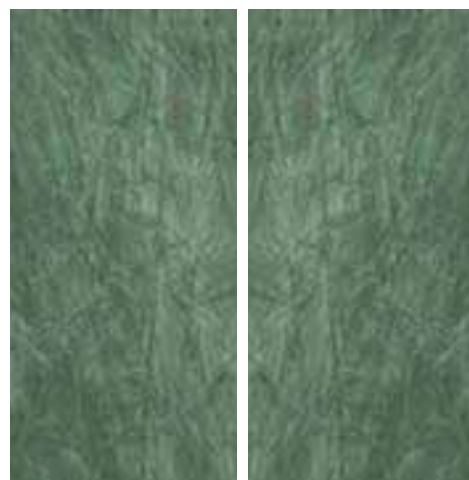

**EXOTIC GREEN** Bookmatch  
**162x324 cm** - 63<sup>3</sup>/<sub>4</sub>"x127<sup>1</sup>/<sub>2</sub>"  
 ± 12 mm ST \*  
 A9CN Exotic Green Polished  
 A9CO Exotic Green Bookmatch Polished

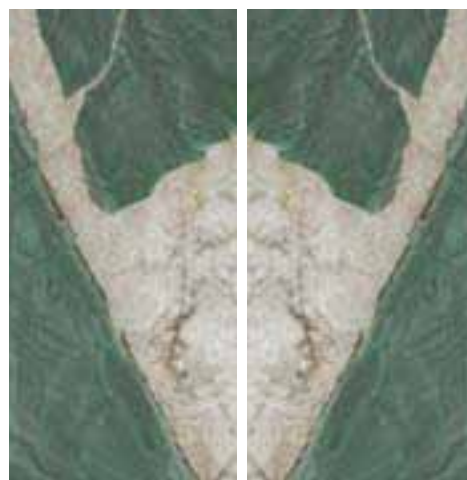

**EXOTIC WAVE** Bookmatch  
**162x324 cm** - 63<sup>3</sup>/<sub>4</sub>"x127<sup>1</sup>/<sub>2</sub>"  
 ± 12 mm ST \*  
 A9CT Exotic Wave Polished  
 A9CU Exotic Wave Bookmatch Polished



**DESERT SOUL** Bookmatch  
**162x324 cm** - 63<sup>3</sup>/<sub>4</sub>"x127<sup>1</sup>/<sub>2</sub>"  
 ± 6 mm ST \*  
 AGRC Desert Soul Polished  
 AGRD Desert Soul Bookmatch Polished  
 ± 12 mm ST \*  
 A9CW Desert Soul Polished  
 A9CX Desert Soul Bookmatch Polished  
 A9CZ Desert Soul Silk  
 A9CØ Desert Soul Bookmatch Silk  
 ± 20 mm  
 A9C7 Desert Soul Polished  
 A9C8 Desert Soul Bookmatch Polished

\* With fiberglass mesh

**162x324 cm** - 63<sup>3</sup>/<sub>4</sub>"x127<sup>1</sup>/<sub>2</sub>" Non-Rectified ± 6-12-20 mm  
**159x324 cm** - 62<sup>5</sup>/<sub>8</sub>"x127<sup>1</sup>/<sub>2</sub>" Non-Rectified ± 20 mm

## Stone Look



**KONE GYPSUM**  
**162x324 cm** - 63<sup>3</sup>/<sub>4</sub>"x127<sup>1</sup>/<sub>2</sub>"  
 ± 12 mm ST \*  
 AMKD Kone Gypsum Hammered

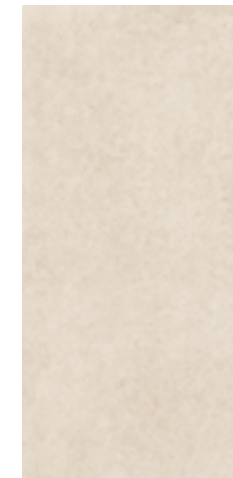

**BOOST STONE IVORY**  
**162x324 cm** - 63<sup>3</sup>/<sub>4</sub>"x127<sup>1</sup>/<sub>2</sub>"  
 ± 12 mm ST \*  
 A648 Boost Stone Ivory Hammered



**KONE MIX**  
**162x324 cm** - 63<sup>3</sup>/<sub>4</sub>"x127<sup>1</sup>/<sub>2</sub>"  
 ± 6 mm ST \*  
 ANIQ Kone Mix Hammered  
 ± 12 mm ST \*  
 AMSX Kone Mix Hammered <sup>(2)</sup>  
NATURA-BODY TECH



**DOLMEN PRO GRIGIO**  
**162x324 cm** - 63<sup>3</sup>/<sub>4</sub>"x127<sup>1</sup>/<sub>2</sub>"  
 ± 12 mm ST \*  
 A0X8 Dolmen Pro Grigio Flamed <sup>(2)</sup>  
 ± 20 mm  
 A2XP Dolmen Pro Grigio Flamed <sup>(2)</sup>  
NATURA-BODY TECH

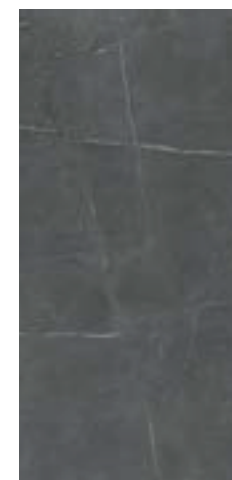

**SOAPSTONE DARK**  
**162x324 cm** - 63<sup>3</sup>/<sub>4</sub>"x127<sup>1</sup>/<sub>2</sub>"  
 ± 12 mm ST \*  
 A4UN Soapstone Dark Hammered <sup>(2)</sup>  
 ± 20 mm  
 A5I3 Soapstone Dark Hammered <sup>(2)</sup>  
NATURA-BODY TECH



**BALSATINA VOLCANO**  
**162x324 cm** - 63<sup>3</sup>/<sub>4</sub>"x127<sup>1</sup>/<sub>2</sub>"  
 ± 6 mm ST \*  
 AL9Z Basaltina Volcano Hammered  
 ± 12 mm ST \*  
 ANVI Basaltina Volcano Hammered <sup>(2)</sup>  
 ± 20 mm  
 A2XS Basaltina Volcano Hammered <sup>(2)</sup>  
NATURA-BODY TECH

INDEX ≡

A COMPLETE PRODUCT SYSTEM >

PRODUCT FINDER >

SURFACE RANGE >

COMPANY >

COLLECTIONS >

LARGE SIZES >

SLABS FOR COUNTERTOPS & FURNITURE >

MARBLE LOOK  
 STONE LOOK  
 CONCRETE LOOK  
 SOLID LOOK  
 METAL LOOK  
 NOTES

SINKS & BATHROOM FURNISHING >

FACADES >

TECHNICAL SPECIFICATIONS >

# Slabs for Countertops & Furniture

## Concrete Look

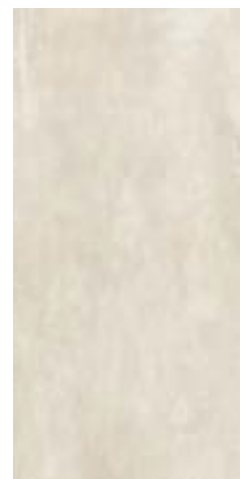

**BOOST WHITE**  
**162x324 cm** - 63<sup>3</sup>/<sub>4</sub>"x127<sup>1</sup>/<sub>2</sub>"  
 ± 12 mm ST \*

ANVX Boost White Hammered



**BOOST SMOKE**  
**162x324 cm** - 63<sup>3</sup>/<sub>4</sub>"x127<sup>1</sup>/<sub>2</sub>"  
 ± 12 mm ST \*

ANVØ Boost Smoke Hammered

± 20 mm  
 A2XV Boost Smoke Hammered



**BOOST GREY**  
**162x324 cm** - 63<sup>3</sup>/<sub>4</sub>"x127<sup>1</sup>/<sub>2</sub>"  
 ± 12 mm ST \*

A65C Boost Grey Hammered

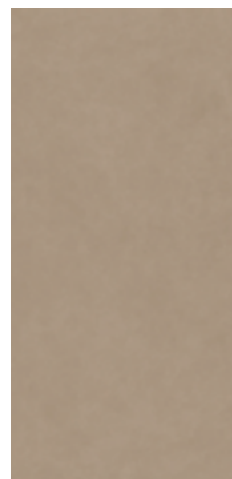

**BOOST NATURAL ECRU**  
**162x324 cm** - 63<sup>3</sup>/<sub>4</sub>"x127<sup>1</sup>/<sub>2</sub>"  
 ± 12 mm ST \*

A649 Boost Natural Ecreu Hammered



**BOOST TARMAC**  
**162x324 cm** - 63<sup>3</sup>/<sub>4</sub>"x127<sup>1</sup>/<sub>2</sub>"  
 ± 12 mm ST \*

A65D Boost Tarmac Hammered

## Solid Look

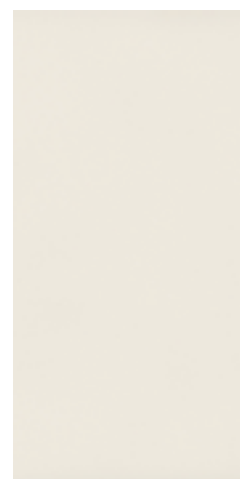

**ABSOLUTE WHITE**  
**162x324 cm** - 63<sup>3</sup>/<sub>4</sub>"x127<sup>1</sup>/<sub>2</sub>"  
 ± 6 mm ST \*

AØ7Z Absolute White Matte

± 12 mm ST \*

AGIN Absolute White Matte  
 A4T4 Absolute White Polished

**159x324 cm** - 62<sup>5</sup>/<sub>8</sub>"x127<sup>1</sup>/<sub>2</sub>"  
 ± 20 mm

AIRU Absolute White Matte  
 AILY Absolute White Polished

\* With fiberglass mesh



**ABSOLUTE BLACK**  
**162x324 cm** - 63<sup>3</sup>/<sub>4</sub>"x127<sup>1</sup>/<sub>2</sub>"  
 ± 12 mm ST \*

AG1G Absolute Black Matte



**BLACK LAVA**  
**162x324 cm** - 63<sup>3</sup>/<sub>4</sub>"x127<sup>1</sup>/<sub>2</sub>"  
 ± 12 mm ST \*

AF5A Black Lava Leathered

± 20 mm  
 AF5M Black Lava Leathered

## Metal Look



**BLAZE IRON**  
**162x324 cm** - 63<sup>3</sup>/<sub>4</sub>"x127<sup>1</sup>/<sub>2</sub>"  
 ± 12 mm ST \*

A3ND Blaze Iron Matte

**162x324 cm** - 63<sup>3</sup>/<sub>4</sub>"x127<sup>1</sup>/<sub>2</sub>" Non-Rectified ± 6-12-20 mm

**159x324 cm** - 62<sup>5</sup>/<sub>8</sub>"x127<sup>1</sup>/<sub>2</sub>" Non-Rectified ± 20 mm

atlasPLAN

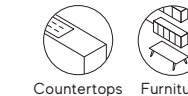

© Ceramiche Atlas Concorde



© Ceramiche Atlas Concorde



Natura-Vein™ Tech is the technology from the Concorde Group that makes it possible to recreate the typical veining of a natural material such as marble in porcelain stoneware slabs at an industrial level. This exclusive technology can also be applied to Atlas Plan slabs with a thickness of 20 mm.

Natura-Vein™ Tech è la tecnologia del Gruppo Concorde che permette di riprodurre nello spessore delle lastre in gres porcellanato la venatura tipica di un materiale naturale come il marmo. Una tecnologia esclusiva che può essere applicata alle lastre Atlas Plan con spessore di 20 mm.

Natura-Vein™ Tech est la technologie du Groupe Concorde qui offre la possibilité de recréer au niveau industriel les veines typiques d'un matériau naturel comme le marbre sur les dalles en grès cérame. Une technologie exclusive qui peut être appliquée aux dalles Atlas Plan de 20 mm d'épaisseur.

Natura-Vein™ Tech ist eine Technologie der Concorde Group, die es ermöglicht, die typische Maserung eines natürlichen Materials wie Marmor in Feinsteinzeugplatten auf industriellem Niveau nachzubilden. Eine exklusive Technologie, die auf Atlas Plan Platten mit einer Stärke von 20 mm angewendet werden kann.

Natura-Vein™ Tech es una tecnología del Grupo Concorde que da la posibilidad de recrear a nivel industrial la veta característica de un material natural como el mármol en placas de gres porcelánico. Una tecnología exclusiva que se puede aplicar a las placas Atlas Plan con espesor de 20 mm.

Natura-Vein™ Tech - это технология от Gruppo Concorde, позволяющая воссоздавать на промышленном уровне типичные вены природного материала, такого как мрамор, в керамогранитных плитках. Эта эксклюзивная технология может применяться к плиткам Atlas Plan толщиной 20 мм.



Natura-Body™ Tech is the technology from the Concorde Group that allows the aesthetics of natural stone to be reproduced across both the surface and body of the slab. This exclusive technology can also be applied to Atlas Plan slabs with a thickness of 20 mm and 12 mm.

Natura-Body™ Tech è la tecnologia del Gruppo Concorde che permette di riprodurre l'estetica della pietra naturale sia in superficie che nel corpo della lastra. Una tecnologia esclusiva che può essere applicata alle lastre Atlas Plan con spessore di 20 mm e 12 mm.

Natura-Body™ Tech est la technologie du Groupe Concorde qui permet de reproduire l'esthétique de la pierre naturelle aussi bien sur la surface que dans le corps de la dalle. Une technologie exclusive qui peut être appliquée aux dalles Atlas Plan de 20 mm et 12 mm d'épaisseur.

Natura-Body™ Tech ist eine Technologie der Concorde Group, mit der Naturstein-Optik sowohl an der Oberfläche als auch durch die Masse der Platte reproduziert werden kann. Eine exklusive Technologie, die auf Atlas Plan Platten mit einer Stärke von 20 mm und 12 mm angewendet werden kann.

Natura-Body™ Tech es una tecnología del Grupo Concord que permite reproducir la estética de la piedra natural tanto en la superficie como en el cuerpo de la placa. Una tecnología exclusiva que se puede aplicar a las placas Atlas Plan con espesor de 20 mm y 12 mm.

Natura-Body™ Tech - это технология от Gruppo Concorde, позволяющая воссоздать эстетику натурального камня, как на поверхности, так и внутри плиты. Эта эксклюзивная технология может использоваться с плиткой Atlas Plan толщиной 20 мм и 12 мм.

INDEX



A COMPLETE PRODUCT SYSTEM



PRODUCT FINDER



SURFACE RANGE



COMPANY



COLLECTIONS



LARGE SIZES



SLABS FOR COUNTERTOPS & FURNITURE



MARBLE LOOK  
 STONE LOOK  
 CONCRETE LOOK  
 SOLID LOOK  
 METAL LOOK

NOTES

SINKS & BATHROOM FURNISHING



FACADES



TECHNICAL SPECIFICATIONS







 atlas concorde habitat



# Sinks & Bathroom Furnishing

- ⇨ HARMONY OF SPACES
- ⇨ CUSTOMIZABLE FURNISHING ELEMENTS
- ⇨ LOOKS COLOR AND FINISHES
- ⇨ PRODUCT RANGE
  
- ⇨ DIALOGO In collaboration with **MARIO FERRARINI**
  
- ⇨ NOTES

INDEX



A COMPLETE PRODUCT SYSTEM >

PRODUCT FINDER >

SURFACE RANGE >

COMPANY >

COLLECTIONS >

LARGE SIZES >

SLABS FOR COUNTERTOPS & FURNITURE >

SINKS & BATHROOM FURNISHING >

HARMONY OF SPACES  
CUSTOMIZABLE FURNISHING ELEMENTS  
LOOKS COLOR AND FINISHES  
PRODUCT RANGE  
DIALOGO  
NOTES

FACADES >

TECHNICAL SPECIFICATIONS >



CONTRACT

# Harmony of spaces: coordinated furniture and surface

Atlas Concorde Habitat proposes a line of bathroom furniture entirely dedicated to the world of design, which enhances the exceptional qualities of porcelain tiles. The collection features refined and trendy solutions, which find an elegant harmonious language in the Atlas Concorde combined floor and wall tiles.

Atlas Concorde Habitat propone una linea di elementi per l'arredo bagno dedicata interamente al mondo della progettazione, che valorizza le eccezionali qualità del gres porcellanato. La collezione presenta soluzioni ricercate e di tendenza che trovano nel coordinamento con pavimenti e rivestimenti della gamma di Atlas Concorde un elegante linguaggio armonico.

Atlas Concorde Habitat propose une ligne d'éléments pour l'ameublement de salle de bains entièrement dédiée au monde de la conception, qui met en valeur les qualités exceptionnelles du grès cérame. La collection présente des solutions recherchées et tendance, qui composent un langage harmonieux élégant en coordination avec les sols et revêtements muraux de la gamme d'Atlas Concorde.

Atlas Concorde Habitat bietet eine für die Designwelt zugeschnittene Reihe von Einrichtungselementen, die die ausgezeichneten Qualitäten des Feinsteinzeugs noch weiter aufwerten. Die Kollektion bietet raffiniert trendige Designlösungen, die in der Abstimmung mit Boden- und Wandbelägen von Atlas Concorde eine elegante und harmonische Ausdrucksform finden.

Atlas Concorde Habitat propone una línea de muebles de baño pensada totalmente para el mundo del diseño de interiores, que realza las excepcionales cualidades del porcelánico. La colección presenta soluciones sofisticadas y de tendencia, que se combinan con pavimentos y revestimientos de la gama de Atlas Concorde utilizando un elegante lenguaje armónico.

Atlas Concorde Habitat предлагает линейку мебели для ванных комнат, полностью посвященную миру дизайна, которая подчеркивает исключительные качества керамогранита. В коллекции представлены изысканные и трендовые решения, которые образуют элегантные гармоничные сочетания с напольными и настенными покрытиями Atlas Concorde.



© Ceramiche Atlas Concorde



© Ceramiche Atlas Concorde



© Ceramiche Atlas Concorde

INDEX



A COMPLETE  
PRODUCT  
SYSTEM



PRODUCT  
FINDER



SURFACE  
RANGE



COMPANY



COLLECTIONS



LARGE SIZES



SLABS FOR  
COUNTERTOPS  
& FURNITURE



SINKS &  
BATHROOM  
FURNISHING



HARMONY OF SPACES  
CUSTOMIZABLE FURNISHING  
ELEMENTS  
LOOKS COLOR AND FINISHES  
PRODUCT RANGE  
DIALOGO  
NOTES

FACADES



TECHNICAL  
SPECIFICATIONS



CONTRACT

# Customizable furnishing elements



Single wall-mounted sink P.424

Twin wall-mounted sink P.425

Shelf P.426



Mastertop P.426

Sit-on basin P.427

Top P.427



\*NOTE: TOP can only be ordered in combination with sit-on basin 65x50x15 cm  
\*NOTA: Il TOP è ordinabile solo insieme al catino d'appoggio 65x50x15 cm

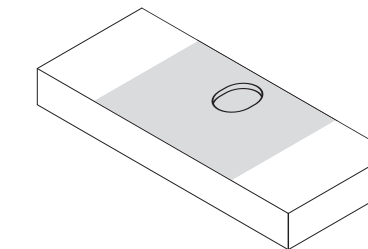
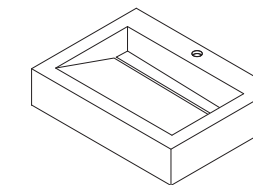
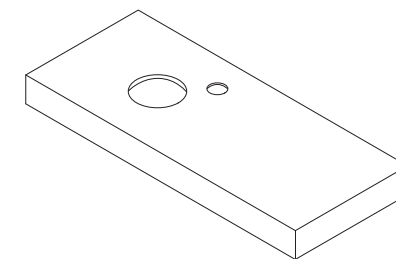
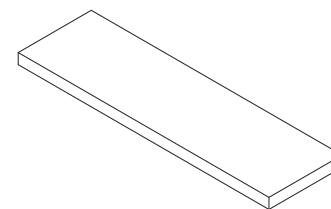
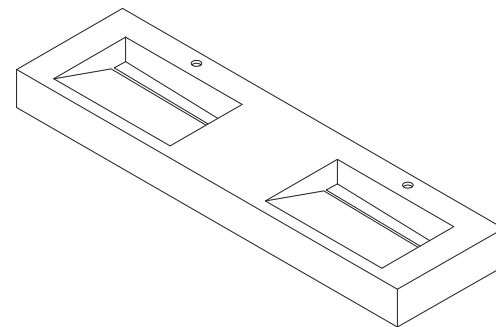
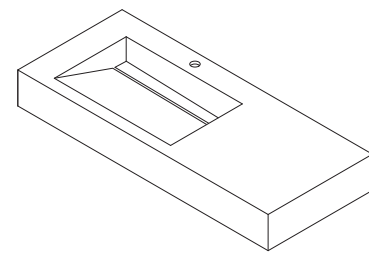

The Contract range presents a rich offer designed to support designers and architects in designing and developing bespoke solutions, while at the same time respecting industry standards. The range serves as a perfect tool to support the realization of bathrooms, with a customer-oriented approach and the highest guarantee in terms of sturdiness and reliability.

La gamma Contract presenta una ricca offerta pensata a supporto di designer ed architetti per la progettazione e lo sviluppo di soluzioni personalizzate, ma al tempo stesso nel rispetto di forti standard industriali. Lo strumento perfetto per dare supporto alla realizzazione degli ambienti bagno, con un approccio orientato al cliente e la massima garanzia in termini di solidità e affidabilità.

La gamme Contract présente une offre riche, pensée pour aider les designers et architectes dans la conception et le développement de solutions personnalisées tout en respectant des normes industrielles sévères. L'outil parfait pour faciliter la conception des salles de bains, avec une approche centrée sur le client et une garantie maximale en termes de robustesse et de fiabilité.

Das Contract-Material bietet ein reichhaltiges Angebot zur Unterstützung von Designern und Architekten beim Entwurf und der Entwicklung kundenspezifischer Lösungen, wobei gleichzeitig strenge industrielle Standards eingehalten werden. Ein perfektes Tool für die Realisierung von Badezimmern, mit einem kundenorientierten Ansatz und maximaler Garantie in Bezug auf Solidität und Zuverlässigkeit.

La gama Contract presenta una amplia oferta creada para ayudar a diseñadores y arquitectos en el diseño y desarrollo de soluciones personalizadas que cumplen con los más estrictos estándares industriales. La herramienta perfecta para crear ambientes de baño con un enfoque orientado al cliente y la máxima garantía en cuanto a solidez y fiabilidad.

Линейка Contract предлагает широкий ассортимент продукции, призванной помочь дизайнерам и архитекторам в проектировании и разработке персонализированных решений, соответствующих устоявшимся стандартам индустриального стиля. Идеальный инструмент, помогающий при разработке интерьеров ванных комнат, характеризующийся клиентоориентированным подходом и максимальной гарантией прочности и надежности.

## Customize your model

Customize length, tub position, presence of the mixer faucet hole according to the product selected.

Personalizza lunghezza, posizione della vasca, presenza del foro miscelatore in funzione del prodotto selezionato.

Personnalisez la longueur, la position de la cuve, la présence du trou du mélangeur en fonction du produit sélectionné.

Personalisieren Sie je nach dem gewählten Produkt die Länge und Position des Beckens sowie die eventuelle Aussparung für die Mischbatterie.

Personaliza la longitud, la posición de la pila y la presencia del orificio del grifo mezclador en función del producto seleccionado.

Выберите длину, расположение чаши, наличие отверстия в зависимости от выбранного изделия.

## Choose Look, Color and Finish

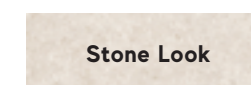

P. 418



P. 420



P. 420



P. 422

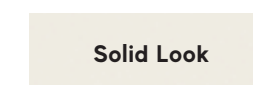

P. 421

INDEX



A COMPLETE PRODUCT SYSTEM >

PRODUCT FINDER >

SURFACE RANGE >

COMPANY >

COLLECTIONS >

LARGE SIZES >

SLABS FOR COUNTERTOPS & FURNITURE >

SINKS & BATHROOM FURNISHING >

HARMONY OF SPACES  
CUSTOMIZABLE FURNISHING ELEMENTS  
LOOKS COLOR AND FINISHES  
PRODUCT RANGE  
DIALOGO  
NOTES

FACADES >

TECHNICAL SPECIFICATIONS >

CONTRACT

# Looks, colors and finishes



## Stone Look

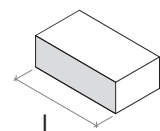

<b>Range A</b> L = From 80 cm - 31 1/2" to 119 cm - 46 7/8"	Matte	Matte	Hammered	Matte Hammered	Matte	Matte	Matte	Matte	Matte
<b>Range B</b> L = From 120 cm - 47 1/4" to 149 cm - 58 5/8"		Matte	Hammered	Matte Hammered	Matte	Matte	Matte	Matte	
<b>Range C</b> L = From 150 cm - 59" to 209 cm - 82 1/4"		Matte	Hammered	Matte Hammered	Matte	Matte	Matte	Matte	
<b>Range D</b> L = From 210 cm - 82 5/8" to 249 cm - 98"		Matte	Hammered	Matte Hammered	Matte	Matte	Matte	Matte	
<b>Range E</b> L = From 250 cm - 98 5/8" to 290 cm - 114 1/8"			Hammered	Hammered					
<b>Mastertop</b> L = 90, 120, 140, 160, 180 cm 35 1/8", 47 1/4", 55 1/8", 63", 70 7/8"		Matte		Matte		Matte	Matte		

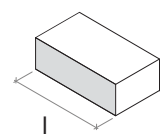

<b>Range A</b> L = From 80 cm - 31 1/2" to 119 cm - 46 7/8"	Matte	Matte Hammered	Matte	Matte	Matte	Matte	Flamed	Matte	Matte
<b>Range B</b> L = From 120 cm - 47 1/4" to 149 cm - 58 5/8"		Hammered	Matte	Matte		Matte	Flamed	Matte	Matte
<b>Range C</b> L = From 150 cm - 59" to 209 cm - 82 1/4"		Hammered	Matte	Matte		Matte	Flamed	Matte	Matte
<b>Range D</b> L = From 210 cm - 82 5/8" to 249 cm - 98"		Hammered	Matte	Matte		Matte	Flamed		Matte
<b>Range E</b> L = From 250 cm - 98 5/8" to 290 cm - 114 1/8"		Hammered					Flamed		
<b>Mastertop</b> L = 90, 120, 140, 160, 180 cm 35 1/8", 47 1/4", 55 1/8", 63", 70 7/8"			Matte	Matte		Matte			Matte



Matte	Matte	Matte	Matte	Matte	Matte	Matte	Matte	Matte	Matte	Matte
Matte	Matte	Matte					Matte	Matte		
Matte	Matte	Matte					Matte	Matte		
Matte	Matte	Matte						Matte		

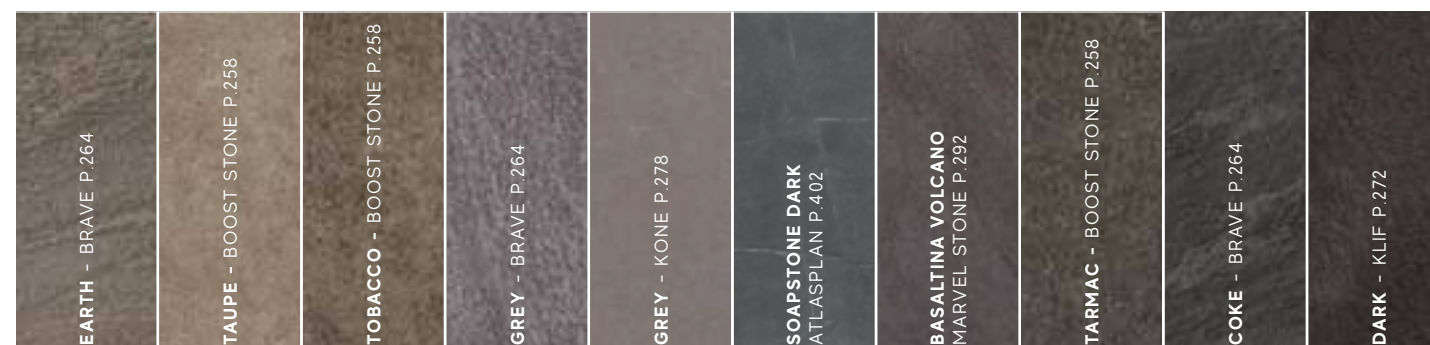

Matte	Matte	Matte	Matte	Matte Hammered	Hammered	Matte Hammered	Matte	Matte	Matte
	Matte	Matte		Hammered	Hammered	Matte Hammered	Matte		
	Matte	Matte		Hammered	Hammered	Matte Hammered	Matte		
	Matte	Matte		Hammered	Hammered	Hammered	Matte		
				Hammered	Hammered	Hammered			

INDEX



A COMPLETE PRODUCT SYSTEM >

PRODUCT FINDER >

SURFACE RANGE >

COMPANY >

COLLECTIONS >

LARGE SIZES >

SLABS FOR COUNTERTOPS & FURNITURE >

SINKS & BATHROOM FURNISHING >

HARMONY OF SPACES  
CUSTOMIZABLE FURNISHING ELEMENTS  
LOOKS COLOR AND FINISHES  
PRODUCT RANGE  
DIALOGO  
NOTES

FACADES >

TECHNICAL SPECIFICATIONS >

CONTRACT

# Looks, colors and finishes



## Concrete Look

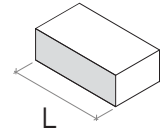

<b>Range A</b> L = From 80 cm - 31 1/2" to 119 cm - 46 7/8"	Matte	Matte	Matte	Matte	Matte Hammered	Matte	Matte	Matte	Matte
<b>Range B</b> L = From 120 cm - 47 1/4" to 149 cm - 58 5/8"	Matte	Matte	Matte	Matte	Matte Hammered	Matte	Matte	Matte	Matte
<b>Range C</b> L = From 150 cm - 59" to 209 cm - 82 1/4"	Matte	Matte	Matte	Matte	Matte Hammered	Matte	Matte	Matte	Matte
<b>Range D</b> L = From 210 cm - 82 5/8" to 249 cm - 98"	Matte	Matte	Matte	Matte	Matte Hammered	Matte	Matte	Matte	Matte
<b>Range E</b> L = From 250 cm - 98 5/8" to 290 cm - 114 1/8"					Matte Hammered				
<b>Mastertop</b> L = 90, 120, 140, 160, 180 cm 35 1/8", 47 1/4", 55 1/8", 63", 70 7/8"	Matte	Matte	Matte	Matte	Matte	Matte	Matte	Matte	Matte

## Concrete Look

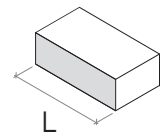

<b>Range A</b> L = From 80 cm - 31 1/2" to 119 cm - 46 7/8"	Matte	Matte Hammered	Matte
<b>Range B</b> L = From 120 cm - 47 1/4" to 149 cm - 58 5/8"	Matte	Matte Hammered	Matte
<b>Range C</b> L = From 150 cm - 59" to 209 cm - 82 1/4"	Matte	Matte Hammered	Matte
<b>Range D</b> L = From 210 cm - 82 5/8" to 249 cm - 98"	Matte	Matte Hammered	Matte
<b>Range E</b> L = From 250 cm - 98 5/8" to 290 cm - 114 1/8"		Matte Hammered	
<b>Mastertop</b> L = 90, 120, 140, 160, 180 cm 35 1/8", 47 1/4", 55 1/8", 63", 70 7/8"	Matte	Matte	Matte

## Metal Look

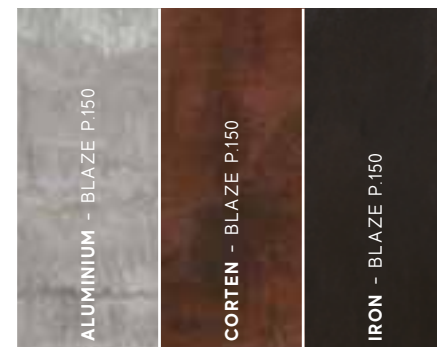

Matte	Matte	Matte
Matte	Matte	Matte
Matte	Matte	Matte
Matte	Matte	Matte
		Matte
		Matte



Matte Hammered	Matte	Matte	Matte	Matte Hammered	Matte	Matte	Matte	Matte	Matte	Matte Hammered
Matte Hammered	Matte	Matte	Matte	Matte Hammered	Matte	Matte	Matte	Matte	Matte	Matte Hammered
Matte Hammered	Matte	Matte	Matte	Matte Hammered	Matte	Matte	Matte	Matte	Matte	Matte Hammered
Matte Hammered	Matte	Matte	Matte	Matte Hammered	Matte	Matte	Matte	Matte	Matte	Matte Hammered
Hammered			Matte	Matte Hammered		Matte				Matte Hammered
Matte	Matte		Matte	Matte		Matte	Matte	Matte	Matte	Matte

## Solid Look

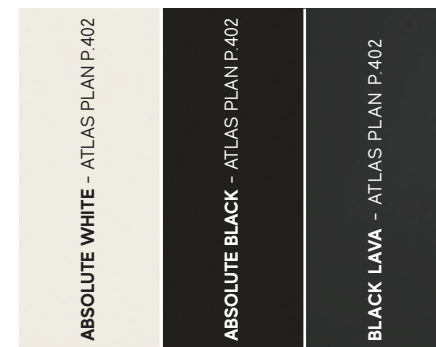

Matte Polished	Matte	Leathered
Matte Polished	Matte	Leathered
Matte Polished	Matte	Leathered
Matte Polished	Matte	Leathered
Matte Polished	Matte	Leathered

CONTRACT

# Looks, colors and finishes



## Marble Look

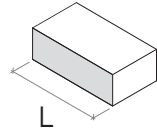

<b>Range A</b> L = From 80 cm - 31 1/2" to 119 cm - 46 7/8"	CARRARA PURE MARVEL STONE P.218	CALACATTA EXTRA MARVEL P.158	STATUARIO SELECT MARVEL PRO P.194	STATUARIO SUPREMO MARVEL SHINE P.206	BIANCO DOLOMITE MARVEL STONE P.218	CRYSTAL WHITE MARVEL GALA P.188	CALACATTA APIJANO MARVEL X P.236	CALACATTA DELICATO MARVEL SHINE P.206	CALACATTA PRESTIGIO MARVEL SHINE P.206	CHAMPAGNE ONYX MARVEL P.158	CREMO DELICATO MARVEL PRO P.194
<b>Range B</b> L = From 120 cm - 47 1/4" to 149 cm - 58 5/8"	Polished Matte	Polished Silk Matte	Polished	Polished Silk Satin	Polished Matte	Polished Silk	Polished Silk	Polished Silk	Polished Silk	Polished	Polished Silk
<b>Range C</b> L = From 150 cm - 59" to 209 cm - 82 1/4"	Polished Matte	Polished Silk Matte	Polished	Polished Silk Satin	Polished Matte	Polished Silk	Polished Silk	Polished Silk	Polished Silk		Polished Matte
<b>Range D</b> L = From 210 cm - 82 5/8" to 249 cm - 98"	Polished Matte	Polished Silk Matte	Polished	Polished Silk Satin	Polished Matte	Polished Silk	Polished Silk	Polished Silk	Polished Silk		Polished Matte
<b>Range E</b> L = From 250 cm - 98 5/8" to 290 cm - 114 1/8"		Polished Silk Matte	Polished	Polished Silk Satin	Polished	Polished Silk	Polished	Silk	Polished Silk		Matte
<b>Mastertop</b> L = 90, 120, 140, 160, 180 cm 35 3/8", 47 1/4", 55 1/8", 63", 70 7/8"	Polished Matte	Polished Matte		Polished Silk	Polished Matte	Polished	Polished Silk	Polished	Polished Silk		Polished Matte

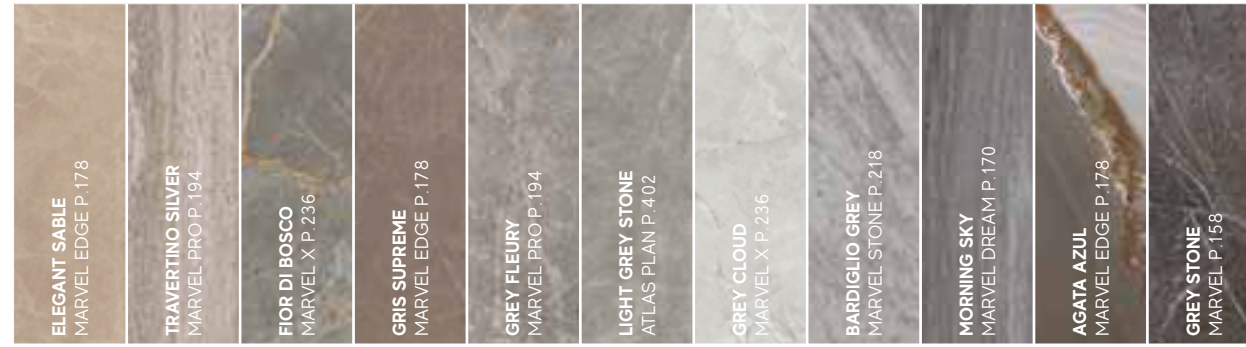
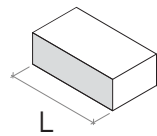

<b>Range A</b> L = From 80 cm - 31 1/2" to 119 cm - 46 7/8"	ELEGANT SABLE MARVEL EDGE P.178	TRAVERTINO SILVER MARVEL PRO P.194	FIOR DI BOSCO MARVEL X P.236	GRIS SUPREME MARVEL EDGE P.178	GREY FLEURY MARVEL PRO P.194	LIGHT GREY STONE ATLAS PLAN P.402	GREY CLOUD MARVEL X P.236	BARDIGLIO GREY MARVEL STONE P.218	MORNING SKY MARVEL DREAM P.170	AGATA AZUL MARVEL EDGE P.178	GREY STONE MARVEL P.158
<b>Range B</b> L = From 120 cm - 47 1/4" to 149 cm - 58 5/8"	Polished	Polished	Polished Silk	Polished	Polished Matte	Silk	Polished Silk	Polished	Polished Matte	Polished	Polished Silk Matte
<b>Range C</b> L = From 150 cm - 59" to 209 cm - 82 1/4"			Polished Silk		Polished Matte	Silk	Polished Silk				Polished Silk Matte
<b>Range D</b> L = From 210 cm - 82 5/8" to 249 cm - 98"			Polished Silk		Polished Matte	Silk	Polished Silk				Polished Silk Matte
<b>Range E</b> L = From 250 cm - 98 5/8" to 290 cm - 114 1/8"						Silk					Silk
<b>Mastertop</b> L = 90, 120, 140, 160, 180 cm 35 3/8", 47 1/4", 55 1/8", 63", 70 7/8"			Polished Silk		Polished Matte		Polished Silk				Polished Matte

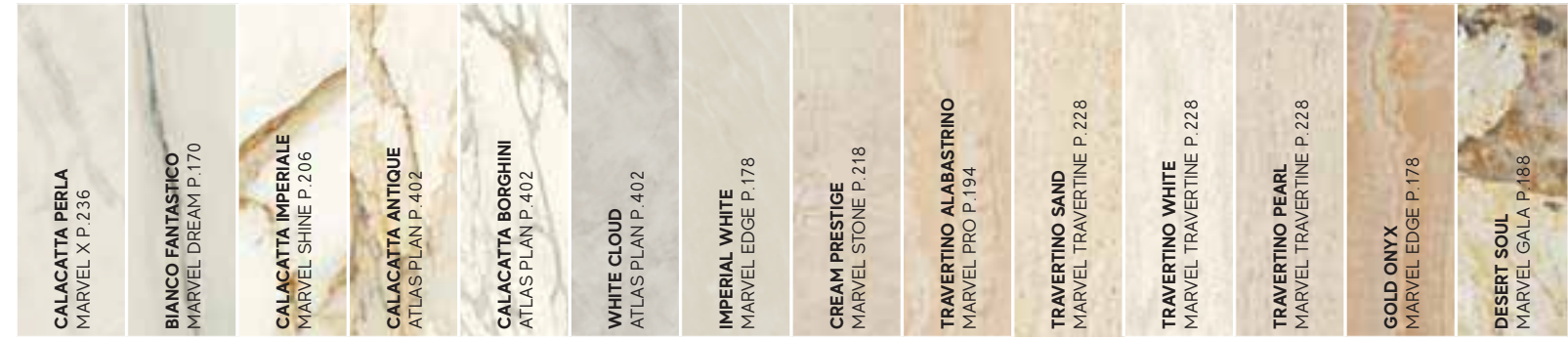

<b>Range E</b> L = From 250 cm - 98 5/8" to 290 cm - 114 1/8"	CALACATTA PERLA MARVEL X P.236	BIANCO FANTASTICO MARVEL DREAM P.170	CALACATTA IMPERIALE MARVEL SHINE P.206	CALACATTA ANTIQUE ATLAS PLAN P.402	CALACATTA BORGHINI ATLAS PLAN P.402	WHITE CLOUD ATLAS PLAN P.402	IMPERIAL WHITE MARVEL EDGE P.178	CREAM PRESTIGE MARVEL STONE P.218	TRAVERTINO ALABASTRINO MARVEL PRO P.194	TRAVERTINO SAND MARVEL TRAVERTINE P.228	TRAVERTINO WHITE MARVEL TRAVERTINE P.228	TRAVERTINO PEARL MARVEL TRAVERTINE P.228	GOLD ONYX MARVEL EDGE P.178	DESERT SOUL MARVEL GALA P.188
	Polished Silk	Polished Matte	Polished Silk Satin	Polished	Polished Silk	Silk	Polished	Polished Silk	Polished	Matte Hammered	Matte	Matte Hammered	Polished	Polished Silk
	Polished Silk	Polished Matte	Polished Silk Satin	Polished	Polished Silk	Silk		Silk		Matte Hammered	Matte	Matte Hammered		Polished Silk
	Polished Silk	Polished Matte	Polished Silk Satin	Polished	Polished Silk	Silk		Silk		Matte Hammered	Matte	Matte Hammered		Polished Silk
	Polished Silk	Polished Matte	Polished Silk Satin	Polished	Polished Silk	Silk		Silk		Matte Hammered	Matte	Matte Hammered		Polished Silk
			Polished Silk Satin	Polished	Polished Silk	Silk		Silk		Hammered		Hammered		Polished Silk
	Polished		Polished							Matte	Matte	Matte		Polished

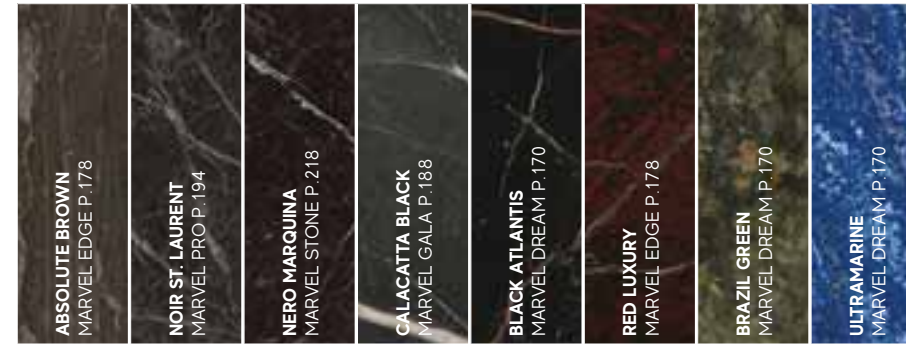

<b>Range E</b> L = From 250 cm - 98 5/8" to 290 cm - 114 1/8"	ABSOLUTE BROWN MARVEL EDGE P.178	NOIR ST. LAURENT MARVEL PRO P.194	NERO MARQUINA MARVEL STONE P.218	CALACATTA BLACK MARVEL GALA P.188	BLACK ATLANTIS MARVEL DREAM P.170	RED LUXURY MARVEL EDGE P.178	BRAZIL GREEN MARVEL DREAM P.170	ULTRAMARINE MARVEL DREAM P.170
	Polished	Polished	Polished Silk Satin	Polished	Polished Silk Matte	Polished	Polished	Polished
	Polished		Polished Silk Satin	Polished	Polished Silk Matte			Polished
	Polished		Polished Silk Satin	Polished	Polished Silk Matte			Polished
	Polished		Polished Silk Satin	Polished	Polished Silk Matte			Polished
			Polished Silk Satin		Silk			
				Polished	Polished Matte			Polished

INDEX



A COMPLETE PRODUCT SYSTEM



PRODUCT FINDER



SURFACE RANGE



COMPANY



COLLECTIONS



LARGE SIZES



SLABS FOR COUNTERTOPS & FURNITURE



SINKS & BATHROOM FURNISHING



HARMONY OF SPACES  
CUSTOMIZABLE FURNISHING ELEMENTS  
LOOKS COLOR AND FINISHES  
PRODUCT RANGE  
DIALOGO  
NOTES

FACADES



TECHNICAL SPECIFICATIONS



## CONTRACT

## Product Range

## Single Wall-mounted Sink

Lavabo da parete singolo

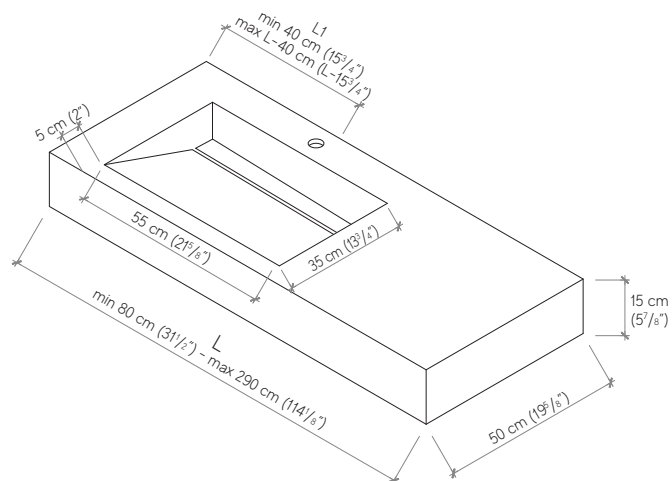

Bottom tiling is not provided  
Non è previsto il rivestimento inferiore

## DIMENSIONS / Dimensioni

Customisable length L / Lunghezza personalizzabile L

Depth 50 cm (19 5/8") / Profondità 50 cm

Height 15 cm (5 7/8") / Altezza 15 cm

## STRUCTURE / Struttura

Reinforcement: continuous panel / Rinforzo: pannello continuo

Brackets: stainless steel with holes Ø 10 mm (3/8")

Staffe: acciaio inossidabile con fori Ø 10 mm

## FAUCET AND FITTING HOLES / Fori rubinetteria

Ø 35 mm (1 3/8") / Ø 35 mm

Faucet hole always centred with the basin / Foro rubinetto sempre centrato rispetto alla vasca

Starting slab Range	75x150-9mm 29 1/2"x59"-3 1/8"	120x240-9mm 47 1/4"x94 1/2"-3 1/8"	120x278-6mm 47 1/4"x109 1/2"-3 1/4"	162x324-12mm 63 3/4"x127 1/2"-1 1/2"
Range A L = from 80 cm - 31 1/2" to 119 cm - 46 7/8"	•	•	•	•
Range B L = from 120 cm - 47 1/4" to 149 cm - 58 5/8"		•	•	•
Range C L = from 150 cm - 59" to 209 cm - 82 1/4"		•	•	•
Range D L = from 210 cm - 82 1/8" to 249 cm - 98"			•	•
Range E L = from 250 cm - 98 3/8" to 290 cm - 114 1/8"				•

## INFORMATION FOR ALL PRODUCTS / Informazioni per tutti i modelli

## LOOKS, COLORS AND FINISHES / Look, colori e finiture

Looks, colors and finishes chart from page 418 to 423 of the catalogue

Tabella look, colori e finiture da pagina 418 a 423 del catalogo

## BASIN / Vasca

Dimension 55x35 cm (21 5/8" x 13 3/4") / Dimensione 55x35 cm

Stainless steel, with porcelain tiling in single sloped pitch

Acciaio inossidabile, rivestita in gres porcellanato a singola falda inclinata

Customisable off-centre L1<sup>10</sup> / Decentramento personalizzabile L1

Overflow hole not present / Foro troppo pieno non presente

Drain diameter: 1 1/4" (drain not included) / Diametro piletta: 1 1/4" (piletta non inclusa)

Distance between drain hole and wall: approx. 14.3 cm (5 5/8")

Interasse scarico da foro piletta - parete: 14,3 cm ca.



## Twin Wall-mounted Sink

Lavabo da parete doppio

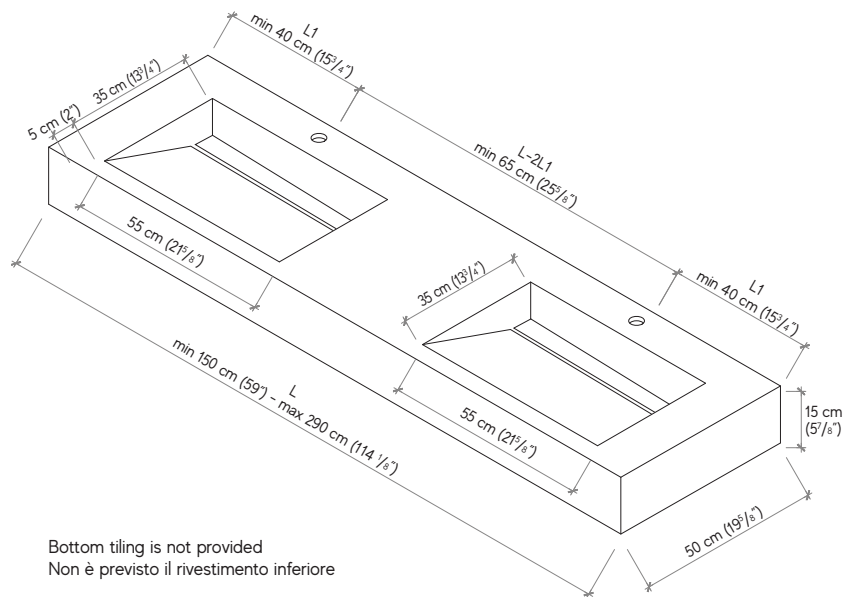

Bottom tiling is not provided  
Non è previsto il rivestimento inferiore

## DIMENSIONS / Dimensioni

Customisable length L / Lunghezza personalizzabile L

Depth 50 cm (19 5/8") / Profondità 50 cm

Height 15 cm (5 7/8") / Altezza 15 cm

## STRUCTURE / Struttura

Reinforcement: continuous panel / Rinforzo: pannello continuo

Brackets: stainless steel with holes Ø 10 mm (3/8")

Staffe: acciaio inossidabile con fori Ø 10 mm

## FAUCET AND FITTING HOLES / Fori rubinetteria

Ø 35 mm (1 3/8") / Ø 35 mm

Faucet hole always centred with the basin / Foro rubinetto sempre centrato rispetto alla vasca

Starting slab Range	75x150-9mm 29 1/2"x59"-3 1/8"	120x240-9mm 47 1/4"x94 1/2"-3 1/8"	120x278-6mm 47 1/4"x109 1/2"-3 1/4"	162x324-12mm 63 3/4"x127 1/2"-1 1/2"
Range A L = from 80 cm - 31 1/2" to 119 cm - 46 7/8"				
Range B L = from 120 cm - 47 1/4" to 149 cm - 58 5/8"				
Range C L = from 150 cm - 59" to 209 cm - 82 1/4"		•	•	•
Range D L = from 210 cm - 82 1/8" to 249 cm - 98"			•	•
Range E L = from 250 cm - 98 3/8" to 290 cm - 114 1/8"				•

## BASIN / Vasca

Dimension 55x35 cm (21 5/8" x 13 3/4") / Dimensione 55x35 cm

Stainless steel, with porcelain tiling in single sloped pitch

Acciaio inossidabile, rivestita in gres porcellanato a singola falda inclinata

Customisable off-centre L1 / Decentramento personalizzabile L1

Minimum distance from basin centre to left-hand edge approx. 40 cm (15 3/4")

Distanza minima da centro vasca a bordo sinistro 40 cm ca.

Minimum distance from basin-to-basin centre approx. 65 cm (25 5/8")

Distanza minima da centro vasca a centro vasca 65 cm ca.

Overflow hole not present / Foro troppo pieno non presente

Drain diameter: 1 1/4" (drain not included) / Diametro piletta: 1 1/4" (piletta non inclusa)

Distance between drain hole and wall: approx. 14.3 cm (5 5/8")

Interasse scarico da foro piletta - parete: 14,3 cm ca.

INDEX



A COMPLETE  
PRODUCT  
SYSTEM



PRODUCT  
FINDER



SURFACE  
RANGE



COMPANY



COLLECTIONS



LARGE SIZES



SLABS FOR  
COUNTERTOPS  
& FURNITURE



SINKS &  
BATHROOM  
FURNISHING



HARMONY OF SPACES  
CUSTOMIZABLE FURNISHING  
ELEMENTS  
LOOKS COLOR AND FINISHES

PRODUCT RANGE

DIALOGO

NOTES

FACADES



TECHNICAL  
SPECIFICATIONS



## CONTRACT

## Product Range

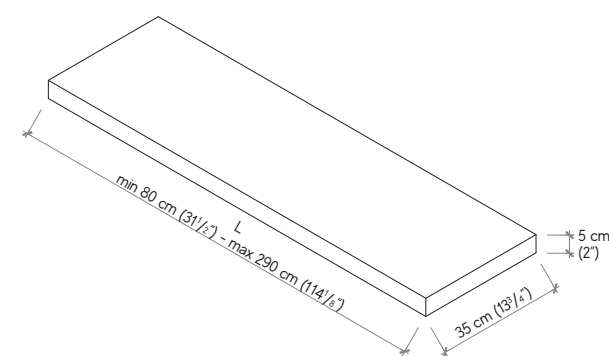
Shelf  
Mensola

Bottom tiling is not provided  
Non è previsto il rivestimento inferiore

## DIMENSIONS / Dimensioni

Customisable length L / Lunghezza personalizzabile L  
Depth 35 cm (13 7/8") / Profondità 35 cm  
Height 5 cm (2") / Altezza 5 cm

## STRUCTURE / Struttura

Reinforcement: continuous panel / Rinforzo: pannello continuo

Starting slab Range	75x150-9mm 29 1/2" x 59"-3/8"	120x240-9mm 47 1/4" x 94 1/2"-3/8"	120x278-6mm 47 1/4" x 109 1/2"-1/4"	162x324-12mm 63 3/4" x 127 1/2"-1/2"
Range A L = from 80 cm - 31 1/2" to 119 cm - 46 7/8"	•	•	•	•
Range B L = from 120 cm - 47 1/4" to 149 cm - 58 7/8"		•	•	•
Range C L = from 150 cm - 59" to 209 cm - 82 1/4"		•	•	•
Range D L = from 210 cm - 82 5/8" to 249 cm - 98"			•	•
Range E L = from 250 cm - 98 7/8" to 290 cm - 114 1/8"				•

## INFORMATION FOR ALL PRODUCTS / Informazioni per tutti i modelli

## LOOKS, COLORS AND FINISHES / Look, colori e finiture

Looks, colors and finishes chart from page 418 to 423 of the catalogue  
Tabella look, colori e finiture da pagina 418 a 423 del catalogo

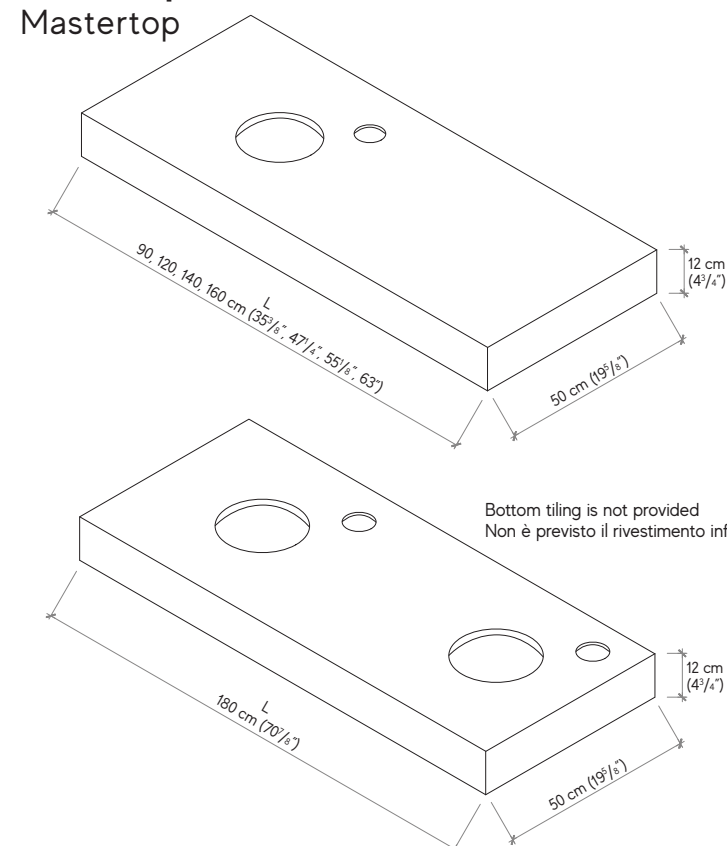
Mastertop  
Mastertop

Bottom tiling is not provided  
Non è previsto il rivestimento inferiore

## DIMENSIONS / Dimensioni

Length 90, 120, 140, 160, 180 cm (35 3/8", 47 1/4", 55 1/8", 63", 70 7/8") / Lunghezza 90, 120, 140, 160, 180 cm  
Depth 50 cm (19 5/8") / Profondità 50 cm  
Height 12 cm (4 7/8") / Altezza 12 cm

## STRUCTURE / Struttura

Reinforcement: continuous panel / Rinforzo: pannello continuo  
Brackets: stainless steel with holes Ø 10 mm (3/8")  
Staffe: acciaio inossidabile con fori Ø 10 mm

## FAUCET AND FITTING HOLES / Fori rubinetteria

Ø 35 mm (1 3/8") / Ø 35 mm

Starting slab Range	120x278-6mm 47 1/4" x 109 1/2"-1/4"
Length 35 3/8", 47 1/4", 55 1/8", 63", 70 7/8" Lunghezza 90, 120, 140, 160, 180 cm	•

## WEIGHT AND PACKAGING / Peso ed Imballo

Supplied with brackets / Forniti con staffe

Supplied with case packaging / Forniti con imballo in cassa



## SIT-ON BASIN

## Catino da appoggio

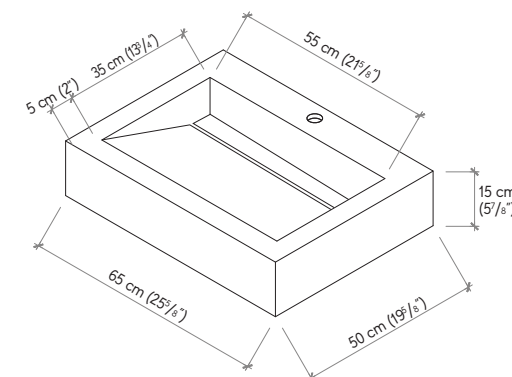

Bottom tiling is not provided  
Non è previsto il rivestimento inferiore

## FIXED DIMENSIONS / Dimensioni fisse

Length 65 cm (25 5/8") / Lunghezza 65 cm  
Depth 50 cm (19 5/8") / Profondità 50 cm  
Height 15 cm (5 7/8") / Altezza 15 cm

## STRUCTURE / Struttura

Reinforcement: continuous panel / Rinforzo: pannello continuo

## BASIN / Vasca

Dimension 55x35 cm (21 5/8" x 13 3/4") / Dimensione 55x35 cm  
Stainless steel, with porcelain tiling in single sloped pitch  
Overflow hole not present / Foro troppo pieno non presente  
Drain diameter: 1 1/4" (drain not included) / Diametro piletta: 1 1/4" (piletta non inclusa)  
Distance between drain hole and wall: approx. 14.3 cm (5 5/8") with or without faucet hole  
Interasse scarico da foro piletta - parete: 14,3 cm ca, con o senza foro rubinetteria

## FAUCET AND FITTING HOLES / Fori rubinetteria

Ø 35 mm (1 3/8") / Ø 35 mm

Faucet hole always centred with the basin / Foro rubinetto sempre centrato rispetto alla vasca

Starting slab Range	75x150-9mm 29 1/2" x 59"-3/8"	120x240-9mm 47 1/4" x 94 1/2"-3/8"	120x278-6mm 47 1/4" x 109 1/2"-1/4"	162x324-12mm 63 3/4" x 127 1/2"-1/2"
Range A L = from 80 cm - 31 1/2" to 119 cm - 46 7/8"	•	•	•	•

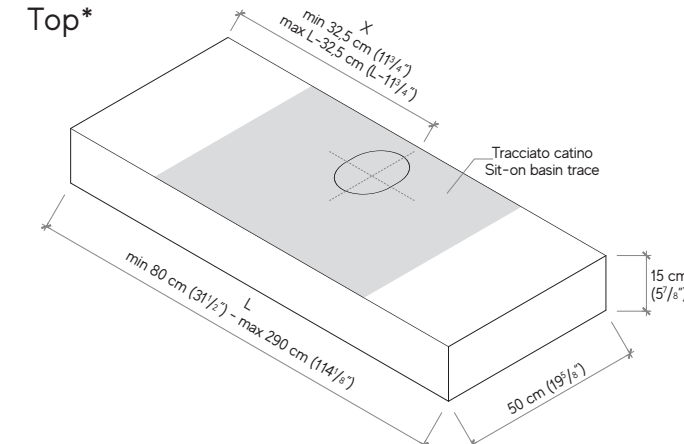
TOP\*  
Top\*

Bottom tiling is not provided  
Non è previsto il rivestimento inferiore

## DIMENSIONS / Dimensioni

Customisable length L / Lunghezza personalizzabile L  
Depth 50 cm (19 5/8") / Profondità 50 cm  
Height 15 cm (5 7/8") / Altezza 15 cm

## STRUCTURE / Struttura

Reinforcement: continuous panel / Rinforzo: pannello continuo  
Brackets: stainless steel with holes Ø 10 mm (3/8")  
Staffe: acciaio inossidabile con fori Ø 10 mm

## BASIN HOLE / Foro catino

Customisable sit-on basin position X / Posizione catino personalizzabile X

Starting slab Range	75x150-9mm 29 1/2" x 59"-3/8"	120x240-9mm 47 1/4" x 94 1/2"-3/8"	120x278-6mm 47 1/4" x 109 1/2"-1/4"	162x324-12mm 63 3/4" x 127 1/2"-1/2"
Range A L = from 80 cm - 31 1/2" to 119 cm - 46 7/8"	•	•	•	•
Range B L = from 120 cm - 47 1/4" to 149 cm - 58 7/8"		•	•	•
Range C L = from 150 cm - 59" to 209 cm - 82 1/4"		•	•	•
Range D L = from 210 cm - 82 5/8" to 249 cm - 98"			•	•
Range E L = from 250 cm - 98 7/8" to 290 cm - 114 1/8"				•

\* NOTE: TOP can only be ordered in combination with sit-on basin 65x50x15  
\* NOTA: Il TOP è ordinabile solo insieme al catino d'appoggio 65x50x15

## INDEX

A COMPLETE  
PRODUCT  
SYSTEMPRODUCT  
FINDERSURFACE  
RANGE

## COMPANY



## COLLECTIONS



## LARGE SIZES

SLABS FOR  
COUNTERTOPS  
& FURNITURESINKS &  
BATHROOM  
FURNISHING

HARMONY OF SPACES  
CUSTOMIZABLE FURNISHING  
ELEMENTS  
LOOKS COLOR AND FINISHES

## PRODUCT RANGE

DIALOGO

NOTES

## FACADES

TECHNICAL  
SPECIFICATIONS

DESIGN COLLECTION

# Dialogo



reddot winner 2022

In collaboration with  
**Mario Ferrarini**

The Dialogo was born from our collaboration with Mario Ferrarini. This collection of exclusive designs features assiduously crafted combinations of washbasins, coordinated furnitur and Atlas Concorde floor and wall tile collections.

Dalla collaborazione con Mario Ferrarini è nata Dialogo, una collezione di design esclusiva che propone abbinamenti attentamente studiati tra lavabi, mobili coordinati e collezioni di pavimenti e rivestimenti Atlas Concorde.

La collaboration avec Mario Ferrarini a donné naissance Dialogo, une collection de design exclusive qui propose des associations soigneusement étudiées entre les lavabos, les meubles coordonnés et les collections de carreaux sol et mur Atlas Concorde.

Aus der Zusammenarbeit mit Mario Ferrarini stammt Dialogo, eine exklusive Design-Kollektion für perfekte Kombinationen aus Waschbecken, passend abgestimmtem Badmobiliar und den Kollektionen der Wand- und Bodenbeläge von Atlas Concorde.

De la colaboración con Mario Ferrarini nació Dialogo, una colección de diseño exclusivo que ofrece combinaciones de lavabos, muebles a juego y colecciones de pavimentos y revestimientos Atlas Concorde.

Результатом сотрудничества с Mario Ferrarini стала коллекция Dialogo - эксклюзивная дизайнерская коллекция, предлагающая тщательно разработанные комбинации раковин, подобранной мебели и коллекций напольной и настенной плитки Atlas Concorde.



© Ceramiche Atlas Concorde



© Ceramiche Atlas Concorde



© Ceramiche Atlas Concorde

INDEX



A COMPLETE PRODUCT SYSTEM >

PRODUCT FINDER >

SURFACE RANGE >

COMPANY >

COLLECTIONS >

LARGE SIZES >

SLABS FOR COUNTERTOPS & FURNITURE >

SINKS & BATHROOM FURNISHING >

HARMONY OF SPACES  
CUSTOMIZABLE FURNISHING  
ELEMENTS  
LOOKS COLOR AND FINISHES  
PRODUCT RANGE  
DIALOGO

NOTES

FACADES >

TECHNICAL SPECIFICATIONS >



DESIGN COLLECTION

# Product Range

## Designer Sink

Lavabo d'Autore



© Ceramiche Atlas Concorde

### WITHOUT FAUCET HOLE

Senza foro rubinetteria

130x40x17,5 cm | 51 1/8"x15 3/4"x6 7/8"

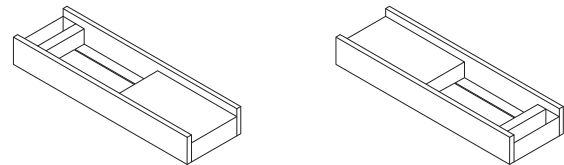

Top / Piano h 12,5 cm | 4 7/8"  
Edge / Bordo h 17,5 cm | 6 7/8"

Complete with fixing brackets / Completo di staffe per il fissaggio  
Black (RAL 9005) integrated towel holder  
Portasciugamano nero (RAL 9005) integrato al lavabo

### INFORMATION FOR ALL PRODUCTS

INFORMAZIONI PER TUTTI I MODELLI

#### BASIN TECHNICAL DETAILS / Caratteristiche tecniche vasca

Size / Dimensione 55x34 cm | 21 5/8"x13 3/8"

Stainless steel, with porcelain tiling / In acciaio inox rivestita in gres porcellanato

Overflow hole not present / Foro troppo pieno non presente

Universal diameter drain (not included) 1 1/4" / Diametro piletta universale (non inclusa) 1 1/4"

Complete with fixing brackets / Completo di staffe per il fissaggio

## Single Wall-mounted Sink

Lavabo da parete singolo



© Ceramiche Atlas Concorde

### WITHOUT FAUCET HOLE

Senza foro rubinetteria

100x40x12,5 cm | 39 3/8"x15 3/4"x4 7/8"

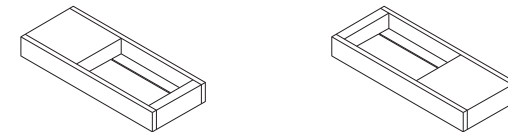

120x40x12,5 cm | 47 1/4"x15 3/4"x4 7/8"

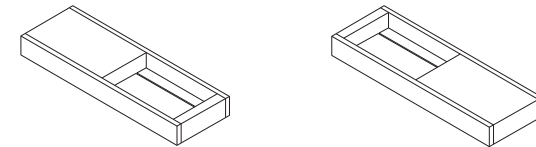

### WITH FAUCET HOLE

Con foro rubinetteria

Faucets and fittings holes / Fori rubinetteria Ø35 mm | 1 3/8"

67x50x12,5 cm | 26 3/8"x19 5/8"x4 7/8"

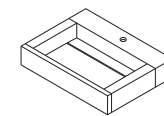

80x50x12,5 cm | 31 1/2"x19 5/8"x4 7/8"

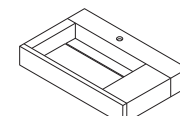

100x50x12,5 cm | 39 3/8"x19 5/8"x4 7/8"

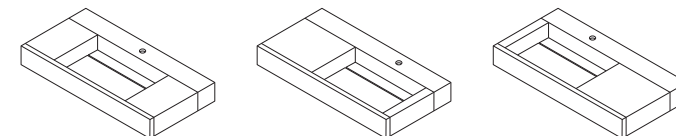

120x50x12,5 cm | 47 1/4"x19 5/8"x4 7/8"

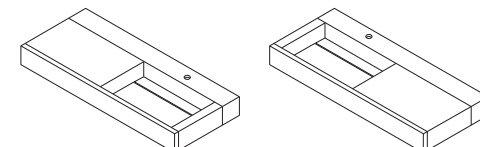

CE EN 14688

## Twin wall-mounted Sink

Lavabo da parete doppio



© Ceramiche Atlas Concorde

### WITHOUT FAUCET HOLE

Senza foro rubinetteria

150x40x12,5 cm | 59"x15 3/4"x4 7/8"

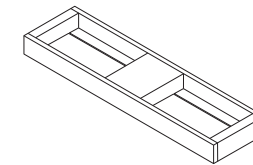

### WITH FAUCET HOLE

Con foro rubinetteria

Faucets and fittings holes / Fori rubinetteria Ø35 mm | 1 3/8"

150x50x12,5 cm | 59"x19 5/8"x4 7/8"

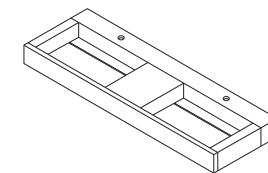

## Sit-on basin

Catino da appoggio



© Ceramiche Atlas Concorde

### WITHOUT FAUCET HOLE

Senza foro rubinetteria

67x40x12,5 cm | 26 3/8"x15 3/4"x4 7/8"

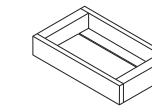

atlas concorde habitat



## Free-Standing

Free-standing



© Ceramiche Atlas Concorde

### WITHOUT FAUCET HOLE

Senza foro rubinetteria

67x40x85 cm | 26 3/8"x15 3/4"x33 1/2"

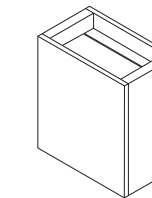

INDEX



A COMPLETE PRODUCT SYSTEM >

PRODUCT FINDER >

SURFACE RANGE >

COMPANY >

COLLECTIONS >

LARGE SIZES >

SLABS FOR COUNTERTOPS & FURNITURE >

SINKS & BATHROOM FURNISHING >

HARMONY OF SPACES  
CUSTOMIZABLE FURNISHING  
ELEMENTS  
LOOKS COLOR AND FINISHES  
PRODUCT RANGE

DIALOGO

NOTES

FACADES >

TECHNICAL SPECIFICATIONS >

DESIGN COLLECTION

# Product Range

## Designer Drawer Unit Cassettiera d'Autore



© Ceramiche Atlas Concorde

120x40x32 cm | 47 1/4"x15 3/4"x12 5/8"

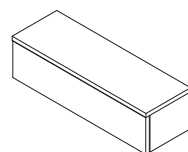

## Single Wall-mounted Drawer Unit Cassettiera singola sospesa



© Ceramiche Atlas Concorde

100x40x32 cm | 39 3/8"x15 3/4"x12 5/8"

120x40x32 cm | 47 1/4"x15 3/4"x12 5/8"

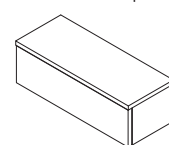

67x50x32 cm | 26 3/8"x19 5/8"x12 5/8"

80x50x32 cm | 31 1/2"x19 5/8"x12 5/8"

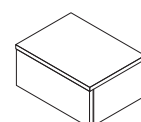

100x50x32 cm | 39 3/8"x19 5/8"x12 5/8"

120x50x32 cm | 47 1/4"x19 5/8"x12 5/8"

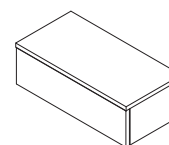

## Twin wall-mounted Drawer Unit Cassettiera doppia sospesa



© Ceramiche Atlas Concorde

150x40x32 cm | 59"x15 3/4"x12 5/8"

150x50x32 cm | 59"x19 5/8"x12 5/8"

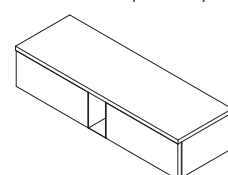

### INFORMATION FOR ALL PRODUCTS INFORMAZIONI PER TUTTI I MODELLI

#### STRUCTURE / Struttura

Porcelain tiles upper tiling / Rivestimento superiore in gres porcellanato

Matt lacquered MDF casing, 1 1/4" thick (Only for designer drawer unit) / Scocca in MDF spessore 3,2 cm laccata opaca (Solo per Cassettiera d'Autore)

Black open compartment (RAL 9005) / Vano a giorno nero (RAL 9005)

#### DRAWER / Cassetto

Front thickness: 1 1/4" / Spessore frontale: 3,2 cm

Interior clearance: 8 5/8" / Luce interna: 22 cm

Push opening system / Sistema d'apertura push

Rails with soft closing / Guide con chiusura ammortizzata

Drawer bottom in laminated panel and matching hardware / Fondo del cassetto in pannello nobilitato e ferramenta abbinata

# Colors and finishes

atlas concorde habitat



## Bicolor



Sink Color: 01  
Colore lavabo: 01  
Drawer Unit Color: 01  
Colore cassettiera: 01



Sink Color: 02  
Colore lavabo: 02  
Drawer Unit Color: 02  
Colore cassettiera: 02



Sink Color: 03  
Colore lavabo: 03  
Drawer Unit Color: 03  
Colore cassettiera: 03



Sink Color: 04  
Colore lavabo: 04  
Drawer Unit Color: 04  
Colore cassettiera: 04



Sink Color: 10  
Colore lavabo: 10  
Drawer Unit Color: 10  
Colore cassettiera: 10

## SINK COLORS



## DRAWER UNIT COLORS



## Monocolor



Sink Color: 05  
Colore lavabo: 05  
Drawer Unit Color: 05  
Colore cassettiera: 05



Sink Color: 06  
Colore lavabo: 06  
Drawer Unit Color: 06  
Colore cassettiera: 06



Sink Color: 07  
Colore lavabo: 07  
Drawer Unit Color: 07  
Colore cassettiera: 07



Sink Color: 08  
Colore lavabo: 08  
Drawer Unit Color: 08  
Colore cassettiera: 08



Sink Color: 09  
Colore lavabo: 09  
Drawer Unit Color: 09  
Colore cassettiera: 09

## SINK COLORS

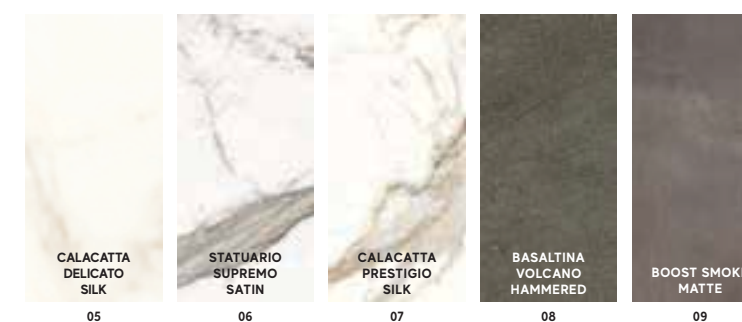

## DRAWER UNIT COLORS

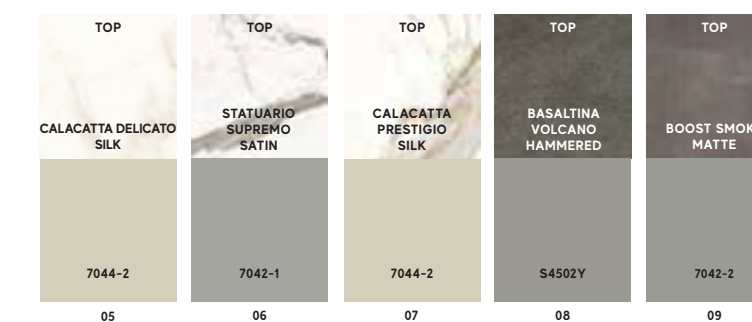

INDEX



A COMPLETE PRODUCT SYSTEM >

PRODUCT FINDER >

SURFACE RANGE >

COMPANY >

COLLECTIONS >

LARGE SIZES >

SLABS FOR COUNTERTOPS & FURNITURE >

SINKS & BATHROOM FURNISHING >

HARMONY OF SPACES  
CUSTOMIZABLE FURNISHING  
ELEMENTS  
LOOKS COLOR AND FINISHES  
PRODUCT RANGE

DIALOGO

NOTES

FACADES >

TECHNICAL SPECIFICATIONS >





© Ceramiche Atlas Concorde

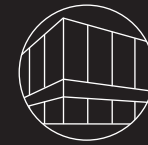

Facades

# Facades

- ◊ BEAUTY AND PERFORMANCE FOR BUILDING CLADDING
- ◊ BONDED FACADES
- ◊ VENTILATED FACADES

INDEX



A COMPLETE PRODUCT SYSTEM >

PRODUCT FINDER >

SURFACE RANGE >

COMPANY >

COLLECTIONS >

LARGE SIZES >

SLABS FOR COUNTERTOPS & FURNITURE >

SINKS & BATHROOM FURNISHING >

FACADES >

BEAUTY AND PERFORMANCE FOR BUILDING CLADDING  
BONDED FACADES  
VENTILATED FACADES

TECHNICAL SPECIFICATIONS >

# Beauty and performance for building cladding

A porcelain facade is the ideal choice for the exterior cladding of commercial and residential buildings because it combines beauty, longevity, and versatility. The ceramic material ensures complete thermal-acoustic insulation, with high levels of comfort in both the summer and winter. Its technical qualities ensure excellent resistance to fire, impacts, and weathering, so its appearance remains unchanged over time.

La facciata in gres porcellanato è la scelta ideale per il rivestimento esterno di edifici commerciali e residenziali perché coniuga bellezza, longevità e versatilità. Il materiale ceramico assicura un completo isolamento termoacustico, con elevati livelli di comfort sia in estate che in inverno. Le sue qualità tecniche garantiscono un'ottima resistenza a fuoco, urti e agenti atmosferici, così la finitura mantiene il suo aspetto immutato nel tempo.

Les façades en grès cérame sont le choix idéal pour le revêtement extérieur des bâtiments commerciaux et résidentiels, car elles allient beauté, longévité et polyvalence. Le matériau céramique assure une isolation thermique et acoustique complète, avec des niveaux de confort élevés en été comme en hiver. Ses qualités techniques assurent une excellente résistance au feu, aux chocs et aux intempéries, de sorte que la finition conserve son aspect inchangé au fil du temps.

Die Fassade aus Feinsteinzeug ist die ideale Wahl für die Außenverkleidung von Wohngebäuden und Gewerbeobjekten, denn sie ist nicht nur schön, sondern auch langlebig und vielseitig. Das Keramikmaterial bietet vollständige Wärme- und Schalldämmung und sommers wie winters ein hohes Niveau an Komfort. Seine technischen Eigenschaften garantieren hervorragende Beständigkeit gegen Feuer, Stöße und Witterung. So bleibt die Fassade auf Dauer unversehrt und schön.

Las fachadas de gres porcelánico son la opción ideal para el revestimiento exterior de edificios comerciales y residenciales porque combinan belleza, durabilidad y versatilidad. La cerámica garantiza un aislamiento termoacústico completo, con altos niveles de confort tanto en verano como en invierno. Sus cualidades técnicas garantizan una excelente resistencia al fuego, a los impactos y a los agentes atmosféricos, por lo que el acabado conserva su aspecto inalterado con el paso del tiempo.

Керамогранит – идеальный выбор для облицовки фасадов коммерческих и жилых зданий, поскольку сочетает в себе красоту, стойкость и долговечность. Этот материал обеспечивает отличную термо- и звукоизоляцию, что создает в помещениях высокий уровень комфорта как летом, так и зимой. Благодаря превосходным техническим свойствам керамогранитная облицовка обладает устойчивостью к огню, ударам, атмосферным воздействиям и сохраняет свой внешний вид неизменным в течение долгого времени.



© Ceramiche Atlas Concorde



© Ceramiche Atlas Concorde



© Ceramiche Atlas Concorde

INDEX



A COMPLETE PRODUCT SYSTEM



PRODUCT FINDER



SURFACE RANGE



COMPANY



COLLECTIONS



LARGE SIZES



SLABS FOR COUNTERTOPS & FURNITURE



SINKS & BATHROOM FURNISHING



FAÇADES



BEAUTY AND PERFORMANCE FOR BUILDING CLADDING  
BONDED FAÇADES  
VENTILATED FAÇADES

TECHNICAL SPECIFICATIONS



# Bonded facades

## On plaster



Suitable thicknesses  
± 6 mm  
± 9 mm  
± 12 mm

- 1 Stoneware cladding
- 2 Safety hook
- 3 Highly deformable adhesive
- 4 Masonry

## On thermal coat

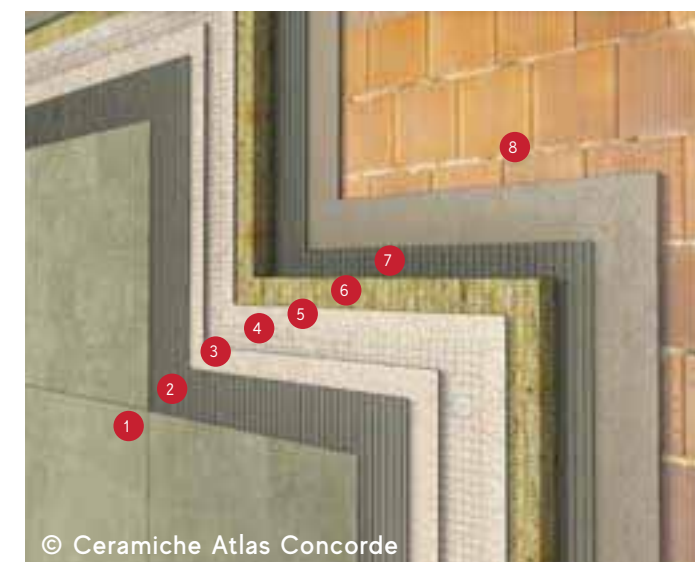

Suitable thicknesses  
± 6 mm <sup>(1)</sup>

- 1 Stoneware cladding
- 2 Highly deformable adhesive
- 3 Structural plaster
- 4 Fiber glass mesh
- 5 Structural render
- 6 Insulating panel
- 7 Adhesive
- 8 Masonry

### BONDED FACADES ON PLASTER

Porcelain panels are bonded directly to the outer plaster layer of the wall face using the double spreading method with the proper adhesive depending on the nature of the substrate, environmental conditions, and panel size. It is advisable to place metal hooks as an additional safety restraint, which will remain hidden behind the slab. These hooks are then mechanically attached to the wall.

### FACCIATE INCOLLATE SU INTONACO

I pannelli in gres vengono incollati direttamente allo strato di intonaco esterno del paramento murario, adottando il metodo della doppia spalmatura con idoneo adesivo in funzione alla natura del sottofondo, delle condizioni ambientali e del formato del pannello. È consigliabile disporre ganci metallici, come ulteriore ritegno di sicurezza, che rimarranno nascosti dietro la lastra preventivamente lavorata. Tali ganci sono poi fissati meccanicamente alla parete.

### FAÇADES À REVÊTEMENT COLLÉ SUR ENDUIT

Les panneaux en grès sont collés directement sur la couche de l'enduit extérieur du parement mural, ceci en adoptant la méthode du double encollage et en utilisant une colle appropriée selon la nature de la couche de fond, des conditions ambiantes et du format du panneau. Il est conseillé de placer des attaches métalliques, au titre de fixation ultérieure de sécurité, qui resteront cachées derrière la dalle préliminairement façonnée. Ces attaches sont ensuite mécaniquement fixées au mur.

### AUF PUTZ VERKLEBTE FASSADEN

Die Feinsteinzeugplatten werden direkt auf die externe Putzschicht der Mauer geklebt, unter beidseitigem Auftrag (Butterig-Floating-Verfahren) eines für den Untergrund, die Umgebungsbedingungen und das Plattenformat geeigneten Klebers. Es empfiehlt sich, als zusätzliche Sicherung Metallhaken anzubringen, die hinter der zuvor entsprechend bearbeiteten Platte verborgen bleiben. Diese Haken werden anschließend mechanisch an der Mauer fixiert.

### FACHADAS AMORTERADAS

Los paneles de gres se pegan directamente a la capa de yeso exterior del paramento, adoptando el método de doble distribución con un adhesivo adecuado en función de la naturaleza del sustrato, las condiciones ambientales y el tamaño del panel. Se aconseja disponer de ganchos metálicos, como sujeción adicional de seguridad, que quedarán ocultos detrás de la placa previamente procesada. Estos ganchos se fijan mecánicamente a la pared.

### ФАСАДЫ С ОБЛИЦОВКОЙ, ПРИКЛЕЕННОЙ НА ШТУКАТУРКУ

Керамогранитные панели приклеиваются непосредственно к внешнему штукатурному основанию методом двойного нанесения клея – на тыльную сторону плитки и на облицовываемое основание. Клей подбирают в зависимости от характера основания, условий окружающей среды и размера панели. В качестве дополнительного удерживающего устройства целесообразно установить на плитку металлические клеммы, которые останутся скрытыми за плитой. Затем клеммы механически крепят к стене.

### BONDED FACADES ON THERMAL COAT

External vertical cladding system made by bonding the ceramic slabs to the insulating layer using the double spreading method with the proper adhesive depending on the nature of the substrate, environmental conditions, and panel size. Light colors with a solar reflectance index (SR) greater than 20% are recommended.

### FACCIATE INCOLLATE SU CARPOTTO TERMICO

Sistema di rivestimento verticale esterno realizzato incollando le lastre ceramiche allo strato di isolante, adottando il metodo della doppia spalmatura con idoneo adesivo in funzione alla natura del sottofondo, delle condizioni ambientali e del formato del pannello. Sono da privilegiare colori chiari con indice di riflettanza solare (SR) maggiore del 20%.

### FAÇADES À REVÊTEMENT COLLÉ SUR ISOLANT THERMIQUE

Système de revêtement vertical extérieur réalisé en collant les dalles céramique sur la couche de l'isolant, ceci en adoptant la méthode du double encollage et en utilisant une colle appropriée selon la nature de la couche de fond, des conditions ambiantes et du format du panneau. Il est recommandé de privilégier les teintes claires ayant un indice de réfraction solaire (SR) supérieur à 20%.

### AN WÄRMEDÄMMVERBUNDSYSTEM VERKLEBTE FASSADEN

Außenmauer-Verkleidungssystem, bei dem die Keramikplatten auf die Dämmschicht geklebt werden, unter beidseitigem Auftrag (Butterig-Floating-Verfahren) eines für den Untergrund, die Umgebungsbedingungen und das Plattenformat geeigneten Klebers. Helle Farben mit Solar Reflectance Index (SRI) über 20 % sind zu bevorzugen.

### FACHADAS TIPO SATE

Sistema de revestimiento vertical exterior que se realiza pegando las placas cerámicas al aislamiento, adoptando el método de doble distribución con un adhesivo adecuado en función de la naturaleza del sustrato, las condiciones ambientales y el tamaño del panel. Son preferibles los colores claros con un índice de reflectancia solar (SR) superior al 20%.

### ФАСАДЫ С ОБЛИЦОВКОЙ, ПРИКЛЕЕННОЙ НА УТЕПЛИТЕЛЬ

Керамогранитные панели наклеиваются на утеплитель методом двойного нанесения клея – на тыльную сторону плитки и на облицовываемое основание. Клей подбирают в зависимости от характера основания, условий окружающей среды и размера панели. Предпочтение следует отдавать светлым цветам с коэффициентом отражения солнечного излучения (SR) более 20%.

<sup>(1)</sup> However, we do not exclude the possibility of using thicker, larger slabs on insulating layers after further evaluation at the design stage or on-site surveys in the case of work on existing surfaces. - Non si esclude comunque la possibilità di incollare su isolante in facciata lastre di spessore e formato maggiori previa ulteriori valutazioni in fase di progetto o rilevati in situ in caso di interventi su esistente. - N'exclut pas la possibilité de coller des dalles d'épaisseur et de format supérieurs sur l'isolant en façade après évaluations ultérieures en phase de projet ou après des relevés sur place en cas d'interventions sur l'existant. - Die Möglichkeit, stärkere und größere Platten auf der Außendämmschicht zu verkleben, wird nicht ausgeschlossen, hierzu sind jedoch in der Planungsphase bzw. im Fall der Sanierung vorhandener Bausubstanz bei Ortsbegehungen weitere Prüfungen erforderlich. - No obstante, no se excluye la posibilidad de pegar sobre el aislamiento en la fachada losas de mayor grosor y tamaño, a reserva de una evaluación posterior durante la fase de diseño o de estudios in situ en el caso de intervenciones existentes. - Допускается также возможность наклеивания на утеплитель плит большей толщины и формата, но только при условии проведения дополнительной оценки на этапе проектирования или детального обследования основания в случае работ на старых зданиях.

# Ventilated facades\*

## With visible mechanical hooks



© Ceramiche Atlas Concorde



© Ceramiche Atlas Concorde

Suitable thicknesses  
± 6 mm  
± 9 mm  
± 12 mm

- 1 Stoneware cladding
- 2 Clip hook
- 3 Insulating panel
- 4 Mullion
- 5 Brackets
- 6 Masonry

### VENTILATED FACADES WITH VISIBLE MECHANICAL HOOKS

The attachment of the slabs is visible and done with steel clips, possibly painted in a color similar to the facing. The metal structure of the system consists of vertical mullions and brackets anchored to the wall of the building by appropriately sized dowels. The coupling system between bracket and upright ensures compliance with the designed geometric constraints while also allowing for minor adjustment during installation.

### FAÇADES VENTILÉES À FIXATION MÉCANIQUE VISIBLE

La fixation des dalles est visible et réalisée avec des clips d'acier pouvant être peints dans le même coloris du parement. La structure métallique du système est composée de montants verticaux et d'agrafes, fixées au mur porteur du bâtiment avec des chevilles opportunément dimensionnées. Le système de fixation entre l'agrafe et le montant permet de respecter les contraintes géométriques prévues et permet d'assurer de petits ajustements en phase de pose.

### FACHADAS VENTILADAS CON ENGANCHES VISIBLES MECÁNICOS

El enganche de las losas es visible y se realiza con clips de acero, eventualmente pintados en un color similar al de la superficie. La estructura metálica del sistema está formada por montantes verticales y soportes anclados al muro portante del edificio mediante tacos de tamaño adecuado. El sistema de enganche entre el soporte y el montante permite respetar las limitaciones geométricas diseñadas, garantizando pequeños ajustes durante la colocación.

### ВЕНТИЛИРУЕМЫЕ ФАСАДЫ С ВИДИМЫМ МЕХАНИЧЕСКИМ КРЕПЛЕНИЕМ

Крепление плит выполняется с помощью стальных клеммеров, которые остаются на виду и при желании могут быть окрашены в цвет облицовки. Металлический каркас системы состоит из вертикальных профилей и кронштейнов, закрепленных на несущей стене здания с помощью дюбелей соответствующего размера. Система скрепления кронштейна и вертикального профиля позволяет соблюдать расчетные геометрические характеристики и выполнять незначительные корректировки при монтаже.

## With invisible mechanical hooks



© Ceramiche Atlas Concorde

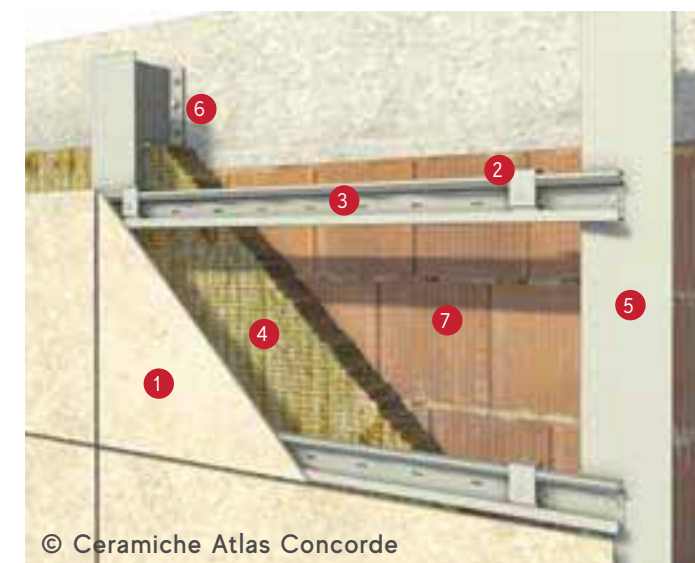

© Ceramiche Atlas Concorde

Suitable thicknesses  
± 9 mm  
± 12 mm  
± 20 mm



- 1 Stoneware cladding
- 2 Fasteners
- 3 Horizontal profile
- 4 Insulating panel
- 5 Mullion
- 6 Brackets
- 7 Masonry

### VENTILATED FACADES WITH INVISIBLE MECHANICAL HOOKS

The attachment is concealed on the back of the slab by means of special steel inserts that fit into previously-made holes. The metal structure of the system consists of vertical mullions, horizontal beams, and brackets anchored to the wall of the building by appropriately sized dowels. The coupling system between bracket and upright ensures compliance with the designed geometric constraints while also allowing for minor adjustments during installation.

### FAÇADES VENTILÉES À FIXATION MÉCANIQUE INVISIBLE

La fixation est cachée au dos de la dalle grâce à des inserts d'acier particuliers qui sont insérés dans des échancrures, précédemment réalisées mécaniquement. La structure métallique du système est composée de montants verticaux, de longerons horizontaux et d'agrafes, fixés au mur porteur du bâtiment à l'aide de chevilles opportunément dimensionnés. Le système de fixation entre l'agrafe et le montant permet de respecter les contraintes géométriques prévues et permet d'assurer de petits ajustements en phase de pose.

### FASSADEN MIT VERDECKTEN MECHANISCHEN HAKEN

Der Haken befindet sich verdeckt an der Plattenrückseite; hierzu werden Spezial-Stahleinsätze in zuvor angebrachte Reflektanten eingefügt. Die Metallstruktur des Systems besteht aus senkrechten und waagerechten Profilen und Klammern, die mit entsprechend bemessenen Dübeln an der tragenden Mauer verankert werden. Das Verankerungssystem zwischen Klammer und Profil erlaubt die Einhaltung der geometrischen Projektvorgaben und lässt bei der Installation kleine Korrekturen zu.

### FACHADAS VENTILADAS CON ENGANCHES OCULTOS MECÁNICOS

El enganche está oculto detrás de la losa mediante unos insertos de acero especiales que encajan en los agujeros socavados, realizados previamente de forma mecánica. a estructura metálica del sistema está formada por montantes verticales, vigas horizontales y soportes, anclados al muro portante del edificio mediante tacos de tamaño adecuado. El sistema de enganche entre el soporte y el montante permite respetar las limitaciones geométricas diseñadas, garantizando pequeños ajustes durante la colocación.

### ВЕНТИЛИРУЕМЫЕ ФАСАДЫ СО СКРЫТЫМ МЕХАНИЧЕСКИМ КРЕПЛЕНИЕМ

Крепление выполняется с помощью цанговых стальных анкеров, которые вставляются в глухие отверстия с подрезкой на тыльной стороне плит и не видны снаружи. Металлический каркас системы состоит из вертикальных и горизонтальных профилей и кронштейнов, закрепленных на несущей стене здания с помощью дюбелей соответствующего размера. Система скрепления кронштейна и вертикального профиля позволяет соблюдать расчетные геометрические характеристики и выполнять незначительные корректировки при монтаже.

\* Technological exterior cladding systems consisting of a series of layers anchored to the building walls by a metal structure. A layer of thermal and acoustic insulation is usually applied directly on the wall, and then porcelain tile cladding is added externally. A hollow space is created between the two layers to ensure the breathability of the facade through continuous ventilation. - Sistemi tecnologici di rivestimento esterno costituiti da una serie di strati ancorati alle pareti dell'edificio mediante una struttura metallica. A contatto con la parete in genere è applicato uno strato di isolante termico ed acustico e più esternamente il rivestimento in gres porcellanato. Tra i due strati si crea un'intercapedine vuota che garantisce traspirazione della facciata mediante ventilazione continua. - Systèmes technologiques de revêtement extérieur constitués d'une série de couches ancrées aux murs du bâtiment à l'aide d'une structure métallique. Une couche d'isolant thermique et phonique est généralement appliquée sur le mur, puis le revêtement en grès cérame sur la partie la plus extérieure. Un espace vide se crée entre les deux couches, laissant ainsi la façade respirer par ventilation continue. - Technische Außenverkleidungssysteme, bestehend aus einer Reihe von mit einer Metallstruktur an der Gebäudemauer verankerten Schichten. An der Mauer anliegend wird in der Regel eine Wärme- und Schalldämmschicht verlegt, und an der Außenseite die Verkleidung. Zwischen den beiden Schichten entsteht ein Hohlraum, der die Fassade durch kontinuierliche Belüftung atmen lässt. - Sistemas tecnológicos de revestimiento exterior que consisten en una serie de capas ancladas a las paredes del edificio mediante una estructura metálica. En contacto con la pared, se suele aplicar una capa de aislamiento térmico y acústico, y más externamente el revestimiento de gres porcelánico. Se crea una cavidad vacía entre las dos capas para garantizar la transpiración de la fachada mediante una ventilación continua. - Системы наружной облицовки, состоящие из нескольких слоев, закрепленных на стенах здания с помощью металлического каркаса. В контакте со стеной обычно устанавливается слой тепло- и звукоизоляции, а снаружи - облицовка из керамогранита. Между этими двумя слоями образуется зазор, который обеспечивает удаление избыточной влаги из стены за счет вентилирования постоянным потоком воздуха.

# Ventilated facades\*

## With invisible chemical-mechanical hooks



© Ceramiche Atlas Concorde

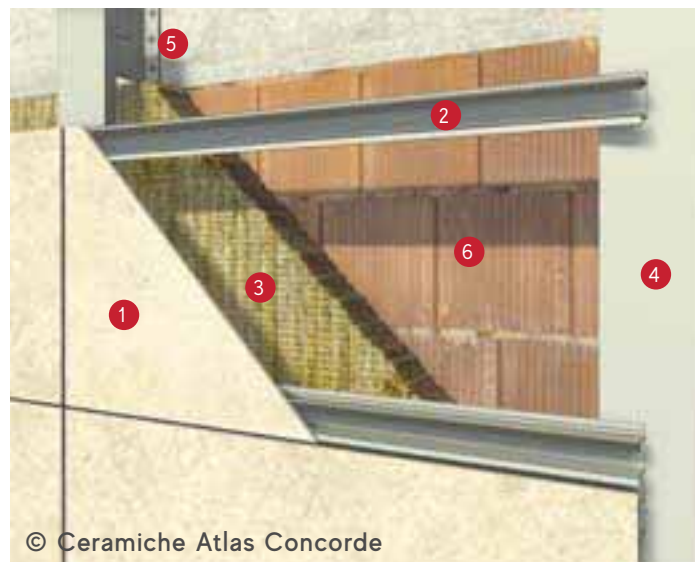

© Ceramiche Atlas Concorde

Suitable thicknesses  
 ± 6 mm  
 ± 9 mm  
 ± 12 mm

- 1 Stoneware cladding
- 2 Horizontal profile
- 3 Insulating panel
- 4 Mullion
- 5 Brackets
- 6 Masonry

### VENTILATED FACADES WITH INVISIBLE CHEMICAL-MECHANICAL HOOKS

For slabs less than 9 mm thick, the attachment system is not only mechanical but also chemical. Depending on the case, the bonding can be continuous and applied to a backing layer or directly to the metal profiles of the structure. The hybrid nature of the attachment thus provides greater safety than single-attachment techniques.

### FACCIATE VENTILATE CON AGGANCI A SCOMPARSA CHIMICO-MECCANICI

Per lastre di spessore inferiore a 9 mm, il sistema di aggancio non sarà esclusivamente meccanico ma anche chimico. A seconda dei casi l'incollaggio può essere continuo e applicato ad uno strato di supporto oppure direttamente ai profili metallici della struttura. La natura ibrida dell'aggancio garantisce così maggior sicurezza rispetto ad agganci con tecnica di fissaggio singola.

### FAÇADES VENTILÉES À FIXATION CHIMICO-MÉCANIQUE INVISIBLE

Pour les dalles de moins de 9 mm d'épaisseur, le système de fixation ne sera pas uniquement mécanique mais également chimique. Selon le cas, l'encollage peut être continu et appliqué à une couche de support ou directement aux profils métalliques de la structure. La nature hybride de la fixation garantit ainsi une plus grande sécurité par rapport aux techniques à fixation simple.

### FASSADEN MIT VERDECKTEN HAKEN UND CHEMISCH-MECHANISCHER BEFESTIGUNG

Bei Platten mit weniger als 9 mm Stärke erfolgt die Befestigung nicht nur mechanisch, sondern auch chemisch. Je nach Bedarf kann die Verklebung durchgehend erfolgen; der Kleber kann auf eine Trägerschicht oder direkt auf die Metallprofile der Struktur aufgetragen werden. Die zweifache Verankerung garantiert größere Sicherheit als jene mit nur einem Befestigungssystem.

### FACHADAS VENTILADAS CON ENGANCHES OCULTOS QUÍMICO-MECÁNICOS

En el caso de las losas de menos de 9 mm de grosor, el sistema de enganche no será solo mecánico, sino también químico. Según el caso, la adhesión puede ser continua y aplicarse a una capa de soporte o directamente a los perfiles metálicos de la estructura. La naturaleza híbrida del enganche garantiza así una mayor seguridad en comparación con los enganches con una única técnica de fijación.

### ВЕНТИЛИРУЕМЫЕ ФАСАДЫ СО СКРЫТЫМ ХИМИКО-МЕХАНИЧЕСКИМ КРЕПЛЕНИЕМ

Для плит толщиной менее 9 мм система крепления должна быть не только механической, но и химической. В зависимости от случая, химический анкер может наноситься сплошным слоем на несущее основание или непосредственно на металлические профили каркаса. Смешанный способ обеспечивает большую надежность крепления, по сравнению с одинарным.

## With invisible hooks for slabs with incisions (kerf)



© Ceramiche Atlas Concorde

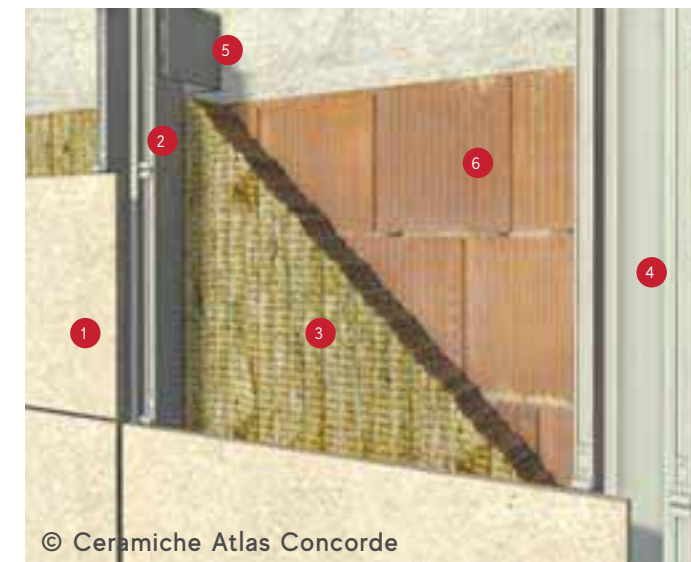

© Ceramiche Atlas Concorde

Suitable thicknesses  
 ± 20 mm



- 1 Stoneware cladding
- 2 Clip hook
- 3 Insulating panel
- 4 Mullion
- 5 Brackets
- 6 Masonry

### VENTILATED FACADES WITH INVISIBLE HOOKS FOR SLABS WITH INCISIONS (KERF)

For 20-mm-thick slabs, the concealed attachment system consists of clips inserted into an incision on the edge of the slabs, previously cut into the thickness along the parallel horizontal sides with respect to the orientation of the installation. The structure can be the same as the systems with visible fasteners.

### FACCIATE VENTILATE CON AGGANCI A SCOMPARSA PER LASTRE INTAGLIATE (KERF)

Per lastre di spessore 20 mm il sistema di aggancio occulto è costituito da clips inserite in una incisione sulla costa delle lastre, preventivamente incise nello spessore lungo i lati paralleli orizzontali rispetto all'orientamento dell'installazione. La struttura può essere la stessa dei sistemi con aggancio a vista.

### FAÇADES VENTILÉES À FIXATION INVISIBLE POUR DALLES RAINURÉES (KERF)

Pour les dalles de 20 mm d'épaisseur, le système de fixation invisible est constitué de clips insérés dans une rainure dans la tranche des dalles, lesquelles sont préalablement rainurées dans l'épaisseur le long des bords horizontaux parallèles par rapport à l'orientation de l'installation. La structure peut être la même des systèmes à fixation visible.

### HINTERLÜFTETE FASSADEN MIT VERDECKTEN HAKEN FÜR PLATTEN MIT SCHLITZEN (KERF)

Für 20 mm starke Platten besteht das System der verdeckten Befestigung aus Clips, die in Schlitze an der Plattenkante eingesetzt werden. Dieser werden zuvor an den nach Installationschema waagerechten Parallelseiten eingeschnitten. Die Struktur kann dieselbe sein wie jene für Sichthaken.

### VENTILADAS CON ENGANCHES OCULTOS PARA LOSAS TALLADAS (KERF)

Para las losas de 20 mm de grosor, el sistema de enganche oculto consiste en clips insertados en una incisión en el borde de las losas, previamente incisa en el grosor a lo largo de los lados paralelos horizontales con respecto a la orientación de la instalación. La estructura puede ser la misma que la de los sistemas de enganche visible.

### ВЕНТИЛИРУЕМЫЕ ФАСАДЫ СО СКРЫТЫМ КРЕПЛЕНИЕМ ДЛЯ ПЛИТ С ПРОПИЛОМ

Для плит толщиной 20 мм скрытое крепление выполняется с помощью кляммеров, которые заводятся в пропилов, выполненный по параллельным горизонтальным торцам относительно направления монтажа. Каркас может быть таким же, как и для видимого крепления.

\* Technological exterior cladding systems consisting of a series of layers anchored to the building walls by a metal structure. A layer of thermal and acoustic insulation is usually applied directly on the wall, and then porcelain tile cladding is added externally. A hollow space is created between the two layers to ensure the breathability of the facade through continuous ventilation. - Sistemi tecnologici di rivestimento esterno costituiti da una serie di strati ancorati alle pareti dell'edificio mediante una struttura metallica. A contatto con la parete in genere è applicato uno strato di isolante termico ed acustico e più esternamente il rivestimento in gres porcellanato. Tra i due strati si crea un'intercapedine vuota che garantisce traspirazione della facciata mediante ventilazione continua. - Systèmes technologiques de revêtement extérieur constitués d'une série de couches ancrées aux murs du bâtiment à l'aide d'une structure métallique. Une couche d'isolant thermique et phonique est généralement appliquée sur le mur, puis le revêtement en grès cérame sur la partie la plus extérieure. Un espace vide se crée entre les deux couches, laissant ainsi la façade respirer par ventilation continue. - Technische Außenverkleidungssysteme, bestehend aus einer Reihe von mit einer Metallstruktur an der Gebäudemauer verankerten Schichten. An der Mauer anliegend wird in der Regel eine Wärme- und Schalldämmschicht verlegt, und an der Außenseite die Verkleidung. Zwischen den beiden Schichten entsteht ein Hohlraum, der die Fassade durch kontinuierliche Belüftung atmen lässt. - Sistemas tecnológicos de revestimiento exterior que consisten en una serie de capas ancladas a las paredes del edificio mediante una estructura metálica. En contacto con la pared, se suele aplicar una capa de aislamiento térmico y acústico, y más externamente el revestimiento de gres porcelánico. Se crea una cavidad vacía entre las dos capas para garantizar la transpiración de la fachada mediante una ventilación continua. - Системы наружной облицовки, состоящие из нескольких слоев, закрепленных на стенах здания с помощью металлического каркаса. В контакте со стеной обычно устанавливается слой тепло- и звукоизоляции, а снаружи - облицовка из керамогранита. Между этими двумя слоями образуется зазор, который обеспечивает удаление избыточной влаги из стены за счет вентилирования постоянным потоком воздуха.





## Technical Specifications

- ⇨ CERTIFICATIONS
- ⇨ TECHNICAL FEATURES
- ⇨ SENSITECH TECHNOLOGY
- ⇨ ANTI-SLIP CLASSIFICATION
- ⇨ LAYING SUGGESTIONS, CLEANING AND MAINTENANCE
- ⇨ PACKING
- ⇨ GENERAL SALES CONDITIONS

INDEX



A COMPLETE PRODUCT SYSTEM



PRODUCT FINDER



SURFACE RANGE



COMPANY



COLLECTIONS



LARGE SIZES



SLABS FOR COUNTERTOPS & FURNITURE



SINKS & BATHROOM FURNISHING



FACADES



TECHNICAL SPECIFICATIONS



# Certifications

Atlas Concorde has a certified system for the management of company functions and processes, achieving increasingly efficient levels of internal organisation, traceability, identification of critical issues, problems and best practices. The concept of safety concerns all functions, most often crosswise in relation to the different tasks and activities.

Atlas Concorde dispone di un sistema certificato per la gestione delle funzioni e dei processi aziendali che consente livelli sempre più efficienti di organizzazione interna, tracciabilità, individuazione di criticità, problematiche e best practices. Il concetto di sicurezza riguarda tutte le funzioni, il più delle volte in modo trasversale rispetto alle diverse mansioni e attività.

Atlas Concorde dispose d'un système certifié de gestion des fonctions et processus d'entreprise qui assure des niveaux de plus en plus efficaces d'organisation interne, de traçabilité, d'identification des points critiques, des problèmes et des bonnes pratiques. La notion de sécurité touche toutes les fonctions, le plus souvent de manière transversale par rapport aux différentes fonctions et activités.

Atlas Concorde verfügt über ein zertifiziertes System für das Management von Unternehmensfunktionen und -prozessen, das eine immer effizientere interne Organisation, Rückverfolgbarkeit, Identifizierung von kritischen Fragen, Problemen und bewährten Verfahren ermöglicht. Das Sicherheitskonzept bezieht sich auf alle Funktionen, am häufigsten auf die verschiedenen Aufgaben und Tätigkeiten.

Atlas Concorde cuenta con un sistema certificado para la gestión de las funciones y los procesos de la empresa, que permite alcanzar niveles cada vez más eficientes de organización interna, trazabilidad y detección de puntos críticos, incidencias, así como buenas prácticas. El concepto de seguridad concierne todas las funciones, la mayoría de las veces de forma transversal respecto a las distintas tareas y actividades.

Atlas Concorde располагает сертифицированной системой управления корпоративными функциями и процессами, которая позволяет постоянно повышать эффективность внутренней организации, отслеживаемость продукции, уровень выявления критических и текущих проблем и внедрения передовых практик. Концепция безопасности касается всех функций и в большинстве случаев поперечно проходит через различные должностные обязанности и виды деятельности.

## Certifications

### Company / Azienda



### Product / Prodotto



### Product "Declarations" / Dichiarazioni di prodotto



UPEC PORCELAIN TILES	
AIX	LIMS
AXI	MARVEL
BLAZE	MARVEL DREAM
BOOST	MARVEL EDGE
BOOST PRO	MARVEL GEMS
BOOST NATURAL	MARVEL SHINE
BOOST STONE	MARVEL PRO
BRAVE	MARVEL STONE
DWELL	NID (15x90 cm)
ETIC	PRISM
ETIC PRO (22,5x90 cm)	TRUST
EXENCE (20x120 cm)	VENTI BOOST
HEARTWOOD (20x120 cm)	
KONE	

## Certifications for export to international markets\*



SQM  
SAUDI ARABIA

SGS  
INDONESIA



UPEC F+ OUTDOOR ≥ 20 MM
BLAZE
BOOST
BOOST PRO
BRAVE
TRUST

CLASSIFICATION UPEC/UPEC F+ EN COURS DE CERTIFICATION
BOOST MIX
BOOST NATURAL (UPEC F+)
BOOST STONE (UPEC F+)
NORDE (UPEC F+)
MARVEL TRAVERTINE
MARVEL X

\* Shipments can be made in accordance with national requirements anywhere in the world, even in markets with complex customs procedures such as Egypt, Morocco and Kurdistan, thanks to our active cooperation with accredited certification bodies in each country. - Possibilità di spedizioni conformi alle prescrizioni nazionali ovunque nel mondo, anche in mercati con procedure doganali complesse come Egitto, Marocco, Kurdistan, grazie alla collaborazione sempre attiva con gli enti di certificazione accreditati in ciascun paese. - Dank unserer aktiven Zusammenarbeit mit den akkreditierten Zertifizierungsstellen in den einzelnen Ländern können die Sendungen in Übereinstimmung mit den nationalen Anforderungen überall auf der Welt versandt werden, selbst auf Märkten mit komplexen Zollverfahren wie Ägypten, Marokko und Kurdistan. - Possibilità d'expéditions conformes aux prescriptions nationales partout dans le monde, même sur les marchés dont les procédures douanières sont complexes comme l'Égypte, le Maroc ou le Kurdistan, grâce à la collaboration toujours active avec les organismes de certification homologués dans chaque pays. - Se pueden realizar envíos según la normativa nacional a cualquier parte del mundo, incluso a mercados con procedimientos aduaneros complejos como Egipto, Marruecos o Kurdistan, gracias a la cooperación permanente con los organismos de certificación acreditados en cada país. - Компания имеет возможность осуществлять поставки в любую точку мира в соответствии с национальными требованиями, даже на рынках со сложными таможенными процедурами, таких как Египет, Марокко, Курдистан, благодаря неизменно активному сотрудничеству с аккредитованными органами сертификации в каждой стране.

UPEC Classificazione aggiornata al - Classement UPEC mis à jour au: 2023

Si consiglia la consultazione della pagina - On vous conseille de vous connecter à: <https://database.cspb.fr/holderdetails?Uid=ETB-2094&AppRef=QB32>

Per ulteriori informazioni scrivere a - Pour tous renseignements complémentaires merci d'écrire à: [france@atlasconcorde.it](mailto:france@atlasconcorde.it)



# Porcelain Tiles

## Technical Specification

Complies with	EN 14411 (ISO 13006)	Appendix	G	Group	Bla
Conforme alla norma	EN 14411 (ISO 13006)	Appendice	G	Gruppo	Bla
Conforme à la norme	EN 14411 (ISO 13006)	Appendice	G	Groupe	Bla
Entsprechend	EN 14411 (ISO 13006)	Anhang	G	Gruppe	Bla
Conforme a la norma	EN 14411 (ISO 13006)	Apéndice	G	Grupo	Bla
Соответствует норме	EN 14411 (ISO 13006)	Приложение	G	Группа	Bla

- (\*) **The permissible deviation, in % or mm, of the average size for each tile (2 or 4 sides) from work size (WS).**  
Deviazione ammissibile, in % oppure mm, della dimensione media di ogni piastrella (2 oppure 4 lati) dalla dimensione di fabbricazione (WS).
- (\*\*) **The permissible deviation, in % or mm, of the average thickness for each tile from the work size thickness (WS).**  
Deviazione ammissibile, in % oppure mm, dello spessore medio di ogni piastrella dallo spessore riportato nella dimensione di fabbricazione (WS).
- (\*\*\*) **The maximum permissible deviation from straightness, in % or mm, related to the corresponding work sizes (WS).**  
Deviazione massima ammissibile di rettilineità, in % oppure mm, in rapporto alle dimensioni di fabbricazione (WS) corrispondenti.
- (\*\*\*\*) **The maximum permissible deviation from rectangularity, in % or mm, related to the corresponding work sizes (WS).**  
Deviazione massima ammissibile di ortogonalità, in % oppure mm, in rapporto alle dimensioni di fabbricazione (WS) corrispondenti.
- c.c. **The maximum permissible deviation from centre curvature, in % or mm, related to diagonal calculated from the work sizes (WS).**  
Deviazione massima ammissibile della curvatura del centro, in % oppure mm, in rapporto alla diagonale calcolata secondo le dimensioni di fabbricazione (WS).
- e.c. **The maximum permissible deviation from edge curvature, in % or mm, related to the corresponding work sizes (WS).**  
Deviazione massima ammissibile della curvatura dello spigolo, in % oppure mm, in rapporto alle dimensioni di fabbricazione (WS) corrispondenti.
- w. **The maximum permissible deviation from warpage, in % or mm, related to diagonal calculated from the work sizes (WS).**  
Deviazione massima ammissibile dello svergolamento, in % oppure mm, in rapporto alla diagonale calcolata secondo le dimensioni di fabbricazione (WS).
- (1) **Determination of slip resistance of pedestrian surfaces; it does not cover sports surfaces and road surfaces for vehicles (skid resistance).**  
Determinazione della resistenza allo scivolamento delle superfici pedonabili; non si applica alle pavimentazioni sportive ed alle pavimentazioni stradali veicolari.
- (2) **Anti-slip performance is guaranteed at the time of delivery of the product.**  
Le prestazioni anti-slip vengono garantite al momento della consegna del prodotto.
- (3) **However, tiles with a DCOF of 0.42 or greater are not necessarily suitable for all projects. The specifier shall determine tiles appropriate for specific project conditions, considering by way of example, but not in limitation, type of use, traffic, expected contaminants, expected maintenance, expected wear, and manufacturers' guidelines and recommendations.**
- (4) **For further details, please refer to outdoor design general catalogue.** Per maggiori informazioni riferirsi al catalogo generale Outdoor Design.
- (5) **Only for products with 20 mm thickness. Solo per prodotti a 20mm di spessore.**



A COMPLETE  
PRODUCT  
SYSTEM



PRODUCT  
FINDER



SURFACE  
RANGE



COMPANY



COLLECTIONS



LARGE SIZES



SLABS FOR  
COUNTERTOPS  
& FURNITURE



SINKS &  
BATHROOM  
FURNISHING



FACADES



TECHNICAL  
SPECIFICATIONS



### Technical feature symbols

			<p><b>Length and width</b> / Lunghezza e larghezza / Longuer et largeur / Länge und Breite / Longitud y anchura / Размеры сторон (*)</p> <p><b>Thickness</b> / Spessore / Epaisseur / Stärke / Grosor / Толщина (**)</p> <p><b>Straightness of sides</b> / Rettilineità degli spigoli / Rectitude des arêtes / Kantengeradheit / Rectilineidad de las aristas / Кривизна сторон (***)</p> <p><b>Rectangularity</b> / Ortogonalità / Orthogonalité / Rechtwinkligkeit / Ortogonalidad / Косоугольность (****)</p> <p><b>(Measurement only on short edges when L/l ≥ 3)</b> (Misurazione da condurre solo sui lati corti quando L/l ≥ 3) (Ne mesurez que les côtés courts lorsque L/l ≥ 3) (Messung nur an den kurzen Seiten, wenn L/l ≥ 3) (Medir solo en los lados cortos cuando L/l ≥ 3) (Измерение проводится только на короткой грани, когда L/l ≥ 3)</p>
<b>Regularity characteristics</b> Caratteristiche di regolarità Caractéristiques de régularité Regelmäßigkeit Características de regularidad Свойства правильности	ISO 10545-2		
			<p><b>Surface flatness</b> / Planarità / Planimetrie / Ebenflächigkeit / Planaridad / Кривизна лицевой поверхности</p> <p>c.c.</p> <p>e.c.</p> <p>ws.</p>
<b>Structural characteristics</b> Caratteristiche strutturali Caractéristiques structureales Strukturelle Eigenschaften Características estructurales Конструктивные свойства	ISO 10545-3		<p><b>Water absorption (in % by mass)</b> / Massa d'acqua assorbita (come % della massa) / Masse d'eau absorbée (en % de la masse) / Aufgenommene Wassermasse (in % der Masse) / Peso de agua absorbida (como % de la masa) / Водопоглощение (% от массы)</p>
	ASTM C373-18		
<b>Bulk mechanical characteristics</b> Caratt. meccaniche massive Caractéristiques mécaniques massives Mechanische Eigenschaften des Scherben Características mecánicas Механические свойства массы	ISO 10545-4		<p><b>Breaking strength</b> / Sforzo di rottura / Force de rupture / Bruchlast / Esfuerzo de ruptura / Усилие на излом</p> <p><b>Modulus of rupture</b> / Resistenza alla flessione / Résistance à la flexion / Biegefestigkeit / Resistencia a la flexión / Устойчивость к изгибу</p>
	EN 1339 Annex F		<p><b>Bending strength and breaking load</b> / Resistenza a flessione e al carico di rottura / Résistance à la flexion et à la charge de rupture / Biege- und Bruchfestigkeit / Extraordinaria resistencia a la flexión y a la carga de rotura / Предел прочности при изгибе и разрушающая нагрузка</p> <p>(4)(5)</p>
	ISO 10545-5		<p><b>Impact resistance, as coefficient of restitution</b> / Resistenza all'impatto, espresso come coefficiente di restituzione / Résistance au choc, par mesurage du coefficient de restitution / Schlagzähigkeit, ausgedrückt als Restitutionskoeffizient / Resistencia al impacto, expresada como coeficiente de restitución / Ударпрочность, выраженная коэффициентом восстановления</p>
<b>Surface mechanical characteristics</b> Caratt. meccaniche superficiali Caractéristiques mécaniques superficielles Mechanische Eigenschaften der Oberfläche Características mecánicas superficiales Поверхностные механические свойства	ISO 10545-6		<p><b>Resistance to deep abrasion of unglazed tiles (removed volume)</b> / Resistenza all'abrasione profonda delle piastrelle non smaltate (volume materiale asportato) / Résistance à l'abrasion profonde des carreaux non émaillés (volume du matériau retiré) / Widerstand gegen Tiefenverschleiß von unglasierten Fliesen (Materialabtrag bzw. Volumenverlust) / Resistencia a la abrasión profunda de las baldosas no esmaltadas (volumen material extraído) / Стойкость к глубокому истиранию неглазурованных плиток (объем удаленного материала)</p>
	ISO 10545-8		<p><b>Coefficient of thermal linear expansion</b> / Coefficiente di dilatazione termica lineare / Coefficient de dilatation thermique linéique / Lineare thermische Dehnung / Coeficiente de dilatación térmica lineal / Коэффициент линейного расширения</p>
	ISO 10545-9		<p><b>Thermal shock resistance</b> / Resistenza agli sbalzi termici / Résistance aux écarts de température / Temperaturwechselbeständigkeit / Resistencia a los cambios de temperatura / Устойчивость к перепаду температур</p>
	ISO 10545-10		<p><b>Moisture expansion (in mm/m)</b> / Dilatazione all'umidità (in mm/m) / Dilatation à l'humidité (en mm/m) / Feuchtigkeitsausdehnung (in mm/m) / Dilatación por la humedad (en mm/m) / Расширение под воздействием влаги (в мм/м)</p>
<b>Physical properties</b> Proprietà fisiche Propriétés physiques Physikalische Eigenschaften Propiedades físicas Физические характеристики	EN 1348		<p><b>Bond strength/adhesion for improved cementitious adhesives</b> / Adesione a trazione con adesivi cementizi migliorati / Adhérence par traction avec des ciments-colle améliorés / Scherfestigkeit mit verbesserten zementhaltigen Klebern / Adherencia a tracción con adhesivos cementosos mejorados / Прочность на растяжение при приклеивании улучшенными цементными клеями</p>
	-		<p><b>Reaction to fire</b> / Reazione al fuoco / Réaction au feu / Brandverhalten / Reacción al fuego / Огнестойкость</p>
<b>Chemical characteristics</b> Caratteristiche chimiche Caractéristiques chimiques Chemische Eigenschaften Características químicas Химические свойства	ISO 10545-13		<p><b>Resistance to household chemicals and swimming pool salts</b> / Resistenza ai prodotti chimici di uso domestico ed agli additivi per piscina / Résistance aux produits chimiques à usage domestique et aux adjuvants pour piscine / Beständigkeit gegen Haushaltschemikalien und Badewasserzusätze / Resistencia a los productos químicos de uso doméstico / Стойкость к химикатам, используемым в быту и для бассейнов</p> <p><b>Resistance to low concentrations of acids and alkalis</b> / Resistenza a basse concentrazioni di ACIDI e ALCALI / Résistance aux acides et aux alcalis à basse concentration / Beständigkeit gegen niedrigkonzentrierte Säuren und Laugen / Resistencia a los ácidos y bases de baja concentración / Сопротивление кислотам и щелочам низкой концентрации</p> <p><b>Resistance to high concentrations of acids and alkalis</b> / Resistenza ad alte concentrazioni di ACIDI e ALCALI / Résistance aux acides et aux alcalis à haute concentration / Beständigkeit gegen hochkonzentrierte Säuren und Laugen / Resistencia a los ácidos y bases de alta concentración / Сопротивление кислотам и щелочам высокой концентрации</p>
	ISO 10545-14		<p><b>Resistance to staining, for unglazed tiles</b> / Resistenza alle macchie per piastrelle non smaltate / Résistance aux taches pour carreaux non émaillés / Widerstand gegen Fleckenbildung für unglasierte Fliesen / Resistencia a las manchas para azulejos no esmaltados / Устойчивость к загрязнению, для неглазурованных плиток</p>
	DIN EN 16165 ANNEX B (EX DIN 51130)		<p><b>Shod Ramp Test</b> / Metodo della rampa "calzato" / Test de la rampe « chaussé » / Rampenmethode mit Schuhen / Método de la rampa "calzado" / Метод наклонной плоскости (в обуви)</p>
DIN EN 16165 ANNEX A (EX DIN 51097)		<p><b>Barefoot Ramp Test</b> / Metodo della rampa a piedi nudi / Test de la rampe à pieds nus / Rampenmethode barfuß / Método de la rampa a pies descalzos / Метод наклонной плоскости (босыми ногами)</p> <p>(1)(2)</p>	
BS EN 16165 ANNEX C (EX BS 7976)		<p><b>Pendulum Friction Test</b> / Metodo del Pendolo / Méthode du Pendule / Pendelmethode / Método del péndulo / Метод маятника</p> <p>(1)(2)</p>	
AS 4586			
UNE 41901 EX 2017			
B.C.R.A. Rep. CEC/81			<p><b>Coefficient of friction (COF)</b> / Coefficiente di attrito / Coefficient de frottement / Reibungskoeffizient / Coeficiente de roce / Коэффициент трения</p> <p>(1)(2)</p>
ANSI A 326.3			<p><b>Dynamic coefficient of friction (DCOF)</b> / Coefficiente di attrito dinamico / Coefficient de frottement dynamique / Dynamischer Reibungskoeffizient / Coeficiente de roce dinámico / Динамический коэффициент трения</p> <p>(1)(2)(3)</p>

### Porcelain tiles technical features

		Requirements for nominal size N Requisiti per dimensione nominale N			AIX			AXI		BLAZE	
		7 cm ≤ N < 15 cm (mm)	N ≥ 15 cm (%) (mm)		Matte Senstech ± 9 mm	Grip ± 9 mm	Outdoor ± 20 mm	Matte ± 9 mm	Matte ± 9 mm		
Regularity characteristics	Length and width Lunghezza e larghezza	± 0,9 (*) Non-rect. ± 0,4 (*) Rect.	± 0,6 (*) Non-rect. ± 0,3 (*) Rect.	± 2,0 (*) Non-rect. ± 1,0 (*) Rect.	Suitable for Conforme	Suitable for Conforme	Suitable for Conforme	Suitable for Conforme	Suitable for Conforme		
	Thickness Spessore	± 0,5 (**)	± 5 (**)	± 0,5 (**)	Suitable for Conforme	Suitable for Conforme	Suitable for Conforme	Suitable for Conforme	Suitable for Conforme		
	Straightness of sides Rettilineità degli spigoli	± 0,8 (***) Non-rect. ± 0,4 (***) Rect.	± 0,5 (***) Non-rect. ± 0,3 (***) Rect.	± 1,5 (***) Non-rect. ± 0,8 (***) Rect.	Suitable for Conforme	Suitable for Conforme	Suitable for Conforme	Suitable for Conforme	Suitable for Conforme		
	Rectangularity (Measurement only on short edges when L/l ≥ 3) Ortogonalità (Misurazione da condurre solo sui lati corti quando L/l ≥ 3)	± 0,8 (****) Non-rect. ± 0,4 (****) Rect.	± 0,5 (****) Non-rect. ± 0,3 (****) Rect.	± 2,0 (****) Non-rect. ± 1,5 (****) Rect.	Suitable for Conforme	Suitable for Conforme	Suitable for Conforme	Suitable for Conforme	Suitable for Conforme		
Surface flatness	Surface flatness Planarità	c.c. ± 0,8 Non-rect. c.c. ± 0,6 Rect.	c.c. ± 0,5 Non-rect. c.c. ± 0,4 Rect.	c.c. ± 2,0 Non-rect. c.c. ± 1,8 Rect.	Suitable for Conforme	Suitable for Conforme	Not applicable to "strong" structures Non applicabile a strutturati forti	Suitable for Conforme	Suitable for Conforme		
	Water absorption (in % by mass) Massa d'acqua assorbita (come % della massa)	E <sub>s</sub> ≤ 0,5% Individual max 0,6% E <sub>s</sub> ≤ 0,5% Valore max singolo 0,6%			≤ 0,1%	≤ 0,1%	≤ 0,1%	≤ 0,1%	≤ 0,1%		
		Requirement ANSI A137.1 Water Absorption Max ≤ 0,5%			≤ 0,5%	≤ 0,5%	≤ 0,5%	≤ 0,5%	≤ 0,5%		
		S ≥ 700N (for thickness < 7,5 mm - per spessore < 7,5 mm) S ≥ 1300N (for thickness ≥ 7,5 mm - per spessore ≥ 7,5 mm)	S ≥ 1500 N	S ≥ 1500 N	S ≥ 10000 N	S ≥ 2000 N	S ≥ 1500 N				
Bulk mechanical characteristics	Modulus of rupture Resistenza alla flessione	R ≥ 40 N/mm <sup>2</sup>	R ≥ 40 N/mm <sup>2</sup>	R ≥ 45 N/mm <sup>2</sup>	R ≥ 40 N/mm <sup>2</sup>	R ≥ 40 N/mm <sup>2</sup>	R ≥ 45 N/mm <sup>2</sup>	R ≥ 40 N/mm <sup>2</sup>	R ≥ 45 N/mm <sup>2</sup>		
	Bending strength and breaking load Resistenza a flessione e al carico di rottura (4)(5)	-	-	≥ U4 60x90	-	-					
	Impact resistance, as coefficient of restitution Resistenza all'impatto, espresso come coefficiente di restituzione	ISO 10545-5	Declared value Valore dichiarato	≥ 0,55	≥ 0,55	≥ 0,55	≥ 0,55	≥ 0,55	≥ 0,55		
	Resistance to deep abrasion of unglazed tiles (removed volume) Resistenza all'abrasione profonda delle piastrelle non smaltate (volume materiale asportato)	ISO 10545-6	≤ 175 mm <sup>3</sup>	≤ 150 mm <sup>3</sup>	≤ 150 mm <sup>3</sup>	≤ 150 mm <sup>3</sup>	≤ 150 mm <sup>3</sup>	≤ 150 mm <sup>3</sup>	≤ 150 mm <sup>3</sup>		
Thermal and hygrometric characteristics	Coefficient of thermal linear expansion Coefficiente di dilatazione termica lineare	ISO 10545-8	Declared value Valore dichiarato	≤ 7 MK <sup>-1</sup>	≤ 7 MK <sup>-1</sup>	≤ 7 MK <sup>-1</sup>	≤ 7 MK <sup>-1</sup>	≤ 7 MK <sup>-1</sup>	≤ 7 MK <sup>-1</sup>		
	Thermal shock resistance Resistenza agli sbalzi termici	ISO 10545-9	Pass according to EN ISO 10545-1 Test superato in accordo con ISO 10545-1	Resistant Resiste	Resistant Resiste	Resistant Resiste	Resistant Resiste	Resistant Resiste	Resistant Resiste		
	Moisture expansion (in mm/m) Dilatazione all'umidità (in mm/m)	ISO 10545-10	Declared value Valore dichiarato	≤ 0,01% (0,1mm/m)	≤ 0,01% (0,1mm/m)	≤ 0,01% (0,1mm/m)	≤ 0,01% (0,1mm/m)	≤ 0,01% (0,1mm/m)	≤ 0,01% (0,1mm/m)		
	Frost resistance Resistenza al gelo	ISO 10545-12	Pass according to EN ISO 10545-1 Test superato in accordo con ISO 10545-1	Resistant Resiste	Resistant Resiste	Resistant Resiste	Resistant Resiste	Resistant Resiste	Resistant Resiste		
Physical properties	Bond strength/adhesion for improved cementitious adhesives Adesione a trazione con adesivi cementizi migliorati	EN 1348	Declared value Valore dichiarato	≥ 1,0 N/mm <sup>2</sup> (Class C2 - EN 12004)	≥ 1,0 N/mm <sup>2</sup> (Class C2 - EN 12004)	≥ 1,0 N/mm <sup>2</sup> (Class C2 - EN 12004)	≥ 1,0 N/mm <sup>2</sup> (Class C2 - EN 12004)	≥ 1,0 N/mm <sup>2</sup> (Class C2 - EN 12004)	≥ 1,0 N/mm <sup>2</sup> (Class C2 - EN 12004)		
	Reaction to fire Reazione al fuoco	-	Class A1 or A1 <sub>s</sub> Classe A1 oppure A1 <sub>s</sub>	A1 - A1 <sub>s</sub>	A1 - A1 <sub>s</sub>	A1 - A1 <sub>s</sub>	A1 - A1 <sub>s</sub>	A1 - A1 <sub>s</sub>	A1 - A1 <sub>s</sub>		
Chemical characteristics	Resistance to household chemicals and swimming pool salts Resistenza ai prodotti chimici di uso domestico ed agli additivi per piscina	ISO 10545-13	Minimum Class B Classe minima B	A	A	A	A	A	A		
	Resistance to low concentrations of acids and alkalis Resistenza a basse concentrazioni di acidi e alcali		Declared Class Classe dichiarata	LA	LA	LA	LA	LA	LA		
	Resistance to high concentrations of acids and alkalis Resistenza ad alte concentrazioni di acidi e alcali	Declared Class Classe dichiarata	HA	HA	HA	HA	HA	HA			
Safety characteristics (1)(2)	Resistance to staining, for unglazed tiles Resistenza alle macchie per piastrelle non smaltate	ISO 10545-14	Declared Class Classe dichiarata	5	5	5	5	5	5		
	Shod Ramp Test Metodo della rampa "calzato"	DIN EN 16165 ANNEX B (EX DIN 51130)	Declared value Valore dichiarato	R10	R11	R11	R10	R10	R11		
	Barefoot Ramp Test Metodo della rampa a piedi nudi	DIN EN 16165 ANNEX A (EX DIN 51097)	Declared value Valore dichiarato	B	C	C	B	B	C		
	Pendulum Friction Test Metodo del Pendolo	BS EN 16165 ANNEX C (EX BS 7976)	PTV ≥ 36 classifies the surface as "low slip risk"	≥ 36 Dry ≥ 36 Wet	≥ 36 Dry ≥ 36 Wet	≥ 36 Dry ≥ 36 Wet	≥ 36 Dry ≥ 36 Wet	≥ 36 Dry ≥ 36 Wet	≥ 36 Dry ≥ 36 Wet		
		AS 4586	Declared Classification of the new pedestrian surface materials according to the Pendulum Test	Class P3	Class P4	Class P4	Class P3	Class P3			
Coefficient of friction (COF) Coefficiente di attrito	B.C.R.A. Rep. CEC/81	D.M. 236/89 del 14/06/89 μ > 0,40 per elemento scivolante cuoio su pavimentazione asciutta μ > 0,40 per elemento scivolante gomma dura su pavimentazione bagnata	> 0,40 Asciutto > 0,40 Bagnato	> 0,40 Asciutto > 0,40 Bagnato	> 0,40 Asciutto > 0,40 Bagnato	> 0,40 Asciutto > 0,40 Bagnato	> 0,40 Asciutto > 0,40 Bagnato	> 0,40 Asciutto > 0,40 Bagnato			
	ANSI A 326,3	-	wet DCOF ≥ 0,50	wet DCOF ≥ 0,55	wet DCOF ≥ 0,55	wet DCOF ≥ 0,50	wet DCOF ≥ 0,50				

Technical feature - Caratteristiche tecniche - Caractéristiques techniques - Technische Daten - Características técnicas - Технические характеристики

BLAZE		BOOST				BOOST MIX				BOOST NATURAL			
		Matte Senstech ± 9 mm	Matte ± 6 mm	Grip ± 6 mm	Outdoor ± 20 mm	Matte Senstech ± 9 mm	Matte ± 6 mm	Grip ± 9 mm	Outdoor ± 20 mm	Matte Senstech ± 9 mm (1)	Matte ± 6 mm (1)	Grip ± 9 mm	Outdoor ± 20 mm
Suitable for Conforme	Suitable for Conforme	Suitable for Conforme	Suitable for Conforme	Suitable for Conforme	Suitable for Conforme	Suitable for Conforme	Suitable for Conforme	Suitable for Conforme	Suitable for Conforme	Suitable for Conforme	Suitable for Conforme	Suitable for Conforme	Suitable for Conforme
Suitable for Conforme	Suitable for Conforme	Suitable for Conforme	Suitable for Conforme	Suitable for Conforme	Suitable for Conforme	Suitable for Conforme	Suitable for Conforme	Suitable for Conforme	Suitable for Conforme	Suitable for Conforme	Suitable for Conforme	Suitable for Conforme	Suitable for Conforme
Suitable for Conforme	Suitable for Conforme	Suitable for Conforme	Suitable for Conforme	Suitable for Conforme	Suitable for Conforme	Suitable for Conforme	Suitable for Conforme	Suitable for Conforme	Suitable for Conforme	Suitable for Conforme	Suitable for Conforme	Suitable for Conforme	Suitable for Conforme
Suitable for Conforme	Suitable for Conforme	Suitable for Conforme	Suitable for Conforme	Suitable for Conforme	Suitable for Conforme	Suitable for Conforme	Suitable for Conforme	Suitable for Conforme	Suitable for Conforme	Suitable for Conforme	Suitable for Conforme	Suitable for Conforme	Suitable for Conforme
Suitable for Conforme	Suitable for Conforme	Suitable for Conforme	Suitable for Conforme	Suitable for Conforme	Suitable for Conforme	Suitable for Conforme	Suitable for Conforme	Suitable for Conforme	Suitable for Conforme	Suitable for Conforme	Suitable for Conforme	Suitable for Conforme	Suitable for Conforme
≤ 0,1%	≤ 0,1%	≤ 0,1%	≤ 0,1%	≤ 0,1%	≤ 0,1%	≤ 0,1%	≤ 0,1%	≤ 0,1%	≤ 0,1%	≤ 0,1%	≤ 0,1%	≤ 0,1%	≤ 0,1%
≤ 0,5%	≤ 0,5%	≤ 0,5%	≤ 0,5%	≤ 0,5%	≤ 0,5%	≤ 0,5%	≤ 0,5%	≤ 0,5%	≤ 0,5%	≤ 0,5%	≤ 0,5%	≤ 0,5%	≤ 0,5%
S ≥ 1000 N	S ≥ 10000 N	S ≥ 1500 N	S ≥ 1000 N	S ≥ 1500 N	S ≥ 10000 N	S ≥ 1500 N	S ≥ 1000 N	S ≥ 1500 N	S ≥ 10000 N	S ≥ 1500 N	S ≥ 1000 N	S ≥ 1500 N	S ≥ 10000 N
R ≥ 40 N/mm <sup>2</sup>	R ≥ 45 N/mm <sup>2</sup>	R ≥ 40 N/mm <sup>2</sup>	R ≥ 40 N/mm <sup>2</sup>	R ≥ 40 N/mm <sup>2</sup>	R ≥ 45 N/mm <sup>2</sup>	R ≥ 40 N/mm <sup>2</sup>	R ≥ 40 N/mm <sup>2</sup>	R ≥ 40 N/mm <sup>2</sup>	R ≥ 45 N/mm <sup>2</sup>	R ≥ 40 N/mm <sup>2</sup>	R ≥ 40 N/mm <sup>2</sup>	R ≥ 40 N/mm <sup>2</sup>	R ≥ 45 N/mm <sup>2</sup>
-	≥ T11 120x120 60x60	-	-	-	≥ T11 120x120 60x60	≥ U11 90x90	≥ U4 60x120	-	-	≥ T11 120x120 60x60	≥ U4 60x120	-	≥ T11 120x120 60x60
≥ 0,55	≥ 0,55	≥ 0,55	≥ 0,55	≥ 0,55	≥ 0,55	≥ 0,55	≥ 0,55	≥ 0,55	≥ 0,55	≥ 0,55	≥ 0,55	≥ 0,55	≥ 0,55
≤ 150 mm <sup>3</sup>	≤ 150 mm <sup>3</sup>	≤ 150 mm <sup>3</sup>	≤ 150 mm <sup>3</sup>	≤ 150 mm <sup>3</sup>	≤ 150 mm <sup>3</sup>	≤ 150 mm <sup>3</sup>	≤ 150 mm <sup>3</sup>	≤ 150 mm <sup>3</sup>	≤ 150 mm <sup>3</sup>	≤ 150 mm <sup>3</sup>	≤ 150 mm <sup>3</sup>	≤ 150 mm <sup>3</sup>	≤ 150 mm <sup>3</sup>
≤ 7 MK <sup>-1</sup>	≤ 7 MK <sup>-1</sup>	≤ 7 MK <sup>-1</sup>	≤ 7 MK <sup>-1</sup>	≤ 7 MK <sup>-1</sup>	≤ 7 MK <sup>-1</sup>	≤ 7 MK <sup>-1</sup>	≤ 7 MK <sup>-1</sup>	≤ 7 MK <sup>-1</sup>	≤ 7 MK <sup>-1</sup>	≤ 7 MK <sup>-1</sup>	≤ 7 MK <sup>-1</sup>	≤ 7 MK <sup>-1</sup>	≤ 7 MK <sup>-1</sup>
Resistant Resiste	Resistant Resiste	Resistant Resiste	Resistant Resiste	Resistant Resiste	Resistant Resiste	Resistant Resiste	Resistant Resiste	Resistant Resiste	Resistant Resiste	Resistant Resiste	Resistant Resiste	Resistant Resiste	Resistant Resiste
≤ 0,01% (0,1mm/m)	≤ 0,01% (0,1mm/m)	≤ 0,01% (0,1mm/m)	≤ 0,01% (0,1mm/m)	≤ 0,01% (0,1mm/m)	≤ 0,01% (0,1mm/m)	≤ 0,01% (0,1mm/m)	≤ 0,01% (0,1mm/m)	≤ 0,01% (0,1mm/m)	≤ 0,01% (0,1mm/m)	≤ 0,01% (0,1mm/m)	≤ 0,01% (0,1mm/m)	≤ 0,01% (0,1mm/m)	≤ 0,01% (0,1mm/m)
Resistant Resiste	Resistant Resiste	Resistant Resiste	Resistant Resiste	Resistant Resiste	Resistant Resiste	Resistant Resiste	Resistant Resiste	Resistant Resiste	Resistant Resiste	Resistant Resiste	Resistant Resiste	Resistant Resiste	Resistant Resiste
≥ 1,0 N/mm <sup>2</sup> (Class C2 - EN 12004)	≥ 1,0 N/mm <sup>2</sup> (Class C2 - EN 12004)	≥ 1,0 N/mm <sup>2</sup> (Class C2 - EN 12004)	≥ 1,0 N/mm <sup>2</sup> (Class C2 - EN 12004)	≥ 1,0 N/mm <sup>2</sup> (Class C2 - EN 12004)	≥ 1,0 N/mm <sup>2</sup> (Class C2 - EN 12004)	≥ 1,0 N/mm <sup>2</sup> (Class C2 - EN 12004)	≥ 1,0 N/mm <sup>2</sup> (Class C2 - EN 12004)	≥ 1,0 N/mm <sup>2</sup> (Class C2 - EN 12004)	≥ 1,0 N/mm <sup>2</sup> (Class C2 - EN 12004)	≥ 1,0 N/mm <sup>2</sup> (Class C2 - EN 12004)	≥ 1,0 N/mm <sup>2</sup> (Class C2 - EN 12004)	≥ 1,0 N/mm <sup>2</sup> (Class C2 - EN 12004)	≥ 1,0 N/mm <sup>2</sup> (Class C2 - EN 12004)
A1 - A1 <sub>s</sub>	A1 - A1 <sub>s</sub>	A1 - A1 <sub>s</sub>	A1 - A1 <sub>s</sub>	A1 - A1 <sub>s</sub>	A1 - A1 <sub>s</sub>	A1 - A1 <sub>s</sub>	A1 - A1 <sub>s</sub>	A1 - A1 <sub>s</sub>	A1 - A1 <sub>s</sub>	A1 - A1 <sub>s</sub>	A1 - A1 <sub>s</sub>	A1 - A1 <sub>s</sub>	A1 - A1 <sub>s</sub>
A	A	A	A	A	A	A	A	A	A	A	A	A	A
LA	LA	LA	LA	LA	LA	LA	LA	LA	LA	LA	LA	LA	LA
HA	HA	HA	HA	HA	HA	HA	HA	HA	HA	HA	HA	HA	HA
5	5	5	5	5	5	5	5	5	5	5	5	5	5
R9	R11	R10	R9	R11	R11	R10	R9	R11	R10	R9	R11	R10	R11
A	C	B	A	C	C	B	A	C	C	B	A	C	C
(●)	≥ 36 Dry ≥ 36 Wet	≥ 36 Dry ≥ 36 Wet	(●)	≥ 36 Dry ≥ 36 Wet	≥ 36 Dry ≥ 36 Wet	≥ 36 Dry ≥ 36 Wet	(●)	≥ 36 Dry ≥ 36 Wet	≥ 36 Dry ≥ 36 Wet	(●)	≥ 36 Dry ≥ 36 Wet	≥ 36 Dry ≥ 36 Wet	≥ 36 Dry ≥ 36 Wet
(●●)	Class P4	Class P3	(●●)	Class P4	Class P4	Class P3	(●●)	Class P4	Class P4	Class P3	(●●)	Class P4	Class P4
(●●●)	Class C3	Class C2	(●●●)	Class C3	Class C3	Class C2	(●●●)	Class C3	Class C3	Class C2	(●●●)	Class C3	Class C3
> 0,40 Asciutto > 0,40 Bagnato	> 0,40 Asciutto > 0,40 Bagnato	> 0,40 Asciutto > 0,40 Bagnato	> 0,40 Asciutto > 0,40 Bagnato	> 0,40 Asciutto > 0,40 Bagnato	> 0,40 Asciutto > 0,40 Bagnato	> 0,40 Asciutto > 0,40 Bagnato	> 0,40 Asciutto > 0,40 Bagnato	> 0,40 Asciutto > 0,40 Bagnato	> 0,40 Asciutto > 0,40 Bagnato	> 0,40 Asciutto > 0,40 Bagnato	> 0,40 Asciutto > 0,40 Bagnato	> 0,40 Asciutto > 0,40 Bagnato	> 0,40 Asciutto > 0,40 Bagnato
wet DCOF ≥ 0,42	wet DCOF ≥ 0,55	wet DCOF ≥ 0,50	wet DCOF ≥ 0,42	wet DCOF ≥ 0,55	wet DCOF ≥ 0,55	wet DCOF ≥ 0,50	wet DCOF ≥ 0,42	wet DCOF ≥ 0,55	wet DCOF ≥ 0,55	wet DCOF ≥ 0,50	wet DCOF ≥ 0,42	wet DCOF ≥ 0,55	wet DCOF ≥ 0,55

(●) PTV ≥ 36 Wet on demand - su richiesta (●●) P3 on demand - su richiesta (●●●) C2 on demand - su richiesta

A COMPLETE  
PRODUCT  
SYSTEM



PRODUCT  
FINDER



SURFACE  
RANGE



COMPANY



COLLECTIONS



LARGE SIZES



SLABS FOR  
COUNTERTOPS  
& FURNITURE



SINKS &  
BATHROOM  
FURNISHING



FACADES



<sup>(1)</sup> Boost Natural Cobalt <sup>(2)</sup> Glazed Porcelain Tiles <sup>(3)</sup> PEI 3 (ISO 10545-7) Boost Natural Cobalt

TECHNICAL  
SPECIFICATIONS







Porcelain tiles technical features

			Requirements for nominal size N Requisiti per dimensione nominale N			MARVEL				MARVEL DREAM	
			7 cm ≤ N < 15 cm (mm)	N ≥ 15 cm (%) (mm)		Matte Sensitech ± 9 mm	Matte ± 6 mm	Polished ± 9 mm	Polished ± 6 mm	Matte Sensitech ± 9 mm	
Regularity characteristics	Length and width Lunghezza e larghezza	ISO 10545-2	± 0,9 (*) Non-rect. ± 0,4 (*) Rect.	± 0,6 (*) Non-rect. ± 0,3 (*) Rect.	± 2,0 (*) Non-rect. ± 1,0 (*) Rect.	Suitable for Conforme	Suitable for Conforme	Suitable for Conforme	Suitable for Conforme	Suitable for Conforme	
	Thickness Spessore		± 0,5 (**)	± 5 (***)	± 0,5 (***)	Suitable for Conforme	Suitable for Conforme	Suitable for Conforme	Suitable for Conforme	Suitable for Conforme	
	Straightness of sides Rettilineità degli spigoli		± 0,8 (***) Non-rect. ± 0,4 (***) Rect.	± 0,5 (***) Non-rect. ± 0,3 (***) Rect.	± 1,5 (***) Non-rect. ± 0,8 (***) Rect.	Suitable for Conforme	Suitable for Conforme	Suitable for Conforme	Suitable for Conforme	Suitable for Conforme	
Structural characteristics	Water absorption (in % by mass) Massa d'acqua assorbita (come % della massa)	ISO 10545-3 ASTM C373-18	E <sub>s</sub> ≤ 0,5% Individual max 0,6% E <sub>s</sub> ≤ 0,5% Valore max singolo 0,6%			≤ 0,1 %	≤ 0,1 %	≤ 0,1 %	≤ 0,1 %	≤ 0,1 %	
			Requirement ANSI A137.1 Water Absorption Max ≤ 0,5%			≤ 0,5 %	≤ 0,5 %	≤ 0,5 %	≤ 0,5 %	≤ 0,5 %	
			S ≥ 700N (for thickness < 7,5 mm - per spessore < 7,5 mm) S ≥ 1300N (for thickness ≥ 7,5 mm - per spessore ≥ 7,5 mm)			S ≥ 1500 N	S ≥ 1000 N	S ≥ 1500 N	S ≥ 1000 N	S ≥ 1500 N	
Bulk mechanical characteristics	Modulus of rupture Resistenza alla flessione	ISO 10545-4	R ≥ 35 N/mm <sup>2</sup>			R ≥ 40 N/mm <sup>2</sup>	R ≥ 40 N/mm <sup>2</sup>	R ≥ 40 N/mm <sup>2</sup>	R ≥ 40 N/mm <sup>2</sup>	R ≥ 40 N/mm <sup>2</sup>	
	Bending strength and breaking load Resistenza a flessione e al carico di rottura (4)(5)		-	-	-	-					
	Impact resistance, as coefficient of restitution Resistenza all'impatto, espresso come coefficiente di restituzione		ISO 10545-5	Declared value Valore dichiarato			≥ 0,55	≥ 0,55	≥ 0,55	≥ 0,55	≥ 0,55
Surface mechanical characteristics	Resistance to deep abrasion of unglazed tiles (removed volume) Resistenza all'abrasione profonda delle piastrelle non smaltate (volume materiale asportato)	ISO 10545-6	≤ 175 mm <sup>3</sup>			≤ 150 mm <sup>3</sup>	≤ 150 mm <sup>3</sup>	≤ 150 mm <sup>3</sup>	≤ 150 mm <sup>3</sup>	≤ 150 mm <sup>3</sup>	
	Coefficient of thermal linear expansion Coefficiente di dilatazione termica lineare	ISO 10545-8	Declared value Valore dichiarato			≤ 7 MK <sup>-1</sup>	≤ 7 MK <sup>-1</sup>	≤ 7 MK <sup>-1</sup>	≤ 7 MK <sup>-1</sup>	≤ 7 MK <sup>-1</sup>	
Thermal and hygrometric characteristics	Thermal shock resistance Resistenza agli sbalzi termici	ISO 10545-9	Pass according to EN ISO 10545-1 Test superato in accordo con ISO 10545-1			Resistant Resiste	Resistant Resiste	Resistant Resiste	Resistant Resiste	Resistant Resiste	
	Moisture expansion (in mm/m) Dilatazione all'umidità (in mm/m)	ISO 10545-10	Declared value Valore dichiarato			≤ 0,01% (0,1mm/m)	≤ 0,01% (0,1mm/m)	≤ 0,01% (0,1mm/m)	≤ 0,01% (0,1mm/m)	≤ 0,01% (0,1mm/m)	
	Frost resistance Resistenza al gelo	ISO 10545-12	Pass according to EN ISO 10545-1 Test superato in accordo con ISO 10545-1			Resistant Resiste	Resistant Resiste	Resistant Resiste	Resistant Resiste	Resistant Resiste	
Physical properties	Bond strength/adhesion for improved cementitious adhesives Adesione a trazione con adesivi cementizi migliorati	EN 1348	Declared value Valore dichiarato			≥ 10 N/mm <sup>2</sup> (Class C2 - EN 12004)	≥ 10 N/mm <sup>2</sup> (Class C2 - EN 12004)	≥ 10 N/mm <sup>2</sup> (Class C2 - EN 12004)	≥ 10 N/mm <sup>2</sup> (Class C2 - EN 12004)	≥ 10 N/mm <sup>2</sup> (Class C2 - EN 12004)	
	Reaction to fire Reazione al fuoco	-	Class A1 or A1 <sub>s</sub> Classe A1 oppure A1 <sub>s</sub>			A1 - A1 <sub>s</sub>	A1 - A1 <sub>s</sub>	A1 - A1 <sub>s</sub>	A1 - A1 <sub>s</sub>	A1 - A1 <sub>s</sub>	
Chemical characteristics	Resistance to household chemicals and swimming pool salts Resistenza ai prodotti chimici di uso domestico ed agli additivi per piscina	ISO 10545-13	Minimum Class B Classe minima B			A	A	A	A	A	
	Resistance to low concentrations of acids and alkalis Resistenza a basse concentrazioni di acidi e alcali		Declared Class Classe dichiarata			LA	LA	LA	LA	LA	
	Resistance to high concentrations of acids and alkalis Resistenza ad alte concentrazioni di acidi e alcali		Declared Class Classe dichiarata			HA	HA	-	-	HA	
	Resistance to staining, for unglazed tiles Resistenza alle macchie per piastrelle non smaltate	ISO 10545-14	Declared Class Classe dichiarata			5	5	5	5	5	
Safety characteristics (1)(2)	Shod Ramp Test Metodo della rampa "calzato"	DIN EN 16165 ANNEX B (EX DIN 51130)	Declared value Valore dichiarato			R10	R9	N.C.	N.C.	R10	
	Barefoot Ramp Test Metodo della rampa a piedi nudi	DIN EN 16165 ANNEX A (EX DIN 51097)	Declared value Valore dichiarato			B	A	0	0	B	
	Pendulum Friction Test Metodo del Pendolo	BS EN 16165 ANNEX C (EX BS 7976)	PTV ≥ 36 classifies the surface as "low slip risk"			≥ 36 Dry ≥ 36 Wet	(●)	≥ 36 Dry ≤ 24 Wet	≥ 36 Dry ≤ 24 Wet	≥ 36 Dry ≥ 36 Wet	
		AS 4586	Declared Classification of the new pedestrian surface materials according to the Pendulum Test			Class P3	(●●)	-	-	Class P3	
	Coefficient of friction (COF) Coefficiente di attrito	B.C.R.A. Rep. CEC/81	D. M. 236/89 del 14/06/89 μ>0,40 per elemento scivolante cuoio su pavimentazione asciutta μ>0,40 per elemento scivolante gomma dura su pavimentazione bagnata	Declared value Valore dichiarato			Class C2	(●●●)	-	-	Class C2
				> 0,40 Asciutto > 0,40 Bagnato	> 0,40 Asciutto > 0,40 Bagnato	> 0,40 Asciutto < 0,40 Bagnato	> 0,40 Asciutto < 0,40 Bagnato	> 0,40 Asciutto > 0,40 Bagnato			
Dynamic coefficient of friction (DCOF) Coefficiente di attrito dinamico	ANSI A 326.3	-			wet DCOF ≥ 0,50	wet DCOF ≥ 0,42	dry DCOF ≥ 0,42	dry DCOF ≥ 0,42	wet DCOF ≥ 0,50		

Technical feature - Caratteristiche tecniche - Caractéristiques techniques - Technische Daten - Características técnicas - Технические характеристики

MARVEL DREAM			MARVEL EDGE			MARVEL GALA		MARVEL GEMS	MARVEL PRO					
Matte ± 6 mm	Polished ± 9 mm	Polished ± 6 mm (1)	Matte Sensitech ± 9 mm	Polished ± 6 mm	Polished ± 9 mm	Polished ± 9 mm	Polished ± 6 mm	Matte Sensitech ± 9 mm	Matte Sensitech ± 9 mm	Matte ± 6 mm	Polished ± 9 mm	Polished ± 6 mm	Textured ± 9 mm	
Suitable for Conforme	Suitable for Conforme	Suitable for Conforme	Suitable for Conforme	Suitable for Conforme	Suitable for Conforme	Suitable for Conforme	Suitable for Conforme	Suitable for Conforme	Suitable for Conforme	Suitable for Conforme	Suitable for Conforme	Suitable for Conforme	Suitable for Conforme	
Suitable for Conforme	Suitable for Conforme	Suitable for Conforme	Suitable for Conforme	Suitable for Conforme	Suitable for Conforme	Suitable for Conforme	Suitable for Conforme	Suitable for Conforme	Suitable for Conforme	Suitable for Conforme	Suitable for Conforme	Suitable for Conforme	Suitable for Conforme	
Suitable for Conforme	Suitable for Conforme	Suitable for Conforme	Suitable for Conforme	Suitable for Conforme	Suitable for Conforme	Suitable for Conforme	Suitable for Conforme	Suitable for Conforme	Suitable for Conforme	Suitable for Conforme	Suitable for Conforme	Suitable for Conforme	Suitable for Conforme	
Suitable for Conforme	Suitable for Conforme	Suitable for Conforme	Suitable for Conforme	Suitable for Conforme	Suitable for Conforme	Suitable for Conforme	Suitable for Conforme	Suitable for Conforme	Suitable for Conforme	Suitable for Conforme	Suitable for Conforme	Suitable for Conforme	Suitable for Conforme	
≤ 0,1 %	≤ 0,1 %	≤ 0,1 %	≤ 0,1 %	≤ 0,1 %	≤ 0,1 %	≤ 0,1 %	≤ 0,1 %	≤ 0,1 %	≤ 0,1 %	≤ 0,1 %	≤ 0,1 %	≤ 0,1 %	≤ 0,1 %	
≤ 0,5 %	≤ 0,5 %	≤ 0,5 %	≤ 0,5 %	≤ 0,5 %	≤ 0,5 %	≤ 0,5 %	≤ 0,5 %	≤ 0,5 %	≤ 0,5 %	≤ 0,5 %	≤ 0,5 %	≤ 0,5 %	≤ 0,5 %	
S ≥ 1000 N	S ≥ 1500 N	S ≥ 1000 N	S ≥ 1500 N	S ≥ 1000 N	S ≥ 1500 N	S ≥ 1500 N	S ≥ 1500 N	S ≥ 1500 N	S ≥ 1500 N	S ≥ 1000 N	S ≥ 1500 N	S ≥ 1000 N	S ≥ 1500 N	
R ≥ 40 N/mm <sup>2</sup>	R ≥ 40 N/mm <sup>2</sup>	R ≥ 40 N/mm <sup>2</sup>	R ≥ 40 N/mm <sup>2</sup>	R ≥ 40 N/mm <sup>2</sup>	R ≥ 40 N/mm <sup>2</sup>	R ≥ 40 N/mm <sup>2</sup>	R ≥ 40 N/mm <sup>2</sup>	R ≥ 40 N/mm <sup>2</sup>	R ≥ 40 N/mm <sup>2</sup>	R ≥ 40 N/mm <sup>2</sup>	R ≥ 40 N/mm <sup>2</sup>	R ≥ 40 N/mm <sup>2</sup>	R ≥ 40 N/mm <sup>2</sup>	
-	-	-	-	-	-	-	-	-	-	-	-	-	-	
≥ 0,55	≥ 0,55	≥ 0,55	≥ 0,55	≥ 0,55	≥ 0,55	≥ 0,55	≥ 0,55	≥ 0,55	≥ 0,55	≥ 0,55	≥ 0,55	≥ 0,55	≥ 0,55	
≤ 150 mm <sup>3</sup>	≤ 150 mm <sup>3</sup>	≤ 150 mm <sup>3</sup> (2)	≤ 150 mm <sup>3</sup>	≤ 150 mm <sup>3</sup>	≤ 150 mm <sup>3</sup>	≤ 150 mm <sup>3</sup>	≤ 150 mm <sup>3</sup>	≤ 150 mm <sup>3</sup>	≤ 150 mm <sup>3</sup>	≤ 150 mm <sup>3</sup>	≤ 150 mm <sup>3</sup>	≤ 150 mm <sup>3</sup>	≤ 150 mm <sup>3</sup>	
≤ 7 MK <sup>-1</sup>	≤ 7 MK <sup>-1</sup>	≤ 7 MK <sup>-1</sup>	≤ 7 MK <sup>-1</sup>	≤ 7 MK <sup>-1</sup>	≤ 7 MK <sup>-1</sup>	≤ 7 MK <sup>-1</sup>	≤ 7 MK <sup>-1</sup>	≤ 7 MK <sup>-1</sup>	≤ 7 MK <sup>-1</sup>	≤ 7 MK <sup>-1</sup>	≤ 7 MK <sup>-1</sup>	≤ 7 MK <sup>-1</sup>	≤ 7 MK <sup>-1</sup>	
Resistant Resiste	Resistant Resiste	Resistant Resiste	Resistant Resiste	Resistant Resiste	Resistant Resiste	Resistant Resiste	Resistant Resiste	Resistant Resiste	Resistant Resiste	Resistant Resiste	Resistant Resiste	Resistant Resiste	Resistant Resiste	
≤ 0,01% (0,1mm/m)	≤ 0,01% (0,1mm/m)	≤ 0,01% (0,1mm/m)	≤ 0,01% (0,1mm/m)	≤ 0,01% (0,1mm/m)	≤ 0,01% (0,1mm/m)	≤ 0,01% (0,1mm/m)	≤ 0,01% (0,1mm/m)	≤ 0,01% (0,1mm/m)	≤ 0,01% (0,1mm/m)	≤ 0,01% (0,1mm/m)	≤ 0,01% (0,1mm/m)	≤ 0,01% (0,1mm/m)	≤ 0,01% (0,1mm/m)	
Resistant Resiste	Resistant Resiste	Resistant Resiste	Resistant Resiste	Resistant Resiste	Resistant Resiste	Resistant Resiste	Resistant Resiste	Resistant Resiste	Resistant Resiste	Resistant Resiste	Resistant Resiste	Resistant Resiste	Resistant Resiste	
≥ 10 N/mm <sup>2</sup> (Class C2 - EN 12004)	≥ 10 N/mm <sup>2</sup> (Class C2 - EN 12004)	≥ 10 N/mm <sup>2</sup> (Class C2 - EN 12004)	≥ 10 N/mm <sup>2</sup> (Class C2 - EN 12004)	≥ 10 N/mm <sup>2</sup> (Class C2 - EN 12004)	≥ 10 N/mm <sup>2</sup> (Class C2 - EN 12004)	≥ 10 N/mm <sup>2</sup> (Class C2 - EN 12004)	≥ 10 N/mm <sup>2</sup> (Class C2 - EN 12004)	≥ 10 N/mm <sup>2</sup> (Class C2 - EN 12004)	≥ 10 N/mm <sup>2</sup> (Class C2 - EN 12004)	≥ 10 N/mm <sup>2</sup> (Class C2 - EN 12004)	≥ 10 N/mm <sup>2</sup> (Class C2 - EN 12004)	≥ 10 N/mm <sup>2</sup> (Class C2 - EN 12004)	≥ 10 N/mm <sup>2</sup> (Class C2 - EN 12004)	
A1 - A1 <sub>s</sub>	A1 - A1 <sub>s</sub>	A1 - A1 <sub>s</sub>	A1 - A1 <sub>s</sub>	A1 - A1 <sub>s</sub>	A1 - A1 <sub>s</sub>	A1 - A1 <sub>s</sub>	A1 - A1 <sub>s</sub>	A1 - A1 <sub>s</sub>	A1 - A1 <sub>s</sub>	A1 - A1 <sub>s</sub>	A1 - A1 <sub>s</sub>	A1 - A1 <sub>s</sub>	A1 - A1 <sub>s</sub>	
A	A	A	A	A	A	A	A	A	A	A	A	A	A	
LA	LA	LA	LA	LA	LA	LA	LA	LA	LA	LA	LA	LA	LA	
HA	-	-	HA	-	-	-	-	HA	HA	HA	-	-	HA	
5	5	5	5	5	5	5	5	5	5	5	5	5	5	
R9	N.C.	N.C.	R10	N.C.	N.C.	N.C.	N.C.	R10	R10	R9	N.C.	N.C.	R11	
A	0	0	B	0	0	0	0	B	B	A	0	0	B	
(●)	≥ 36 Dry ≤ 24 Wet	≥ 36 Dry ≤ 24 Wet	≥ 36 Dry ≥ 36 Wet	≥ 36 Dry ≤ 24 Wet	≥ 36 Dry ≤ 24 Wet	≥ 36 Dry ≤ 24 Wet	≥ 36 Dry ≤ 24 Wet	≥ 36 Dry ≥ 36 Wet	≥ 36 Dry ≥ 36 Wet	(●)	≥ 36 Dry ≤ 24 Wet	≥ 36 Dry ≤ 24 Wet	≥ 36 Dry ≥ 36 Wet	
(●●)	-	-	Class P3	-	-	-	-	Class P3	Class P4	(●●)	-	-	Class P4	
(●●●)	-	-	Class C2	-	-	-	-	(●●●)	Class C3	(●●●)	-	-	Class C3	
> 0,40 Asciutto > 0,40 Bagnato	> 0,40 Asciutto < 0,40 Bagnato	> 0,40 Asciutto < 0,40 Bagnato	> 0,40 Asciutto > 0,40 Bagnato	> 0,40 Asciutto < 0,40 Bagnato	> 0,40 Asciutto < 0,40 Bagnato	> 0,40 Asciutto < 0,40 Bagnato	> 0,40 Asciutto < 0,40 Bagnato	> 0,40 Asciutto > 0,40 Bagnato	> 0,40 Asciutto > 0,40 Bagnato	> 0,40 Asciutto > 0,40 Bagnato	> 0,40 Asciutto < 0,40 Bagnato	> 0,40 Asciutto < 0,40 Bagnato	> 0,40 Asciutto > 0,40 Bagnato	
wet DCOF ≥ 0,42	dry DCOF ≥ 0,42	dry DCOF ≥ 0,42	wet DCOF ≥ 0,50	dry DCOF ≥ 0,42	dry DCOF ≥ 0,42	dry DCOF ≥ 0,42	dry DCOF ≥ 0,42	wet DCOF ≥ 0,50	wet DCOF ≥ 0,50	wet DCOF ≥ 0,42	dry DCOF ≥ 0,42	dry DCOF ≥ 0,42	wet DCOF ≥ 0,50	

(1) Marvel Dream Ultramarine "Glazed Porcelain Tiles"  
(2) PEI 3 (ISO 10545-7) Marvel Dream Ultramarine  
(●) PTV ≥ 36 Wet on demand - su richiesta (●●) P3 on demand - su richiesta (●●●) C2 on demand - su richiesta

### Porcelain tiles technical features

		Requirements for nominal size N Requisiti per dimensione nominale N			MARVEL SHINE				
		7 cm ≤ N < 15 cm (mm)	N ≥ 15 cm (%) (mm)		Matte Sensitech ± 9 mm	Silk ± 6 mm	Polished ± 9 mm	Polished ± 6 mm	Silk ± 9 mm
Regularity characteristics	Length and width Lunghezza e larghezza	± 0.9 (*) Non-rect. ± 0.4 (*) Rect.	± 0.6 (*) Non-rect. ± 0.3 (*) Rect.	± 2.0 (*) Non-rect. ± 1.0 (*) Rect.	Suitable for Conforme	Suitable for Conforme	Suitable for Conforme	Suitable for Conforme	Suitable for Conforme
	Thickness Spessore	± 0.5 (**)	± 5 (**)	± 0.5 (**)	Suitable for Conforme	Suitable for Conforme	Suitable for Conforme	Suitable for Conforme	Suitable for Conforme
	Straightness of sides Rettilineità degli spigoli	± 0.8 (***) Non-rect. ± 0.4 (***) Rect.	± 0.5 (***) Non-rect. ± 0.3 (***) Rect.	± 1.5 (***) Non-rect. ± 0.8 (***) Rect.	Suitable for Conforme	Suitable for Conforme	Suitable for Conforme	Suitable for Conforme	Suitable for Conforme
	Rectangularity (Measurement only on short edges when L/l ≥ 3) Ortogonalità (Misurazione da condurre solo sui lati corti quando L/l ≥ 3)	± 0.8 (***) Non-rect. ± 0.4 (***) Rect.	± 0.5 (***) Non-rect. ± 0.3 (***) Rect.	± 2.0 (***) Non-rect. ± 1.5 (***) Rect.	Suitable for Conforme	Suitable for Conforme	Suitable for Conforme	Suitable for Conforme	Suitable for Conforme
Structural characteristics	Water absorption (in % by mass) Massa d'acqua assorbita (come % della massa)	ISO 10545-3	E <sub>1</sub> ≤ 0.5% Individual max 0.6% E <sub>2</sub> ≤ 0.5% Valore max singolo 0.6%	≤ 0.1 %	≤ 0.1 %	≤ 0.1 %	≤ 0.1 %	≤ 0.1 %	
		ASTM C373-18	Requirement ANSI A137.1 Water Absorption Max ≤ 0.5%	≤ 0.5 %	≤ 0.5 %	≤ 0.5 %	≤ 0.5 %	≤ 0.5 %	
	Breaking strength Sforzo di rottura	ISO 10545-4	S ≥ 700N (for thickness < 7.5 mm - per spessore < 7.5 mm) S ≥ 1300N (for thickness ≥ 7.5 mm - per spessore ≥ 7.5 mm)	S ≥ 1500 N	S ≥ 1000 N	S ≥ 1500 N	S ≥ 1000 N	S ≥ 1500 N	
		Modulus of rupture Resistenza alla flessione	R ≥ 35 N/mm <sup>2</sup>	R ≥ 40 N/mm <sup>2</sup>	R ≥ 40 N/mm <sup>2</sup>	R ≥ 40 N/mm <sup>2</sup>	R ≥ 40 N/mm <sup>2</sup>	R ≥ 40 N/mm <sup>2</sup>	
Bulk mechanical characteristics	Bending strength and breaking load Resistenza a flessione e al carico di rottura (4)(5)	EN 1339 Annex F	-	-	-	-	-		
	Impact resistance, as coefficient of restitution Resistenza all'impatto, espresso come coefficiente di restituzione	ISO 10545-5	Declared value Valore dichiarato	≥ 0.55	≥ 0.55	≥ 0.55	≥ 0.55	≥ 0.55	
Surface mechanical characteristics	Resistance to deep abrasion of unglazed tiles (removed volume) Resistenza all'abrasione profonda delle piastrelle non smaltate (volume materiale asportato)	ISO 10545-6	≤ 175 mm <sup>3</sup>	≤ 150 mm <sup>3</sup>	≤ 150 mm <sup>3</sup>	≤ 150 mm <sup>3</sup>	≤ 150 mm <sup>3</sup>	≤ 150 mm <sup>3</sup>	
	Coefficient of thermal linear expansion Coefficiente di dilatazione termica lineare	ISO 10545-8	Declared value Valore dichiarato	≤ 7 MK <sup>-1</sup>	≤ 7 MK <sup>-1</sup>	≤ 7 MK <sup>-1</sup>	≤ 7 MK <sup>-1</sup>	≤ 7 MK <sup>-1</sup>	
Thermal and hygrometric characteristics	Thermal shock resistance Resistenza agli sbalzi termici	ISO 10545-9	Pass according to EN ISO 10545-1 Test superato in accordo con ISO 10545-1	Resistant Resiste	Resistant Resiste	Resistant Resiste	Resistant Resiste	Resistant Resiste	
	Moisture expansion (in mm/m) Dilatazione all'umidità (in mm/m)	ISO 10545-10	Declared value Valore dichiarato	≤ 0.01% (0,1mm/m)	≤ 0.01% (0,1mm/m)	≤ 0.01% (0,1mm/m)	≤ 0.01% (0,1mm/m)	≤ 0.01% (0,1mm/m)	
	Frost resistance Resistenza al gelo	ISO 10545-12	Pass according to EN ISO 10545-1 Test superato in accordo con ISO 10545-1	Resistant Resiste	Resistant Resiste	Resistant Resiste	Resistant Resiste	Resistant Resiste	
	Bond strength/adhesion for improved cementitious adhesives Adesione a trazione con adesivi cementizi migliorati	EN 1348	Declared value Valore dichiarato	≥ 10 N/mm <sup>2</sup> (Class C2 - EN 12004)	≥ 10 N/mm <sup>2</sup> (Class C2 - EN 12004)	≥ 10 N/mm <sup>2</sup> (Class C2 - EN 12004)	≥ 10 N/mm <sup>2</sup> (Class C2 - EN 12004)	≥ 10 N/mm <sup>2</sup> (Class C2 - EN 12004)	
Chemical characteristics	Reaction to fire Reazione al fuoco	-	Class A1 or A1 <sub>fl</sub> Classe A1 oppure A1 <sub>fl</sub>	A1 - A1 <sub>fl</sub>	A1 - A1 <sub>fl</sub>	A1 - A1 <sub>fl</sub>	A1 - A1 <sub>fl</sub>	A1 - A1 <sub>fl</sub>	
	Resistance to household chemicals and swimming pool salts Resistenza ai prodotti chimici di uso domestico ed agli additivi per piscina	ISO 10545-13	Minimum Class B Classe minima B	A	A	A	A	A	
	Resistance to low concentrations of acids and alkalis Resistenza a basse concentrazioni di acidi e alcali		Declared Class Classe dichiarata	LA	LA	LA	LA	LA	
	Resistance to high concentrations of acids and alkalis Resistenza ad alte concentrazioni di acidi e alcali		Declared Class Classe dichiarata	HA	HA	-	-	HA	
Resistance to staining, for unglazed tiles Resistenza alle macchie per piastrelle non smaltate	ISO 10545-14	Declared Class Classe dichiarata	5	5	5	5	5		
Safety characteristics (1)(2)	Shod Ramp Test Metodo della rampa "calzata"	DIN EN 16165 ANNEX B (EX DIN 51130)	Declared value Valore dichiarato	R10	N.C.	N.C.	N.C.	N.C.	
	Barefoot Ramp Test Metodo della rampa a piedi nudi	DIN EN 16165 ANNEX A (EX DIN 51097)	Declared value Valore dichiarato	B	0	0	0	0	
	Pendulum Friction Test Metodo del Pendolo	BS EN 16165 ANNEX C (EX BS 7976)	PTV ≥ 36 classifies the surface as 'low slip risk'	≥ 36 Dry ≥ 36 Wet	≥ 36 Dry ≤ 24 Wet	≥ 36 Dry ≤ 24 Wet	≥ 36 Dry ≤ 24 Wet	≥ 36 Dry ≤ 24 Wet	
		AS 4586	Declared Classification of the new pedestrian surface materials according to the Pendulum Test	Class P3	-	-	-	-	
	Coefficient of friction (COF) Coefficiente di attrito	B.C.R.A. Rep. CEC/81	D.M. 236/89 del 14/06/89 μ>0.40 per elemento scivolante cuoio su pavimentazione asciutta μ>0.40 per elemento scivolante gomma dura su pavimentazione bagnata	Declared value Valore dichiarato	Class C2	-	-	-	-
				Declared value Valore dichiarato	Class C2	-	-	-	-
	Dynamic coefficient of friction (DCOF) Coefficiente di attrito dinamico	ANSI A 326.3	-	wet DCOF ≥ 0.50	dry DCOF ≥ 0.42	dry DCOF ≥ 0.42	dry DCOF ≥ 0.42	dry DCOF ≥ 0.42	

Technical feature - Caratteristiche tecniche - Caractéristiques techniques - Technische Daten - Características técnicas - Технические характеристики

MARVEL STONE				MARVEL TRAVERTINE				MARVEL X					
Matte Sensitech ± 9 mm	Matte ± 6 mm	Polished ± 9 mm	Polished ± 6 mm	Matte Sensitech ± 9 mm	Matte ± 6 mm	Grip ± 9 mm	Outdoor ± 20 mm	Matte Sensitech ± 9 mm	Silk ± 6 mm	Silk ± 9 mm	Polished ± 9 mm	Polished ± 6 mm	Outdoor ± 20 mm
Suitable for Conforme	Suitable for Conforme	Suitable for Conforme	Suitable for Conforme	Suitable for Conforme	Suitable for Conforme	Suitable for Conforme	Suitable for Conforme	Suitable for Conforme	Suitable for Conforme	Suitable for Conforme	Suitable for Conforme	Suitable for Conforme	Suitable for Conforme
Suitable for Conforme	Suitable for Conforme	Suitable for Conforme	Suitable for Conforme	Suitable for Conforme	Suitable for Conforme	Suitable for Conforme	Suitable for Conforme	Suitable for Conforme	Suitable for Conforme	Suitable for Conforme	Suitable for Conforme	Suitable for Conforme	Suitable for Conforme
Suitable for Conforme	Suitable for Conforme	Suitable for Conforme	Suitable for Conforme	Suitable for Conforme	Suitable for Conforme	Suitable for Conforme	Suitable for Conforme	Suitable for Conforme	Suitable for Conforme	Suitable for Conforme	Suitable for Conforme	Suitable for Conforme	Suitable for Conforme
Suitable for Conforme	Suitable for Conforme	Suitable for Conforme	Suitable for Conforme	Suitable for Conforme	Suitable for Conforme	Suitable for Conforme	Suitable for Conforme	Suitable for Conforme	Suitable for Conforme	Suitable for Conforme	Suitable for Conforme	Suitable for Conforme	Suitable for Conforme
≤ 0.1 %	≤ 0.1 %	≤ 0.1 %	≤ 0.1 %	≤ 0.1 %	≤ 0.1 %	≤ 0.1 %	≤ 0.1 %	≤ 0.1 %	≤ 0.1 %	≤ 0.1 %	≤ 0.1 %	≤ 0.1 %	≤ 0.1 %
≤ 0.5 %	≤ 0.5 %	≤ 0.5 %	≤ 0.5 %	≤ 0.5 %	≤ 0.5 %	≤ 0.5 %	≤ 0.5 %	≤ 0.5 %	≤ 0.5 %	≤ 0.5 %	≤ 0.5 %	≤ 0.5 %	≤ 0.5 %
S ≥ 1500 N	S ≥ 1000 N	S ≥ 1500 N	S ≥ 1000 N	S ≥ 1500 N	S ≥ 1000 N	S ≥ 1500 N	S ≥ 10000 N	S ≥ 1500 N	S ≥ 1000 N	S ≥ 1500 N	S ≥ 1500 N	S ≥ 1000 N	S ≥ 10000 N
R ≥ 40 N/mm <sup>2</sup>	R ≥ 40 N/mm <sup>2</sup>	R ≥ 40 N/mm <sup>2</sup>	R ≥ 40 N/mm <sup>2</sup>	R ≥ 40 N/mm <sup>2</sup>	R ≥ 40 N/mm <sup>2</sup>	R ≥ 40 N/mm <sup>2</sup>	R ≥ 45 N/mm <sup>2</sup>	R ≥ 40 N/mm <sup>2</sup>	R ≥ 40 N/mm <sup>2</sup>	R ≥ 40 N/mm <sup>2</sup>	R ≥ 40 N/mm <sup>2</sup>	R ≥ 40 N/mm <sup>2</sup>	R ≥ 45 N/mm <sup>2</sup>
-	-	-	-	-	-	-	≥ U4 60x120	-	-	-	-	-	≥ T11 120x120 60x60
≥ 0.55	≥ 0.55	≥ 0.55	≥ 0.55	≥ 0.55	≥ 0.55	≥ 0.55	≥ 0.55	≥ 0.55	≥ 0.55	≥ 0.55	≥ 0.55	≥ 0.55	≥ 0.55
≤ 150 mm <sup>3</sup>	≤ 150 mm <sup>3</sup>	≤ 150 mm <sup>3</sup>	≤ 150 mm <sup>3</sup>	≤ 150 mm <sup>3</sup>	≤ 150 mm <sup>3</sup>	≤ 150 mm <sup>3</sup>	≤ 150 mm <sup>3</sup>	≤ 150 mm <sup>3</sup>	≤ 150 mm <sup>3</sup>	≤ 150 mm <sup>3</sup>	≤ 150 mm <sup>3</sup>	≤ 150 mm <sup>3</sup>	≤ 150 mm <sup>3</sup>
≤ 7 MK <sup>-1</sup>	≤ 7 MK <sup>-1</sup>	≤ 7 MK <sup>-1</sup>	≤ 7 MK <sup>-1</sup>	≤ 7 MK <sup>-1</sup>	≤ 7 MK <sup>-1</sup>	≤ 7 MK <sup>-1</sup>	≤ 7 MK <sup>-1</sup>	≤ 7 MK <sup>-1</sup>	≤ 7 MK <sup>-1</sup>	≤ 7 MK <sup>-1</sup>	≤ 7 MK <sup>-1</sup>	≤ 7 MK <sup>-1</sup>	≤ 7 MK <sup>-1</sup>
Resistant Resiste	Resistant Resiste	Resistant Resiste	Resistant Resiste	Resistant Resiste	Resistant Resiste	Resistant Resiste	Resistant Resiste	Resistant Resiste	Resistant Resiste	Resistant Resiste	Resistant Resiste	Resistant Resiste	Resistant Resiste
≤ 0.01% (0,1mm/m)	≤ 0.01% (0,1mm/m)	≤ 0.01% (0,1mm/m)	≤ 0.01% (0,1mm/m)	≤ 0.01% (0,1mm/m)	≤ 0.01% (0,1mm/m)	≤ 0.01% (0,1mm/m)	≤ 0.01% (0,1mm/m)	≤ 0.01% (0,1mm/m)	≤ 0.01% (0,1mm/m)	≤ 0.01% (0,1mm/m)	≤ 0.01% (0,1mm/m)	≤ 0.01% (0,1mm/m)	≤ 0.01% (0,1mm/m)
Resistant Resiste	Resistant Resiste	Resistant Resiste	Resistant Resiste	Resistant Resiste	Resistant Resiste	Resistant Resiste	Resistant Resiste	Resistant Resiste	Resistant Resiste	Resistant Resiste	Resistant Resiste	Resistant Resiste	Resistant Resiste
≥ 10 N/mm <sup>2</sup> (Class C2 - EN 12004)	≥ 10 N/mm <sup>2</sup> (Class C2 - EN 12004)	≥ 10 N/mm <sup>2</sup> (Class C2 - EN 12004)	≥ 10 N/mm <sup>2</sup> (Class C2 - EN 12004)	≥ 10 N/mm <sup>2</sup> (Class C2 - EN 12004)	≥ 10 N/mm <sup>2</sup> (Class C2 - EN 12004)	≥ 10 N/mm <sup>2</sup> (Class C2 - EN 12004)	≥ 10 N/mm <sup>2</sup> (Class C2 - EN 12004)	≥ 10 N/mm <sup>2</sup> (Class C2 - EN 12004)	≥ 10 N/mm <sup>2</sup> (Class C2 - EN 12004)	≥ 10 N/mm <sup>2</sup> (Class C2 - EN 12004)	≥ 10 N/mm <sup>2</sup> (Class C2 - EN 12004)	≥ 10 N/mm <sup>2</sup> (Class C2 - EN 12004)	≥ 10 N/mm <sup>2</sup> (Class C2 - EN 12004)
A1 - A1 <sub>fl</sub>	A1 - A1 <sub>fl</sub>	A1 - A1 <sub>fl</sub>	A1 - A1 <sub>fl</sub>	A1 - A1 <sub>fl</sub>	A1 - A1 <sub>fl</sub>	A1 - A1 <sub>fl</sub>	A1 - A1 <sub>fl</sub>	A1 - A1 <sub>fl</sub>	A1 - A1 <sub>fl</sub>	A1 - A1 <sub>fl</sub>	A1 - A1 <sub>fl</sub>	A1 - A1 <sub>fl</sub>	A1 - A1 <sub>fl</sub>
A	A	A	A	A	A	A	A	A	A	A	A	A	A
LA	LA	LA	LA	LA	LA	LA	LA	LA	LA	LA	LA	LA	LA
HA	HA	-	-	HA	HA	HA	HA	HA	HA	HA	-	-	HA
5	5	5	5	5	5	5	5	5	5	5	5	5	5
R10	R9	N.C.	N.C.	R10	R9	R11	R11	R10	N.C.	N.C.	N.C.	N.C.	R11
B	A	0	0	B	A	C	C	B	0	0	0	0	C
≥ 36 Dry ≥ 36 Wet	(●)	≥ 36 Dry ≤ 24 Wet	≥ 36 Dry ≤ 24 Wet	≥ 36 Dry ≥ 36 Wet	(●●)	≥ 36 Dry ≥ 36 Wet	≥ 36 Dry ≥ 36 Wet	≥ 36 Dry ≥ 36 Wet	≥ 36 Dry ≤ 24 Wet	≥ 36 Dry ≤ 24 Wet	≥ 36 Dry ≤ 24 Wet	≥ 36 Dry ≤ 24 Wet	≥ 36 Dry ≥ 36 Wet
Class P3	(●●)	-	-	Class P3	(●●●)	Class P4	Class P4	Class P3	-	-	-	-	Class P4
Class C2	(●●●)	-	-	Class C2	(●●●)	Class C3	Class C3	Class C2	-	-	-	-	Class C3
> 0.40 Asciutto > 0.40 Bagnato	> 0.40 Asciutto > 0.40 Bagnato	> 0.40 Asciutto < 0.40 Bagnato	> 0.40 Asciutto < 0.40 Bagnato	> 0.40 Asciutto > 0.40 Bagnato	> 0.40 Asciutto > 0.40 Bagnato	> 0.40 Asciutto > 0.40 Bagnato	> 0.40 Asciutto > 0.40 Bagnato	> 0.40 Asciutto > 0.40 Bagnato	> 0.40 Asciutto < 0.40 Bagnato	> 0.40 Asciutto < 0.40 Bagnato	> 0.40 Asciutto < 0.40 Bagnato	> 0.40 Asciutto < 0.40 Bagnato	> 0.40 Asciutto > 0.40 Bagnato
wet DCOF ≥ 0.50	wet DCOF ≥ 0.42	dry DCOF ≥ 0.42	dry DCOF ≥ 0.42	wet DCOF ≥ 0.50	wet DCOF ≥ 0.42	wet DCOF ≥ 0.55	wet DCOF ≥ 0.55	wet DCOF ≥ 0.50	dry DCOF ≥ 0.42	dry DCOF ≥ 0.42	dry DCOF ≥ 0.42	dry DCOF ≥ 0.42	wet DCOF ≥ 0.55

(●) PTV ≥ 36 Wet on demand - su richiesta (●●) P3 on demand - su richiesta (●●●) C2 on demand - su richiesta



A COMPLETE PRODUCT SYSTEM >

PRODUCT FINDER >

SURFACE RANGE >

COMPANY >

COLLECTIONS >

LARGE SIZES >

SLABS FOR COUNTERTOPS & FURNITURE >

SINKS & BATHROOM FURNISHING >

FACADES >

TECHNICAL SPECIFICATIONS >



Porcelain tiles technical features

Main technical specification table for Porcelain tiles, including categories like Regularity, Structural, Bulk, Surface, Thermal and hygrometric, Physical, Chemical, and Safety characteristics.

Technical feature - Caratteristiche tecniche - Características técnicas - Technische Daten - Características técnicas - Технические характеристики

Main technical specification table for Porcelain tiles, including categories like PRISM, TRUST, and VENTI BOOST.

(●), PTV ≥ 36 Wet on demand - su richiesta (●●), P3 on demand - su richiesta (●●●), C2 on demand - su richiesta

GLAZED PORCELAIN TILES GRES PORCELLANATO SMALTATO VENTI BOOST table with icons and detailed specifications.

A COMPLETE PRODUCT SYSTEM >

PRODUCT FINDER >

SURFACE RANGE >

COMPANY >

COLLECTIONS >

LARGE SIZES >

SLABS FOR COUNTERTOPS & FURNITURE >

SINKS & BATHROOM FURNISHING >

FACADES >

TECHNICAL SPECIFICATIONS >

# Wall Tiles

## Technical Specification

Complies with	EN 14411 (ISO 13006)	Appendix	L	Group	BIII
Conforme alla norma	EN 14411 (ISO 13006)	Appendice	L	Gruppo	BIII
Conforme à la norme	EN 14411 (ISO 13006)	Appendice	L	Groupe	BIII
Entsprechend	EN 14411 (ISO 13006)	Anhang	L	Gruppe	BIII
Conforme a la norma	EN 14411 (ISO 13006)	Apéndice	L	Grupo	BIII
Соответствует норме	EN 14411 (ISO 13006)	Приложение	L	Группа	BIII

- (\*) **The permissible deviation, in % or mm, of the average size for each tile (2 or 4 sides) from work size (WS).**  
Deviazione ammissibile, in % oppure mm, della dimensione media di ogni piastrella (2 oppure 4 lati) dalla dimensione di fabbricazione (WS).
- (\*\*) **The permissible deviation, in % or mm, of the average thickness for each tile from the work size thickness (WS).**  
Deviazione ammissibile, in % oppure mm, dello spessore medio di ogni piastrella dallo spessore riportato nella dimensione di fabbricazione (WS).
- (\*\*\*) **The maximum permissible deviation from straightness, in % or mm, related to the corresponding work sizes (WS).**  
Deviazione massima ammissibile di rettilineità, in % oppure mm, in rapporto alle dimensioni di fabbricazione (WS) corrispondenti.
- (\*\*\*\*) **The maximum permissible deviation from rectangularity, in % or mm, related to the corresponding work sizes (WS).**  
Deviazione massima ammissibile di ortogonalità, in % oppure mm, in rapporto alle dimensioni di fabbricazione (WS) corrispondenti.
- c.c. **The maximum permissible deviation from centre curvature, in % or mm, related to diagonal calculated from the work sizes (WS).**  
Deviazione massima ammissibile della curvatura del centro, in % oppure mm, in rapporto alla diagonale calcolata secondo le dimensioni di fabbricazione (WS).
- e.c. **The maximum permissible deviation from edge curvature, in % or mm, related to the corresponding work sizes (WS).**  
Deviazione massima ammissibile della curvatura dello spigolo, in % oppure mm, in rapporto alle dimensioni di fabbricazione (WS) corrispondenti.
- w. **The maximum permissible deviation from warpage, in % or mm, related to diagonal calculated from the work sizes (WS).**  
Deviazione massima ammissibile dello svergolamento, in % oppure mm, in rapporto alla diagonale calcolata secondo le dimensioni di fabbricazione (WS).

### Technical feature symbols

Dimensions Dimensioni Dimensions Maße Tamaño Размер	ISO 10545-2		<b>Length and width</b> / Lunghezza e larghezza (*) Longuer et largeur / Länge und Breite / Longitud y anchura / Размеры сторон
			<b>Thickness</b> / Spessore (**) Épaisseur / Stärke / Grosor / Толщина
			<b>Straightness of sides</b> / Rettilineità degli spigoli (***) Rectitude des aretes / Kantengeradheit / Rectilineidad de las aristas / Кривизна сторон
			<b>Rectangularity</b> / Ortogonalità (****) Orthogonalite / Rechtwinkligkeit / Ortogonalidad / Косоугольность
			<b>SURFACE FLATNESS</b> / PLANARITÀ Planimetrie / Ebenflächigkeit / Planaridad / Кривизна лицевой поверхности
	ISO 10545-3		<b>Water absorption</b> / Massa d'acqua assorbita Masse d'eau absorbée / Aufgenommene Wassermasse / Peso de agua absorbida / Водопоглощение
	ISO 10545-4		<b>BREAKING STRENGTH</b> / Sforzo di rottura Force de rupture / Bruchlast / Esfuerzo de ruptura / Усилие на излом
			<b>Modulus of rupture</b> / Resistenza alla flessione Résistance à la flexion / Biegefestigkeit / Resistencia a la flexión / Устойчивость к изгибу
	ISO 10545-8		<b>Coefficient of thermal linear expansion</b> / Coefficiente di dilatazione termica lineare Coefficient de dilatation thermique linéique / Lineare thermische Dehnung Coeficiente de dilatación térmica lineal / Коэффициент линейного расширения
Physical properties Proprietà fisiche Proprietes physiques Physikalische Eigenschaften Propiedades físicas Физические характеристики	ISO 10545-9		<b>Thermal shock resistance</b> / Resistenza agli sbalzi termici Résistance aux écarts de température / Temperaturwechselbeständigkeit Resistencia a los cambios de temperatura / Устойчивость к перепаду температур
	ISO 10545-10		<b>Moisture expansion (in mm/m)</b> / Dilatazione all'umidità (in mm/m) Dilatation à l'humidité (en mm/m) / Feuchtigkeitsausdehnung (in mm/m) Dilatación por la humedad (en mm/m) / Расширение под воздействием влаги (в мм/м)
	ISO 10545-11		<b>Crazing resistance</b> / Resistenza al cavillo Résistance aux craquelurés / Haarriss-Beständigkeit / Resistencia a grietas / Устойчивость эмали к кракелюру (старению)
	EN 1348		<b>Bond strength/adhesion for improved cementitious adhesives</b> / Adesione a trazione con adesivi cementizi migliorati Adhérence par traction avec des ciments-colle améliorés / Scherfestigkeit mit verbesserten zementhaltigen Klebern Adherencia a tracción con adhesivos cementosos mejorados Прочность на растяжение при приклеивании улучшенными цементными клеями
	-		<b>Reaction to fire</b> / Reazione al fuoco Réaction au feu / Brandverhalten / Reacción al fuego / Огнестойкость
Chemical properties Proprietà chimiche Proprietes chimiques Chemische eigenschaften Propiedades quimicas Химические характеристики	ISO 10545-13		<b>Resistance to household chemicals and swimming pool salts</b> Resistenza ai prodotti chimici di uso domestico ed agli additivi per piscina Résistance aux produits chimiques à usage domestique et aux adjuvants pour piscine Beständigkeit gegen Haushaltschemikalien und Badewasserzusätze Resistencia a los productos químicos de uso doméstico Стойкость к химикатам, используемым в быту и для бассейнов
			<b>Resistance to low concentrations of acids and alkalis</b> / Resistenza a basse concentrazioni di acidi e alcali Résistance aux acides et aux alcalis à basse concentration / Beständigkeit gegen niedrigkonzentrierte Säuren und Laugen Resistencia a los ácidos y bases de baja concentración / Сопротивление кислотам и щелочам низкой концентрации
			<b>Resistance to high concentrations of acids and alkalis</b> / Resistenza ad alte concentrazioni di acidi e alcali Résistance aux acides et aux alcalis à haute concentration / Beständigkeit gegen hochkonzentrierte Säuren und Laugen Resistencia a los ácidos y bases de alta concentración / Сопротивление кислотам и щелочам низкой концентрации
	ISO 10545-14		<b>Resistance to STAINING</b> / Resistenza alle macchie Résistance aux taches / Widerstand gegen Fleckenbildung / Resistencia a las manchas / Устойчивость эмали к загрязнению
	ISO 10545-15		<b>Release of dangerous substances: Cadmium (in mg/dm²) and Lead (in mg/dm²)</b> Rilascio di sostanze pericolose: Cadmio (in mg/dm²) e Piombo (in mg/dm²) Emission de substances dangereuses: Cadmium (mg/dm²) et Plomb (mg/dm²) Emission von gefährlichen Stoffen: Cadmium (mg/dm²) und Blei (mg/dm²) Emisión de sustancias peligrosas: Cadmio (mg/dm²) y Plomo (mg/dm²) Выделение вредных веществ: кадмия (в мг/дм²) и свинца (в мг/дм²)

Technical features - Caratteristiche tecniche - Caractéristiques techniques - Technische Daten - Características técnicas - Технические характеристики

INDEX



A COMPLETE PRODUCT SYSTEM



PRODUCT FINDER



SURFACE RANGE



COMPANY



COLLECTIONS



LARGE SIZES



SLABS FOR COUNTERTOPS & FURNITURE



SINKS & BATHROOM FURNISHING



FACADES



TECHNICAL SPECIFICATIONS





# atlasPLAN

## Technical Specification

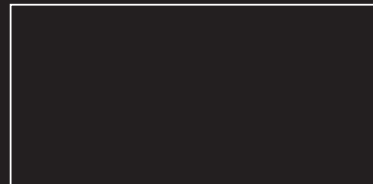

**162x324 cm - 63<sup>3</sup>/<sub>4</sub>"x127<sup>1</sup>/<sub>2</sub>"**  
SINGLE SLAB NON-RECTIFIED

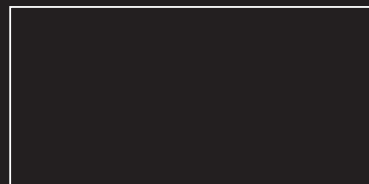

**160x320 cm - 63"x126"**  
RECTIFIED MONOCALIBER

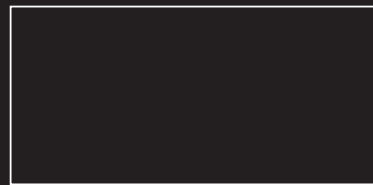

**159x324 cm - 62<sup>5</sup>/<sub>8</sub>"x127<sup>1</sup>/<sub>2</sub>"**  
SINGLE SLAB NON-RECTIFIED

Complies with	EN 14411 (ISO 13006)	Appendix	G	Group	Bla
Conforme alla norma	EN 14411 (ISO 13006)	Appendice	G	Gruppo	Bla
Conforme à la norme	EN 14411 (ISO 13006)	Appendice	G	Groupe	Bla
Entsprechend	EN 14411 (ISO 13006)	Anhang	G	Gruppe	Bla
Conforme a la norma	EN 14411 (ISO 13006)	Apéndice	G	Grupo	Bla
Соответствует норме	EN 14411 (ISO 13006)	Приложение	G	Группа	Bla

- (\*) **The permissible deviation, in % or mm, of the average size for each tile (2 or 4 sides) from work size (WS).**  
Deviazione ammissibile, in % oppure mm, della dimensione media di ogni piastrella (2 oppure 4 lati) dalla dimensione di fabbricazione (WS).
- (\*\*) **The permissible deviation, in % or mm, of the average thickness for each tile from the work size thickness (WS).**  
Deviazione ammissibile, in % oppure mm, dello spessore medio di ogni piastrella dallo spessore riportato nella dimensione di fabbricazione (WS).
- (\*\*\*) **The maximum permissible deviation from straightness, in % or mm, related to the corresponding work sizes (WS).**  
Deviazione massima ammissibile di rettilineità, in % oppure mm, in rapporto alle dimensioni di fabbricazione (WS) corrispondenti.
- (\*\*\*\*) **The maximum permissible deviation from rectangularity, in % or mm, related to the corresponding work sizes (WS).**  
Deviazione massima ammissibile di ortogonalità, in % oppure mm, in rapporto alle dimensioni di fabbricazione (WS) corrispondenti.
- c.c. **The maximum permissible deviation from centre curvature, in % or mm, related to diagonal calculated from the work sizes (WS).**  
Deviazione massima ammissibile della curvatura del centro, in % oppure mm, in rapporto alla diagonale calcolata secondo le dimensioni di fabbricazione (WS).
- e.c. **The maximum permissible deviation from edge curvature, in % or mm, related to the corresponding work sizes (WS).**  
Deviazione massima ammissibile della curvatura dello spigolo, in % oppure mm, in rapporto alle dimensioni di fabbricazione (WS) corrispondenti.
- w. **The maximum permissible deviation from warpage, in % or mm, related to diagonal calculated from the work sizes (WS).**  
Deviazione massima ammissibile dello svergolamento, in % oppure mm, in rapporto alla diagonale calcolata secondo le dimensioni di fabbricazione (WS).
- (1) **Determination of slip resistance of pedestrian surfaces; it does not cover sports surfaces and road surfaces for vehicles (skid resistance).**  
Determinazione della resistenza allo scivolamento delle superfici pedonabili; non si applica alle pavimentazioni sportive ed alle pavimentazioni stradali veicolari.
- (2) **Anti-slip performance is guaranteed at the time of delivery of the product.**  
Le prestazioni anti-slip vengono garantite al momento della consegna del prodotto.
- (3) **However, tiles with a DCOF of 0.42 or greater are not necessarily suitable for all projects. The specifier shall determine tiles appropriate for specific project conditions, considering by way of example, but not in limitation, type of use, traffic, expected contaminants, expected maintenance, expected wear, and manufacturers' guidelines and recommendations.**  
Per ulteriori dettagli, please refer to outdoor design general catalogue. Per maggiori informazioni riferirsi al catalogo generale Outdoor Design.
- (4) **For further details, please refer to outdoor design general catalogue.**
- (5) **Only for products with 20 mm thickness. Solo per prodotti a 20mm di spessore.**

### Technical features

		Requirements for nominal size N Requisiti per dimensione nominale N		162x324 cm - 63 <sup>3</sup> / <sub>4</sub> "x127 <sup>1</sup> / <sub>2</sub> " Non-Rectified			159x324 cm - 62 <sup>5</sup> / <sub>8</sub> "x127 <sup>1</sup> / <sub>2</sub> " Non-Rectified			160x320 cm - 63"x126" Rectified	
		N ≥ 15 cm		Silk	Matte Hammered Flamed Leathered	Polished Satin	Matte	Polished	Matte Hammered	Polished	
		(%)	(mm)								
Regularity characteristics	<b>Length and width</b> Lunghezza e larghezza	± 0.3 (*)	± 1 (*)	N.A.			N.A.		Suitable for Conforme		
	<b>Thickness</b> Spessore	± 5 (**)	± 0.5 (**)	Suitable for Conforme			Suitable for Conforme		Suitable for Conforme		
	<b>Straightness of sides</b> Rettilineità degli spigoli	± 0.3 (***)	± 0.8 (***)	N.A.			N.A.		Suitable for Conforme		
	<b>Rectangularity (Measurement only on short edges when L/l ≥ 3)</b> Ortogonalità (Misurazione da condurre solo sui lati corti quando L/l ≥ 3)	± 0.3 (****)	± 1.5 (****)	N.A.			N.A.		Suitable for Conforme		
	<b>Surface flatness</b> Planarità	c.c. ± 0.4 e.c. ± 0.4 w. ± 0.4	c.c. ± 1.8 e.c. ± 1.8 w. ± 1.8	Suitable for Conforme			Suitable for Conforme		Suitable for Conforme		
Structural characteristics	<b>Water absorption</b> Massa d'acqua assorbita	ISO 10545-3 ASTM C373-18	E <sub>s</sub> ≤ 0.5% Individual max 0.6% E <sub>s</sub> ≤ 0.5% Valore max singolo 0,6%	Requirement ANSI A137.1 Water Absorption Max ≤ 0.5%			≤ 0.1 %	≤ 0.1 %	≤ 0.1 %		
	<b>Breaking strength</b> Sforzo di rottura	ISO 10545-4	S ≥ 700 N for thickness < 7,5mm per spessore < 7,5mm	S ≥ 1300 N for thickness ≥ 7,5mm per spessore ≥ 7,5mm	6 mm -> S ≥ 1000N 12 mm -> S ≥ 3500N 20 mm -> S ≥ 10000N	20 mm -> S ≥ 10000N	S ≥ 1000N				
Bulk mechanical characteristics	<b>Modulus of rupture</b> Resistenza alla flessione	ISO 10545-4	R ≥ 35 N/mm <sup>2</sup>		R ≥ 40 N/mm <sup>2</sup>	R ≥ 40 N/mm <sup>2</sup>	R ≥ 40 N/mm <sup>2</sup>				
	<b>Impact resistance, as coefficient of restitution</b> Resistenza all'impatto, espresso come coefficiente di restituzione	ISO 10545-5	Declared value Valore dichiarato		≥ 0,55	≥ 0,55	≥ 0,55				
Surface mechanical characteristics	<b>Resistance to deep abrasion of unglazed tiles (removed volume)</b> Resistenza all'abrasione profonda delle piastrelle non smaltate (volume materiale asportato)	ISO 10545-6	≤ 175 mm <sup>3</sup>		Suitable for Conforme	Suitable for Conforme	Suitable for Conforme				
Thermal and hygrometric characteristics	<b>Coefficient of thermal linear expansion</b> Coefficiente di dilatazione termica lineare	ISO 10545-8	Declared value Valore dichiarato		≤ 7 MK <sup>-1</sup>	≤ 7 MK <sup>-1</sup>	≤ 7 MK <sup>-1</sup>				
	<b>Thermal shock resistance</b> Resistenza agli sbalzi termici	ISO 10545-9	Pass according to EN ISO 10545-1 Test superato in accordo con ISO 10545-1		Resistant Resiste	Resistant Resiste	Resistant Resiste				
	<b>Moisture expansion (in mm/m)</b> Dilatazione all'umidità (in mm/m)	ISO 10545-10	Declared value Valore dichiarato		≤ 0,01% (0,1mm/m)	≤ 0,01% (0,1mm/m)	≤ 0,01% (0,1mm/m)				
	<b>Frost resistance</b> Resistenza al gelo	ISO 10545-12	Pass according to EN ISO 10545-1 Test superato in accordo con ISO 10545-1		Resistant Resiste	Resistant Resiste	Resistant Resiste				
Physical properties	<b>Bond strength/adhesion for improved cementitious adhesives</b> Adesione a trazione con adesivi cementizi migliorati	EN 1348	Declared value Valore dichiarato		≥ 1,0 N/mm <sup>2</sup> (Class C2 - EN 12004)	≥ 1,0 N/mm <sup>2</sup> (Class C2 - EN 12004)	≥ 1,0 N/mm <sup>2</sup> (Class C2 - EN 12004)				
	<b>Reaction to fire</b> Reazione al fuoco	-	A1 or Afl		A1 without fiberglass - A2 with fiberglass	A1 without fiberglass - A2 with fiberglass	A1 - Afl				
Chemical characteristics	<b>Resistance to household chemicals and swimming pool salts</b> Resistenza ai prodotti chimici di uso domestico ed agli additivi per piscina	ISO 10545-13	Minimum Class B (B for unglazed tiles) Classe minima B (B per piastrelle non smaltate)		A	A	A				
	<b>Resistance to low concentrations of acids and alkalis</b> Resistenza a basse concentrazioni di acidi e alcali		Declared Class Classe dichiarata		LA	LA	LA				
	<b>Resistance to high concentrations of acids and alkalis</b> Resistenza ad alte concentrazioni di acidi e alcali		Declared Class Classe dichiarata		HA	HA	-	HA	-	HA	-
	<b>Resistance to staining</b> Resistenza alle macchie	ISO 10545-14	Declared Class Classe dichiarata		5	5	5				
Safety characteristics (1)(2)	<b>Release of dangerous substances: Cadmium (in mg/dm<sup>2</sup>) and Lead (in mg/dm<sup>2</sup>)</b> Rilascio di sostanze pericolose: Cadmio (in mg/dm <sup>2</sup> ) e Piombo (in mg/dm <sup>2</sup> )	ISO 10545-15	Declared value Valore dichiarato		≤ 0,01 mg/dm <sup>2</sup> Cd ≤ 0,1 mg/dm <sup>2</sup> Pb	≤ 0,01 mg/dm <sup>2</sup> Cd ≤ 0,1 mg/dm <sup>2</sup> Pb	-				
	<b>Shod Ramp Test</b> Metodo della rampa "calzato"	DIN EN 16165 ANNEX B (EX DIN 51130)	Declared Class Classe dichiarata		N.A.	N.A.	N.A.	N.A.	R9	N.C.	
	<b>Barefoot Ramp Test</b> Metodo della rampa a piedi nudi	DIN EN 16165 ANNEX A (EX DIN 51097)	Declared Class Classe dichiarata		N.A.	N.A.	N.A.	N.A.	A	-	
	<b>Coefficient of friction (COF)</b> Coefficiente di attrito	B.C.R.A. Rep. CEC/81	D. M. 236/89 del 14/06/89 μ > 0,40 per elemento scivolante cuoio su pavimentazione asciutta μ > 0,40 per elemento scivolante gomma dura su pavimentazione bagnata		N.A.	N.A.	N.A.	N.A.	> 0,40 Asciutto > 0,40 Bagnato	> 0,40 Asciutto < 0,40 Bagnato	
	<b>Dynamic coefficient of friction (DCOF)</b> Coefficiente di attrito dinamico	ANSI A 326.3	-		N.A.	N.A.	N.A.	N.A.	wet DCOF > 0,42	dry DCOF > 0,42	
Safety characteristics (1)(2)	<b>Resistance to scratching</b> Resistenza alla graffiatura	UNI EN 15186 2012 met.B	-		CEN/TS 16209 Class A CEN/TS 16209 Classe A	CEN/TS 16209 Class A CEN/TS 16209 Classe A	-		-		
	<b>Tendency to retain dirt</b> Tendenza a ritenere lo sporco	UNI 9300 2015	-		No visible change (5) Nessun cambiamento visibile (5)	No visible change (5) Nessun cambiamento visibile (5)	-		-		
	<b>Surface resistance to cold liquids</b> Resistenza delle superfici ai liquidi freddi	UNI EN 12720 2013	-		CEN/TS 16209 Class A CEN/TS 16209 Classe A	CEN/TS 16209 Class A CEN/TS 16209 Classe A	-		-		
	<b>Surface resistance to wet heat</b> Resistenza delle superfici al calore umido	UNI EN 12721 2013	-		CEN/TS 16209 Class A CEN/TS 16209 Classe A	CEN/TS 16209 Class A CEN/TS 16209 Classe A	-		-		
	<b>Surface resistance to dry heat</b> Resistenza delle superfici al calore secco	UNI EN 12722 2013	-		CEN/TS 16209 Class A CEN/TS 16209 Classe A	CEN/TS 16209 Class A CEN/TS 16209 Classe A	-		-		
	<b>Assessment of resistance to impact</b> Resistenza all'urto	ISO 4211-4:1988	-		Maximum drop height according to thickness. Altezza massima di caduta variabile in funzione dello spessore.	Maximum drop height according to thickness. Altezza massima di caduta variabile in funzione dello spessore.	-		-		



A COMPLETE  
PRODUCT  
SYSTEM



PRODUCT  
FINDER



SURFACE  
RANGE



COMPANY



COLLECTIONS



LARGE SIZES



SLABS FOR  
COUNTERTOPS  
& FURNITURE



SINKS &  
BATHROOM  
FURNISHING



FACADES



TECHNICAL  
SPECIFICATIONS



# The evolution of ceramic surfaces

DISCOVER MORE



VIDEO



**SOFT TO THE TOUCH**  
MORBIDO AL TATTO



**EXTREMELY SAFE**  
ESTREMAMENTE SICURA



**HYGIENIC AND EASY TO CLEAN**  
IGIENICA E FACILMENTE PULIBILE



**LONG-LASTING QUALITIES**  
QUALITÀ DUREVOLI NEL TEMPO

Surface section magnification (µm)\*  
Ingrandimento di una sezione di superficie (µm)\*

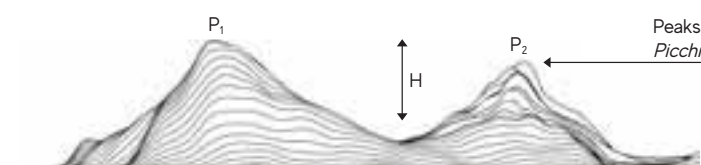

Traditional anti-slip surface  
Superficie anti-slip tradizionale

**P<sub>1</sub> P<sub>2</sub>** Same peaks → same slippery resistance  
Picchi invariati → uguale resistenza allo scivolamento

\* Charts not to scale, for illustrative purposes / Grafici non in scala, a scopo illustrativo

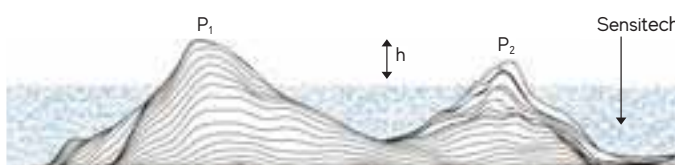

Sensitech surface  
Superficie Sensitech

**h < H** Reduced depth of valleys → smoother surface and greater ease of cleaning  
Minore profondità degli avvallamenti → percezione di superficie più liscia e maggiore facilità di pulizia

The constant research of Atlas Concorde Laboratories has led to the creation of Sensitech, the porcelain tile surface made using a production method patented in Italy. Sensitech is a high-tech surface for interiors that combines high slip resistance with an unrivaled soft touch, which also makes it resistant to dirt and easier to clean. With Sensitech the meaning of surface evolves and takes on a reassuring, protective, and pleasantly refined touch, making architectural spaces increasingly comfortable and appealing.

Dalla costante ricerca dei Laboratori Atlas Concorde nasce Sensitech, la superficie in gres porcellanato realizzata con metodo produttivo brevettato in Italia. Una superficie ad alto coefficiente tecnologico per gli ambienti interni, in grado di coniugare elevate prestazioni di resistenza allo scivolamento ad un'inedita morbidezza tattile, che la rende anche resistente allo sporco e più facile da pulire. Con Sensitech il significato di superficie si evolve e assume un tocco rassicurante, protettivo e piacevolmente raffinato, rendendo gli spazi architettonici sempre più confortevoli ed appaganti.

La recherche constante des Laboratoires Atlas Concorde a créé Sensitech, la surface en grès cérame pour intérieur réalisée avec un procédé de fabrication breveté en Italie. Une surface à haut coefficient technologique pour les espaces intérieurs, en mesure de conjuguer de hautes performances de résistance à la glissance avec une douceur tactile inédite, qui la rend également résistante aux salissures et plus facile à nettoyer. Avec Sensitech, c'est l'acception même d'une surface qui évolue en offrant une caractéristique rassurante, protectrice et agréablement raffinée, qui rend les espaces architecturaux de plus en plus confortables et agréables à vivre.

Durch kontinuierliche Forschung der Atlas Concorde Laboratorien entsteht Sensitech, die Feinsteinzeugoberfläche, die mit einem in Italien patentierten Herstellungsverfahren produziert wird. Eine Hightec-Oberfläche für Innenräume, die hohe Rutschfestigkeit mit unerwartet weicher Haptik verbindet, welche sie auch schmutzunempfindlicher und reinigungsfreundlicher macht. Mit Sensitech erreicht die Oberfläche ein ganz neues Niveau in Sachen Zuverlässigkeit, Schutz und Schönheit. Und macht damit unsere Räumlichkeiten noch attraktiver und komfortabler.

De la constante investigación de los Laboratorios Atlas Concorde nace Sensitech, la superficie de gres porcelánico para interiores realizada con un método de producción patentado en Italia. Una superficie de alto coeficiente tecnológico capaz de combinar un alto rendimiento de resistencia al deslizamiento con una suavidad táctil sin precedentes, que además la vuelve resistente a la suciedad y más fácil de limpiar. Con Sensitech, el significado de la superficie evoluciona y adquiere un toque tranquilizador, protector y agradablemente refinado, haciendo que los espacios arquitectónicos sean cada vez más cómodos y satisfactorios.

В результате исследований, выполненных в лабораториях Atlas Concorde, появилась керамогранитная поверхность Sensitech. Новая поверхность с высокими техническими показателями для интерьеров, которая сочетает отличное сопротивление скольжению и удивительную мягкость на ощупь, устойчива к загрязнениям и крайне проста в чистке и уходе. Поверхность Sensitech – на новом витке технической эволюции, она безопасна, приятна, изысканна и делает пространства уютнее и удобнее.

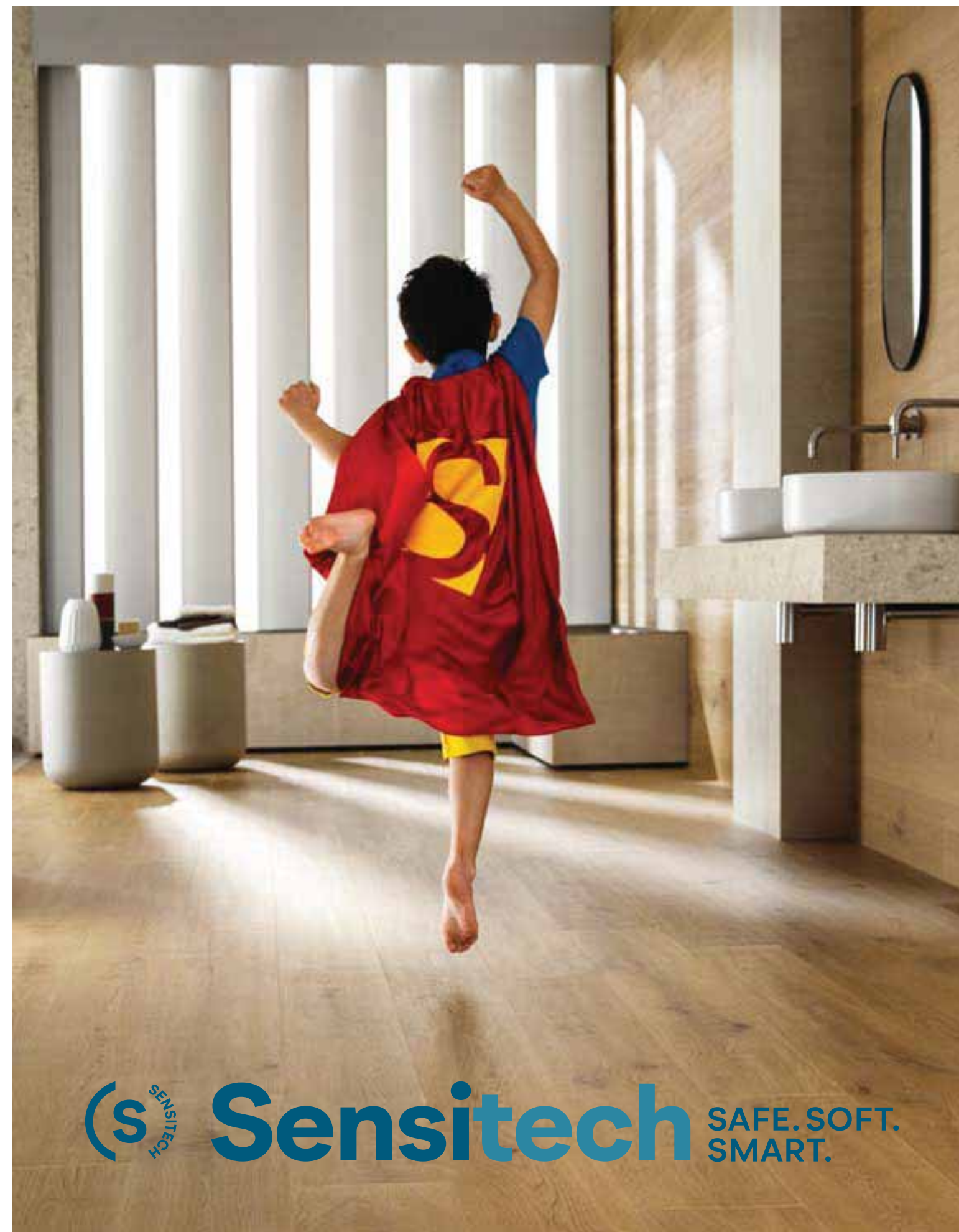

INDEX



A COMPLETE PRODUCT SYSTEM



PRODUCT FINDER



SURFACE RANGE



COMPANY



COLLECTIONS



LARGE SIZES



SLABS FOR COUNTERTOPS & FURNITURE



SINKS & BATHROOM FURNISHING



FACADES



TECHNICAL SPECIFICATIONS



### Porcelain tiles anti-slip classification

SAFETY CHARACTERISTICS CARATTERISTICHE DI SICUREZZA *										
Serie / Series Série / Serie Серия / Серия	Superficie / Surface Surface / Oberfläche Superficie / Поверхность	Shod Ramp Test Metodo della rampa "calzato" DIN EN 16165 ANNEX B (EX DIN 51130) *				Barefoot Ramp Test Metodo della rampa a piedi nudi DIN EN 16165 ANNEX A (EX DIN 51097) *			Pendulum Friction Test Metodo del pendolo BS EN 16165 ANNEX C (EX BS 7976) *	
		R9	R10	R11	R12	A	B	C	≥ 36 Dry ≥ 36 Wet	≥ 36 Dry ≥ 36 Wet
Aix	Matte Sensitech		x				x			x
Axi	Grip			x				x		x
Blaze	Matte		x				x			x
Boost	Matte 6 mm	x				x				(●)
	Matte Sensitech		x				x			x
	Matte 6 mm	x				x				(●)
Boost Mix	Grip			x				x		x
	Matte Sensitech		x				x			(●)
	Matte 6 mm	x				x				(●)
Boost Natural	Grip			x				x		x
	Matte Sensitech		x				x			(●)
	Matte 6 mm	x				x				(●)
Boost Pro	Grip			x				x		x
	Matte Sensitech		x				x			(●)
	Matte 6 mm	x				x				(●)
Boost Stone	Grip			x				x		x
	Matte Sensitech		x				x			(●)
	Matte 6 mm	x				x				(●)
Brave	Grip		x					x		x
	Matte Sensitech		x					x		x
Dwell	Matte	x				+				(●)
Entice	Matte Sensitech (Natural)		x				x			x
	Matte (Elegant)	x				x				(●)
Etic	Grip			x				x		x
	Matte	x				+				(●)
Etic Pro	Matte	x				+				(●)
	Grip			x				x		x
Exence	Matte Sensitech		x					x		x
	Grip			x				x		x
Heartwood	Matte Sensitech		x				x			x
Klif	Matte Sensitech		x				x			x
	Grip			x				x		x
Kone	Matte Sensitech		x				x			x
	Grip			+			+			x
Lims	Matte Sensitech		x				x			x
	Matte 6 mm	x				x				(●)
Marvel	Grip			x				x		x
	Matte Sensitech		x				x			(●)
Marvel Dream	Matte 6 mm	x				x				(●)
	Matte Sensitech		x				x			x
Marvel Edge	Matte Sensitech		x				x			x
	Matte Sensitech		x				x			x
Marvel Gems	Matte Sensitech		x				x			x
	Matte Sensitech		x				x			x
Marvel Pro	Matte 6 mm	x				x				(●)
	Textured			x				x		x
Marvel Shine	Matte Sensitech		x				x			x
Marvel Stone	Matte Sensitech		x				x			x
	Matte 6 mm	x				x				(●)
Marvel Travertine	Matte / Matte Sensitech		x				x			x
	Matte 6 mm	x				x				(●)
Marvel X	Grip			x				x		x
Nid	Matte Sensitech		x				x			x
	Matte		x			x				x
Norde	Matte Sensitech		x				x			x
	Grip			x				x		x
Prism	Roccia				x			x		x
	Matte Sensitech		x				x			x
Trust	Matte 6 mm	x				x				(●)
	Grip			x				x		x
Venti Boost	Matte Sensitech		x				x			x
Matte			x			x				x
Outdoor ± 20 mm				x				x		x

\* Determination of slip resistance of pedestrian surfaces; it does not cover sports surfaces and road surfaces for vehicles (skid resistance). - Determinazione della resistenza allo scivolamento delle superfici pedonabili; non si applica alle pavimentazioni sportive ed alle pavimentazioni stradali veicolari. - Détermination de la résistance au glissement des surfaces piétonnes; elle ne s'applique pas aux sols sportifs, ni aux revêtements routiers. - Bestimmung der Rutschfestigkeit von begehbaren Oberflächen; gilt nicht für Sportböden und Straßenböden. - Determinación de la resistencia al deslizamiento de las superficies peatonales; no se aplica a las pavimentaciones deportivas y calzadas. - Установление сопротивления скольжению напольных покрытий; не применяется к спортивным напольным покрытиям и дорожным покрытиям, предназначенным для проезда транспорта.

Anti-slip classification - Classificazione non-slip - Classification non-slip - Non-Slip Klassifizierung - Clasificación non-slip - сопротивление скольжению

SAFETY CHARACTERISTICS CARATTERISTICHE DI SICUREZZA *													
Pendulum Friction Test Metodo del pendolo AS 4586				Pendulum Friction Test Metodo del pendolo UNE 41907 EX:2017 *			Coefficient of friction COF Coefficiente di attrito COF B.C.R.A. Rep. CEC/81		Dynamic coefficient of friction (DCOF) Coefficiente di attrito dinamico DCOF ANSI A 326,3			Superficie / Surface Surface / Oberfläche Superficie / Поверхность	Serie / Series Série / Serie Серия / Серия
Class P1	Class P2	Class P3	Class P4	Class C1	Class C2	Class C3	>0,40 Asciutto >0,40 Bagnato	wet DCOF ≥ 0,42	wet DCOF ≥ 0,50	wet DCOF ≥ 0,55			
		x			x		x				x	Matte Sensitech	Aix
			x			x	x				x	Grip	Axi
		x					x				x	Matte	Blaze
	(●●)				(●●●)		x			x	Matte 6 mm	Boost	
		x					x				Matte Sensitech		
	(●●)				(●●●)		x				Matte 6 mm		
			x				x			x	Grip	Boost Mix	
	(●●)				(●●●)		x				Matte Sensitech		
		x				x	x				Matte 6 mm		
	(●●)				(●●●)		x				Matte Sensitech	Boost Natural	
		x					x				Matte 6 mm		
			x				x			x	Grip		
	(●●)				(●●●)		x				Matte Sensitech	Boost Pro	
		x					x				Matte 6 mm		
			x				x			x	Grip		
	(●●)				(●●●)		x				Matte Sensitech	Boost Stone	
		x					x				Matte 6 mm		
			x				x			x	Grip		
		x					x				Matte Sensitech	Brave	
			x				x			x	Matte Sensitech		
	(●●)				(●●●)		x			On demand	Grip		
	(●●)	x			(●●●)		x				Matte	Dwell	
			x				x			x	Matte Sensitech (Natural)		
	(●●)				(●●●)		x				Matte (Elegant)	Entice	
			x				x				Grip		
	(●●)				(●●●)		x				Matte	Etic	
	(●●)				(●●●)		x				Matte		
			x				x				Grip	Etic Pro	
							x				Matte Sensitech		
			x				x			x	Grip	Exence	
							x				Matte Sensitech		
		x					x			x	Grip	Heartwood	
			x				x				Matte Sensitech		
			x				x				Matte Sensitech	Klif	
							x				Grip		
			x				x				Matte Sensitech	Kone	
							x				Grip		
		x					x				Matte Sensitech	Lims	
	(●●)						x				Matte 6 mm		
			x				x				Grip	Marvel	
	(●●)						x				Matte Sensitech		
		x					x				Matte 6 mm	Marvel Dream	
	(●●)						x				Matte Sensitech		
			x				x				Matte 6 mm	Marvel Edge	
		x					x				Matte Sensitech		
			x				x				Matte Sensitech	Marvel Gems	
							x				Matte Sensitech		
	(●●)						x				Matte 6 mm	Marvel Pro	
							x				Textured		
			x				x				Matte Sensitech	Marvel Shine	
							x				Matte Sensitech		
	(●●)						x				Matte 6 mm	Marvel Stone	
	(●●)						x				Matte / Matte Sensitech		
		x					x				Matte 6 mm	Marvel Travertine	
							x				Grip		
			x				x				Matte Sensitech	Marvel X	
							x				Matte		
							x				Matte Sensitech	Norde	
							x				Grip		
							x				Roccia	Prism	
	(●●)						x				Matte Sensitech		
							x				Matte 6 mm	Trust	
							x				Grip		
			x				x				Matte Sensitech	Venti Boost	
							x				Matte		
Outdoor ± 20 mm				x			x				x	Outdoor ± 20mm	

\* Anti-slip performance is guaranteed at the time of delivery of the product. - Le prestazioni anti-slip vengono garantite al momento della consegna del prodotto.  
 (●), PTV ≥ 36 Wet on demand - su richiesta (●●), P3 on demand - su richiesta (●●●), C2 on demand - su richiesta

A COMPLETE PRODUCT SYSTEM >

PRODUCT FINDER >

SURFACE RANGE >

COMPANY >

COLLECTIONS >

LARGE SIZES >

SLABS FOR COUNTERTOPS & FURNITURE >

SINKS & BATHROOM FURNISHING >

FACADES >

TECHNICAL SPECIFICATIONS >

## Laying suggestions - cleaning and maintenance

### 1. LAYING

Before starting the installation process, make sure the laying surface is well cured, flat and completely clean and that the material available is sufficient in quantity and has the right tone and size.

### 2 CHOICE OF ADHESIVE

The use of an appropriate adhesive is essential for a successful installation. For the installation of ceramic tiles, you should follow the laying instructions provided by leading adhesives manufacturers.

You should choose the most suitable adhesive on the basis of the following factors:

- laying surface
- type and size of tile
- use of tiled surface (floor/wall; indoor/outdoor)
- weather conditions at the time of laying
- waiting time before the ceramic surface can be used

USE Laying surface	TYPE OF TILE Type	SIZE (cm)	RECOMMENDED ADHESIVES - European Standards EN 12004	
			Normal Set	Rapid set
<b>INDOOR FLOORS</b>				
Cementitious screeds Existing cement floors (cement concrete, bush-hammered) Anhydrite screeds (following application of a suitable primer) Heating floors Existing ceramic, terrazzo and natural stone floors Waterproofing in bathrooms	porcelain tiles	< 30x30 cm	Improved cementitious adhesives with long open time (Class C2E).	Improved cementitious adhesives, slip resistant and deformable (Class C2FT - S1). ●
		≥ 30x30 cm < 60x60 cm	Improved cementitious adhesives resistant to slip and with long open time (Class C2TE).	Improved cementitious adhesives, slip resistant and deformable (Class C2FT - S1). ●
		≥ 60x60 cm	Improved cementitious adhesives with long open time and deformable (Class C2E - S1).	Improved cementitious adhesives, slip resistant and deformable (Class C2FT - S1). ●
<b>INDOOR WALL TILES</b>				
Cementitious plaster or mortar Plaster (plaster or panels, following application of a suitable primer) Painted walls Cast concrete (Following application of primer on gypsum-based joints) Plasterboard Waterproofing in bathrooms and showers Existing ceramic tiles	porcelain tiles	any size	Improved cementitious adhesives resistant to slip and with long open time (Class C2TE).	Improved cementitious adhesives, slip resistant and deformable (Class C2FT - S1). ●
		< 30x30 cm	Improved cementitious adhesives resistant to slip and with long open time (Class C2TE).	Improved cementitious adhesives, slip resistant and deformable (Class C2FT - S1). ●
		≥ 30x30 cm < 60x60 cm	Improved cementitious adhesives resistant to slip and with long open time (Class C2TE).	Improved cementitious adhesives, slip resistant and deformable (Class C2FT - S1). ●
		≥ 60x60 cm	Improved cementitious adhesives resistant to slip with long open time and deformable (Class C2TE - S1).	Improved cementitious adhesives, slip resistant and deformable (Class C2FT - S1). ●
<b>OUTDOOR FLOORS</b>				
Cementitious screeds Concrete floor Layers of waterproofing	porcelain tiles	< 30x30 cm	A Improved cementitious adhesives resistant to slip and with long open time (Class C2TE).	Improved cementitious adhesives, slip resistant and deformable (Class C2FT - S1). ●
		≤ 30x30 cm < 60x60 cm	Improved cementitious adhesives resistant to slip with long open time and deformable (Class C2TE - S1).	Improved cementitious adhesives, slip resistant and deformable (Class C2FT - S1). ●
		≥ 60x60 cm	Improved cementitious adhesives with long open time and highly deformable (Class C2E - S2).	Improved cementitious adhesives with long open time and highly deformable (Class C2FE - S2). ●
<b>OUTDOOR WALLS</b>				
Cementitious plaster Concrete cast in situ or prefabricated	porcelain tiles	< 30x30 cm	Improved cementitious adhesives resistant to slip with long open time and deformable (Class C2TE - S1).	Improved cementitious adhesives, slip resistant and deformable (Class C2FT - S1). ●
		≥ 30x30 cm < 60x60 cm ●	Improved cementitious adhesives resistant to slip with long open time and deformable (Class C2TE - S1).	Improved cementitious adhesives, slip resistant and deformable (Class C2FT - S1). ●
		≥ 60x60 cm ●●	Improved cementitious adhesives with long open time and highly deformable (Class C2E - S2).	Improved and highly deformable cementitious adhesives (Class C2F - S2). ●

- For large size tiles laid at a height of more than three meters, certain international regulations specify that tiles should be laid using a mixed system of adhesive and mechanical fixtures chosen in relation to the weight of the tile, height of the tiling and site conditions.
- For tiles with a side measuring more than 30 cm laid at heights of more than three meters, certain international regulations specify the use of an additional mechanical anchor that ensures the retention of the tile in case of accidental detachment, to be chosen in relation to the weight of the tile, the height of the tiling and the site conditions.

### 3. LAYING THE TILES

Installation should be performed by qualified personnel using the proper tools. The laying of the material should be checked before the adhesive is dry so that any corrections can be made. In any case, Atlas Concorde does not recommend installation without joints or joints smaller than 2 mm.

When laying tiles with a side longer than 60 cm and in any case for commercial indoor environments or outdoors it is essential to spread the adhesive using double buttering, applying the adhesive in a linear method parallel to the short side both on the substrate and on the back of the tile, thus ensuring perfect adhesion between the tile and substrate. To minimize the unevenness of the tiles both on the floor and on the wall it is recommended to use "easy installation systems" with spacers and levelers. Spread the adhesive using a suitably toothed spatula.

#### 3A. LAYING RECTANGULAR FORMATS

For straight courses of rectangular formats, the maximum offset between tiles must not exceed 1/3 of the length of the adjacent side.

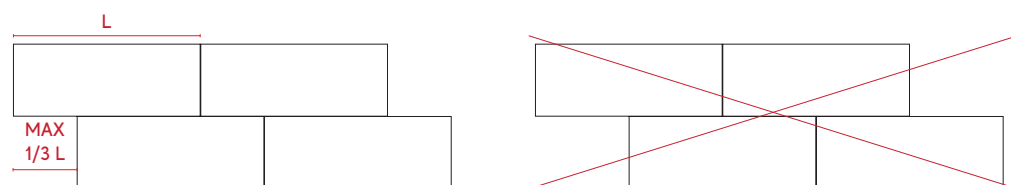

## PORCELAIN & WALL TILES

### 4. SQUARE OR PERPENDICULAR CUTS

To perform square or perpendicular cuts, it's best to first drill circular holes near the corners of the hole and then connect them with linear cuts, which will relax the tension at the corners of the tile.

### 5. JOINTS AND GROUTING

Before filling the joints, it is recommended to wait until the adhesive is completely dry and to ensure that the joints are free of all traces of adhesive and/or dust. In any case, Atlas Concorde does not recommend installation without joints or joints smaller than 2 mm. For joints in a color that contrasts with the tiles, it is recommended to test the grout in a small, hidden area. You should follow the instructions provided by leading grout manufacturers.

USE	RECOMMENDED GROUTS - EUROPEAN STANDARDS EN 13888
Residential interiors	Improved cementitious mortars for joints (Class CG2)
Damp interiors (bathrooms, showers) and outdoors	Improved cementitious mortars for joints with low water absorption (CG2 WA)
Commercial premises	Improved cementitious mortars for joints with high resistance to abrasion (Class CG2 A)
Premises requiring total hygiene and resistance to chemical agents (swimming pools, kitchen work surfaces, food industry, hospitals, supermarkets, etc).	Epoxy mortars (Class RG).

### 5A. ELIMINATION OF EXCESS GROUT

To correctly and easily eliminate excess grout, follow the instructions given by the grout manufacturer. In general, proceed as follows:

#### Cementitious grouts

When the grout becomes opaque (normally after 10-20 minutes), clean with a hard cellulose sponge using movements on a diagonal to the joints. It is important to respect the drying time to avoid removing the grout from the joints.

#### Epoxy grouts

When the mixture is still fresh, wet the surface with plenty of water, emulsifying with a pad like Scotch-Brite®, paying attention not to empty the joints.

The residual grout liquid can be removed with a hard cellulose sponge (to be replaced when excessively soaked with resin).

It is vital to remove epoxy grout rapidly before it starts hardening as it is extremely difficult to remove subsequently. If the epoxy grout has started to harden, try adding 10% alcohol to the washing water.

### 6. CLEANING AND MAINTENANCE

#### 6A. FINAL SITE CLEANING

The work site is considered finished when it is cleared of any tools/materials used for the job. To reduce the risk of damage to the tiled surface, it is necessary to protect it and avoid the presence of abrasive materials.

After a few days, eliminate residues with a commercial Scotch-Brite® pad, brush or single brush floor cleaner (for large surfaces).

For walls, use a neutral detergent in hot water.

For floors, use a mild acid wash diluted according to the type of surface (smooth or textured). It is important to protect marble or metal inserts previously with adhesive tape. Rinse with abundant clean water to eliminate all marks or residues from the joints.

If necessary, repeat the acid wash at a higher concentration, unless there are marble or metal inserts. Do not use diluted commercially-available acids.

#### 6B. ROUTINE MAINTENANCE

You are recommended to use ordinary neutral detergent diluted in water.

Avoid using acid or alkaline products, waxes and/or impregnants and metal pads (iron or steel sponges).

In the event of heavy dirt or particularly textured surfaces, use an alkaline detergent and rinse after washing.

For large surfaces, the use of a floor washing machine is recommended.

#### 6C. UNSCHEDULED MAINTENANCE

In the event of dirt resistant to the ordinary cleaning, use a suitable detergent for the particular kind of dirt.

TYPE OF DIRT (resistant to ordinary maintenance)	DETERGENT/SOLVENT
Coal, lime efflorescence, chalk, metal marks, rust, graphite, emulsion paint	Acid detergents*
Coca cola, coffee, wine, beer, ice cream	Alkaline detergents
Resin, silicon or mechanical oils, candle wax, paint	Solvents
Tire marks, sole marks, suction cup marks	Alkaline detergent in an abrasive paste

\* Important: Acid products may corrode marble, granite, natural stone and metal. Avoid using in the presence of decoration or inserts in these materials

The cleaning characteristics of the materials may vary significantly depending on the laying method, conditions of use, type of surface and environment. Generally speaking, the higher the non-slip characteristics of the tiles, the more difficult they are to clean.

The maintenance and cleaning operative should always test each cleaning method empirically in advance (if possible on a piece of the material not laid)

In the case of particularly heavy use (for example, mechanical workshops or environments with a heavy presence of oily residues and tire marks), incorrect laying or inappropriate cleaning, Atlas Concorde declines all responsibility for the effectiveness of cleaning and maintenance operations.

Atlas Concorde cannot, under any circumstances, be held responsible for events, damage or defects caused by incorrect laying, negligent cleaning and maintenance or the use of materials and adhesives inappropriate for the use.

## Suggerimenti per la posa, pulizia e manutenzione

### 1. POSA IN OPERA

Prima di iniziare la posa, si raccomanda di assicurarsi che la superficie di appoggio sia sufficientemente stagionata, planare e ben pulita e che la fornitura di materiale sia adeguata e sufficiente per quantità, tono e calibro.

### 2. SCELTA DELL'ADESIVO

L'utilizzo di un adesivo appropriato è di fondamentale importanza per la posa. Si raccomanda di seguire le indicazioni dei migliori produttori di adesivi per la posa di piastrelle ceramiche. In generale, l'adesivo più adeguato si individua considerando i seguenti fattori:

- tipo di supporto
- tipologia e formato delle piastrelle
- destinazione d'uso del rivestimento ceramico (pavimento/rivestimento; interno/esterno)
- condizioni climatiche all'atto della posa
- tempi a disposizione per la messa in esercizio del rivestimento ceramico

DESTINAZIONE D'USO Tipo di supporto	TIPO DI PIASTRELLE Tipologia	FORMATO (cm)	ADESIVI CONSIGLIATI - Normativa Europea EN 12004	
			Pres a normale	Pres a rapida
<b>PAVIMENTI INTERNI</b>				
Massetti cementizi Pavimento in cemento esistenti (Battuto, bocciardato)	grès porcellanato	< 30x30 cm	Adesivi cementizi migliorati e a tempo aperto allungato (classe C2E).	Adesivi cementizi migliorati resistenti allo scivolamento e deformabili (classe C2FT - S1). ●
Massetti in anidrite (Previa applicazione di opportuno primer)		≥ 30x30 cm < 60x60 cm	Adesivi cementizi migliorati, resistenti allo scivolamento e a tempo aperto allungato (classe C2TE).	Adesivi cementizi migliorati resistenti allo scivolamento e deformabili (classe C2FT - S1). ●
Massetti riscaldanti Pavimenti in ceramica, marmette e pietre naturali esistenti Impermeabilizzazione in bagni		≥ 60x60 cm	Adesivi cementizi migliorati, a tempo aperto allungato e deformabili (classe C2E - S1).	Adesivi cementizi migliorati resistenti allo scivolamento e deformabile (classe C2FT - S1). ●
<b>RIVESTIMENTI INTERNI</b>				
Intonaco cementizio o malta Gesso (Intonaci o pannelli previa applicazionedi opportuno primer)	grès porcellanato	tutti formati	Adesivi cementizi migliorati, resistenti allo scivolamento e a tempo aperto allungato (classe C2TE).	Adesivi cementizi migliorati resistenti allo scivolamento e deformabili (classe C2FT - S1). ●
Calcestruzzo di getto Gesso cartonato (Previa applicazione di primer sulle giunture a base gesso)		< 30x30 cm	Adesivi cementizi migliorati, resistenti allo scivolamento e a tempo aperto allungato (classe C2TE).	Adesivi cementizi migliorati resistenti allo scivolamento e deformabili (classe C2FT - S1). ●
Impermeabilizzazioni in bagni e docce Piastrlle ceramiche esistenti		≥ 30x30 cm < 60x60 cm	Adesivi cementizi migliorati, resistenti allo scivolamento e a tempo aperto allungato (classe C2TE).	Adesivi cementizi migliorati resistenti allo scivolamento e deformabili (classe C2FT - S1). ●
		≥ 60x60 cm	Adesivi cementizi migliorati, resistenti allo scivolamento, a tempo aperto allungato e deformabili (classe C2TE - S1).	Adesivi cementizi migliorati resistenti allo scivolamento e deformabili (classe C2FT - S1). ●
<b>PAVIMENTI ESTERNI</b>				
Massetti cementizi Soletta in calcestruzzo Strati di impermeabilizzazione	grès porcellanato	< 30x30 cm	Adesivi cementizi migliorati, resistenti allo scivolamento e a tempo aperto allungato (classe C2TE).	Adesivi cementizi migliorati resistenti allo scivolamento e deformabili (classe C2FT - S1). ●
		≤ 30x30 cm < 60x60 cm	Adesivi cementizi migliorati, resistenti allo scivolamento, a tempo aperto allungato e deformabili (classe C2TE - S1).	Adesivi cementizi migliorati resistenti allo scivolamento e deformabili (classe C2FT - S1). ●
		≥ 60x60 cm	Adesivi cementizi migliorati, a tempo aperto allungato e altamente deformabili (classe C2E - S2).	Adesivi cementizi migliorati a tempo aperto allungato e altamente deformabile (classe C2FE - S2). ●
<b>RIVESTIMENTI ESTERNI</b>				
Intonaco cementizio Calcestruzzo gettato in opera o prefabbricato	grès porcellanato	< 30x30 cm	Adesivi cementizi migliorati, resistenti allo scivolamento, a tempo aperto allungato e deformabili (classe C2TE - S1).	Adesivi cementizi migliorati resistenti allo scivolamento e deformabili (classe C2FT - S1). ●
		≥ 30x30 cm < 60x60 cm ●●	Adesivi cementizi migliorati, resistenti allo scivolamento, a tempo aperto allungato e deformabili (classe C2TE - S1).	Adesivi cementizi migliorati resistenti allo scivolamento e deformabili (classe C2FT - S1). ●
		≥ 60x60 cm ●●	Adesivi cementizi migliorati, a tempo aperto allungato e altamente deformabili (classe C2E - S2).	Adesivi cementizi migliorati e altamente deformabili (classe C2F - S2). ●

- Nel caso di posa in condizioni di basse temperature oppure qualora sia necessario mettere in esercizio rapidamente il rivestimento ceramico è preferibile l'utilizzo di adesivi cementizi migliorati a presa rapida (Classe C2F - EN 12004).
- Nel caso di piastrelle con un lato maggiore di 30 cm posate ad altezze superiori ai 3 metri, alcune normative internazionali prevedono l'utilizzo di un ancoraggio meccanico supplementare che assicuri la ritenzione della piastrella in caso accidentale di distacco, da scegliere in relazione al peso della piastrella, all'altezza del rivestimento ed alle condizioni del cantiere.

### 3. STESURA DEGLI ADESIVI E POSA DELLE PIASTRELLE:

La posa deve essere effettuata da personale qualificato con l'ausilio di attrezzi adeguati. È opportuno verificare la posa del materiale prima che il collante sia secco in modo da poter provvedere ad eventuali correzioni.

Atlas Concorde sconsiglia in ogni caso la posa a giunto unito o posa con fughe inferiori a 2mm.

Nel caso di posa di piastrelle con un lato maggiore di 60cm e in ogni caso per ambienti interni commerciali oppure all'esterno è fondamentale stendere l'adesivo con il sistema della doppia spalmatura applicando la colla linearmente in direzione parallela al lato corto sia sul supporto di posa sia sul retro della piastrella, garantendo così la perfetta aderenza all'interfaccia piastrella-supporto.

Per minimizzare i dislivelli della posa sia a pavimento che a rivestimento si raccomanda l'adozione di "sistemi di posa facilitata" con distanziatori e livellatori che possono essere provvisti di pedane anti-sbeccature e anti-graffio nel caso in cui si posino rivestimenti smaltati in pasta bianca e/o gres con finitura lappate.

Nel caso particolare di rivestimenti tridimensionali si consiglia l'utilizzo dei sistemi di livellamento a vite, alternativi a quelli a cuneo.

### 3A. POSA DI FORMATI RETTANGOLARI

Nel caso di posa "a correre" di formati rettangolari il massimo sfalsamento tra piastrelle non deve superare 1/3 della lunghezza del lato adiacente.

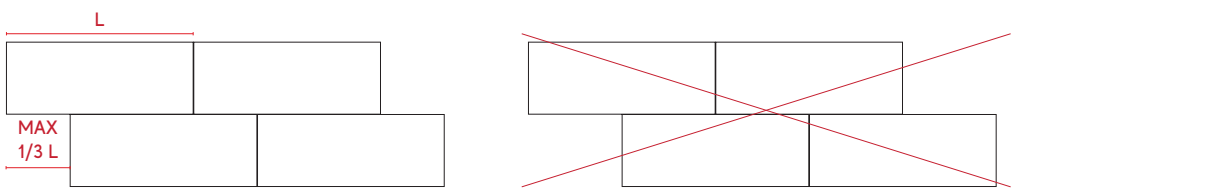

### 4. ESECUZIONI DI TAGLI QUADRATI O SQUADRI

Per eseguite tagli quadrati o squadri si consiglia di eseguire inizialmente fori circolari in prossimità dei vertici del taglio e collegarli in un secondo momento attraverso tagli lineari, in questo modo si avrà un rilassamento delle tensioni sui vertici della piastrella tagliata.

### 5. FUGA E STUCCATURA

Prima di riempire le fughe si consiglia di attendere fino a completa asciugatura del collante e di assicurarsi che i giunti di posano siano liberi da ogni traccia di collante e/o polveri. Atlas Concorde sconsiglia in ogni caso la posa a giunto unito o posa con fughe inferiori a 2mm. Per fughe in contrasto cromatico con le piastrelle si consiglia di testare il fugante in un'area circoscritta e nascosta della posa.

Si raccomanda di seguire le indicazioni dei migliori produttori di stucchi per fughe.

DESTINAZIONE D'USO	STUCCHI CONSIGLIATI - Normativa Europea EN 13888
Ambienti interni residenziali	Malte cementizie per fughe migliorate (Classe CG2)
Ambienti umidi interni (bagni, docce) ed ambienti esterni	Malte cementizie per fughe migliorate con assorbimento di acqua ridotto (classe CG2 WA)
Ambienti ad uso commerciale	Malte cementizie per fughe migliorate con elevata resistenza all'abrasione (classe CG2 A)
Ambienti in cui sia richiesta totale igiene e resistenza agli agenti chimici (piscine, piani di lavoro di cucine, industrie alimentari, ospedali, supermercati, ecc..)	Malte epossidiche (classe RG).

### 5A. ELIMINAZIONE DELLO STUCCO IN ECCESSO

Per una corretta ed agevole eliminazione degli eccessi di stucco, si raccomanda di seguire le indicazioni del produttore dello stucco. In generale, si consiglia di attenersi a quanto segue.

#### Stucchi cementizi

Quando lo stucco diventa opaco (normalmente dopo 10-20 minuti), pulire con una spugna di cellulosa dura con movimenti diagonali rispetto alle fughe. E' importante il rispetto di questi tempi per non rischiare di rimuovere lo stucco dalle fughe.

#### Stucchi epossidici

A impasto ancora fresco, bagnare abbondantemente la superficie emulsionando con un tampone tipo Scotch-Brite®, facendo attenzione a non svuotare le fughe. Il residuo liquido di stucco può essere rimosso con una spugna di cellulosa dura (da sostituire se troppo impregnata di resina). E' fondamentale rimuovere lo stucco epossidico tempestivamente prima che inizi ad indurirsi, in quanto la successiva rimozione risulterebbe estremamente difficile. Nel caso in cui lo stucco epossidico abbia già iniziato a indurirsi, provare ad aggiungere all'acqua di lavaggio il 10% di alcool.

### 6 PULIZIA E MANUTENZIONE

#### 6A. PULIZIA DI FINE CANTIERE

Il cantiere è da considerarsi finito quando è sgombro da qualunque utensile/materiale derivante dalle lavorazioni. Per ridurre i rischi di danneggiamento della superficie piastrellata è necessario proteggerla ed evitare la presenza di materiali abrasivi.

Dopo alcuni giorni, eliminare i residui di cantiere con spugna commerciale tipo Scotch-Brite® oppure con spazzolone o monospazzola (per grandi superfici).

Per i rivestimenti, utilizzare un detergente neutro diluito in acqua calda.

Per i pavimenti, utilizzare un detergente acido ad azione tamponata, in percentuale di diluizione variabile in funzione del tipo di superficie (liscia oppure strutturata).

E' importante proteggere preventivamente eventuali inserti in marmo o metallo con nastro adesivo.

Risciacquare poi abbondantemente con acqua calda pulita, sino alla eliminazione di qualsiasi alonatura o residuo negli interstizi.

Se necessario, ripetere il lavaggio acido a concentrazioni più elevate ad eccezione del caso in cui siano presenti inserti in marmo o metallo. Evitare l'utilizzo di acidi da ferramenta diluiti.

#### 6B. MANUTENZIONE ORDINARIA

Si consiglia l'utilizzo di un comune detergente neutro diluito in acqua.

Evitare l'utilizzo di prodotti acidi, alcalini, ceranti e/o impregnanti e pagliette di metallo (spugnette di ferro e acciaio). In caso di sporchi più intensi o di superfici particolarmente strutturate, usare un detergente a base alcalina risciacquando al termine del lavaggio.

Per le grandi superfici è consigliabile l'utilizzo di macchine lavasciuga.

#### 6C. MANUTENZIONE STRAORDINARIA

Nel caso di tracce di sporco resistenti alla pulizia ordinaria, si raccomanda l'utilizzo di un detergente adeguato in funzione del tipo di sporco:

TIPO DI SPORCO (resistente alla manutenzione ordinaria)	DETERGENTE/SOLVENTE
Carbone, efflorescenze calcaree, gesso, segni metallici, ruggine, grafite, tempere murali	Detergenti a base acida *
Coca cola, caffè, vino, birra, gelato	Detergenti a base alcalina
Resine, oli silicnici o meccanici, cere di candela, vernice	Solventi
Pneumatici, suole di gomma, alonature di ventose	Detergenti basici in pasta abrasiva

\* Attenzione: i prodotti a base acida possono corrodere marmo, granito, pietre naturali e metalli, pertanto evitarne l'uso nel caso di decori o inserti realizzati con questi materiali.

Le caratteristiche di pulibilità dei materiali variano in modo significativo per le diverse modalità d'installazione, condizioni d'uso, tipologie di superfici e ambiente. In linea generale, all'aumentare delle caratteristiche di anticivolosità delle piastrelle aumentano le difficoltà di pulizia.

L'operatore professionale incaricato dell'intervento di manutenzione e pulizia dovrà sempre procedere ad una preliminare verifica empirica (possibilmente su una porzione di materiale non posato) per ogni singolo tipo di intervento.

In caso di condizioni d'uso particolarmente gravose (ad esempio, officine meccaniche o ambienti con forte presenza di residui oleosi e tracce di pneumatico), di errata installazione o di pulizie effettuate in modo inadeguato, Atlas Concorde declina ogni responsabilità in merito all'efficacia delle operazioni di pulizia e manutenzione.

Atlas Concorde non potrà essere ritenuta responsabile per eventi, danni o difetti dovuti ad errata installazione, negligente pulizia e manutenzione, o inadeguata scelta della tipologia dei materiali installati e degli adesivi utilizzati con riguardo alla destinazione.

INDEX

A COMPLETE  
PRODUCT  
SYSTEMPRODUCT  
FINDERSURFACE  
RANGE

COMPANY



COLLECTIONS



LARGE SIZES

SLABS FOR  
COUNTERTOPS  
& FURNITURESINKS &  
BATHROOM  
FURNISHING

FACADES

TECHNICAL  
SPECIFICATIONS



## Conseils pour la pose, le nettoyage et l'entretien

### 1. POSE

Avant de commencer la pose, il est recommandé de vérifier que le support est suffisamment sec, plan et propre, et que le matériel fourni soit adapté et suffisant en termes de quantité, teinte et calibre.

### 2. CHOIX DE LA COLLE

Pour la pose, l'utilisation d'une colle appropriée a une importance fondamentale. Il est recommandé de respecter les indications fournies par les meilleurs fabricants de colle pour la pose des carreaux céramiques. Les facteurs ci-après permettent généralement d'identifier la colle la plus adaptée :

- type de support
- typologie et format des carreaux
- destination d'usage du revêtement céramique (sol/mur, intérieur/extérieur)
- conditions climatiques au moment de la pose
- temps disponible pour la mise en service du revêtement céramique

TYPE D'APPLICATION	TYPE DE CARRELAGE	FORMAT:	ADHÉSIFS RECOMMANDÉS Normes Européennes En 12004	
Type de support	Typologie	(cm)	Séchage normal:	Séchage rapide
REVÊTEMENTS DE SOL INTÉRIEURS				
Chapes à base de ciment		< 30x30 cm	Mortiers-collés améliorés, à temps ouvert allongé (classe C2E).	Mortiers-collés améliorés résistant au glissement et déformables (classe C2FT - S1). ●
Revêtements de sol en ciment déjà existants (damés, bou-chardés)		≥ 30x30 cm	Mortiers-collés améliorés résistant au glissement, à temps ouvert allongé (classe C2TE).	Mortiers-collés améliorés résistant au glissement et déformables (classe C2FT - S1). ●
Chapes anhydrite (Après application d'un primaire approprié)	grès cérame	< 60x60 cm		
Chapes chauffantes				
Revêtements de sol déjà existants (Céramique, carreaux de marbre et pierres naturelles)		≥ 60x60 cm	Mortiers-collés améliorés, à temps ouvert allongé et déformables (classe C2E - S1).	Mortiers-collés améliorés résistant au glissement et déformables (classe C2FT - S1). ●
Imperméabilisation salles de bains				
REVÊTEMENTS DE MUR INTÉRIEURS				
Enduit à base de ciment ou mortier	carreaux à pâte blanche	tous formats	Mortiers-collés améliorés résistant au glissement, à temps ouvert allongé (classe C2TE).	Mortiers-collés améliorés résistant au glissement et déformables (classe C2FT - S1). ●
Plâtre (enduits ou panneaux, après application d'un primaire approprié)		< 30x30 cm	Mortiers-collés améliorés résistant au glissement, à temps ouvert allongé (classe C2TE).	Mortiers-collés améliorés résistant au glissement et déformables (classe C2FT - S1). ●
Béton coulé				
Plâtre cartonné (Après avoir appliqué de l'amorçant sur les joints base plâtre)	grès cérame	≥ 30x30 cm	Mortiers-collés améliorés résistant au glissement, à temps ouvert allongé (classe C2TE).	Mortiers-collés améliorés résistant au glissement et déformables (classe C2FT - S1). ●
Imperméabilisation salles de bains et douches		< 60x60 cm	Mortiers-collés améliorés résistant au glissement, à temps ouvert allongé et déformables (classe C2TE - S1).	Mortiers-collés améliorés résistant au glissement et déformables (classe C2FT - S1). ●
Carrelages céramiques déjà existants		≥ 60x60 cm		
REVÊTEMENTS DE SOL EXTÉRIEURS				
		< 30x30 cm	Mortiers-collés améliorés résistant au glissement, à temps ouvert allongé (classe C2TE).	Mortiers-collés améliorés résistant au glissement et déformables (classe C2FT - S1). ●
Chapes à base de ciment	grès cérame	≤ 30x30 cm	Mortiers-collés améliorés résistant au glissement, à temps ouvert allongé et déformables (classe C2TE - S1).	Mortiers-collés améliorés résistant au glissement et déformables (classe C2FT - S1). ●
Dallage en béton		< 60x60 cm		
Couches d'imperméabilisation		≥ 60x60 cm	Mortiers-collés améliorés, à temps ouvert allongé et hautement déformables (classe C2E - S2).	Mortiers-collés améliorés, à temps ouvert allongé et hautement déformables (classe C2E - S2). ●
REVÊTEMENTS DE MUR EXTÉRIEURS				
		< 30x30 cm	Mortiers-collés améliorés résistant au glissement, à temps ouvert allongé et déformables (classe C2TE - S1).	Mortiers-collés améliorés résistant au glissement et déformables (classe C2FT - S1). ●
		≥ 30x30 cm	Mortiers-collés améliorés résistant au glissement, à temps ouvert allongé et déformables (classe C2TE - S1).	Mortiers-collés améliorés résistant au glissement et déformables (classe C2FT - S1). ●
	carreaux en grès cérame	< 60x60 cm ●●		
		≥ 60x60 cm ●●	Mortiers-collés améliorés, à temps ouvert allongé et hautement déformables (classe C2E - S2).	Mortiers-collés améliorés et hautement déformables (classe C2F - S2). ●

- En cas de pose à basse température ou bien de mise en service rapide du revêtement céramique, il est préférable d'utiliser des mortiers-collés améliorés à prise rapide (Classe C2F – EN 12004).
- En cas de carreaux de côté dépassant 30 cm appliqués à des hauteurs de plus de 3 mètres, certaines normes internationales exigent l'utilisation d'un ancrage mécanique supplémentaire, pour assurer la rétention du carreau en cas de décollage accidentel. Ceux-ci doivent être choisis en fonction du poids du carreau, de la hauteur du revêtement et des conditions sur le chantier.

### 3. POSE DES CARREAUX

La pose doit être effectuée par du personnel qualifié et à l'aide d'outils adéquats. Il est opportun de vérifier la pose du matériel avant le séchage de la colle de sorte à pouvoir effectuer toute éventuelle correction le cas échéant. Atlas Concorde déconseille, dans tous les cas, d'effectuer la pose à bords unis ou une pose avec des joints inférieurs à 2 mm. En cas de pose de carreaux ayant un côté d'une longueur supérieure à 60 cm, ou de pose à l'intérieur d'espaces commerciaux ou en extérieur, il est fondamental d'étaler la colle avec le système du double encollage, à savoir en appliquant la colle de manière linéaire et parallèle au côté court, tant sur le support de pose qu'au dos du carreau, en garantissant ainsi la parfaite adhérence de l'interface carreau-support. Pour minimiser tout éventuel écart de planéité durant la pose, que ce soit sur le sol ou sur le mur, il est recommandé d'adopter des "systèmes de pose facilitée" en utilisant des croisillons et des niveleurs qui peuvent être munis de supports anti-ébréchures et anti-rayures en cas de pose de carreaux en pâte blanche émaillés et/ou de carreaux en grès en finition semi-polie. Dans le cas particulier des carreaux tridimensionnels, il est conseillé d'utiliser des systèmes de nivellement à vis, en alternative aux systèmes à coin.

### 3A. POSE DE FORMATS RECTANGULAIRES

En cas de pose droite décalée de formats rectangulaires, le décalage maximum entre les carreaux ne doit pas dépasser 1/3 de la longueur du côté adjacent.

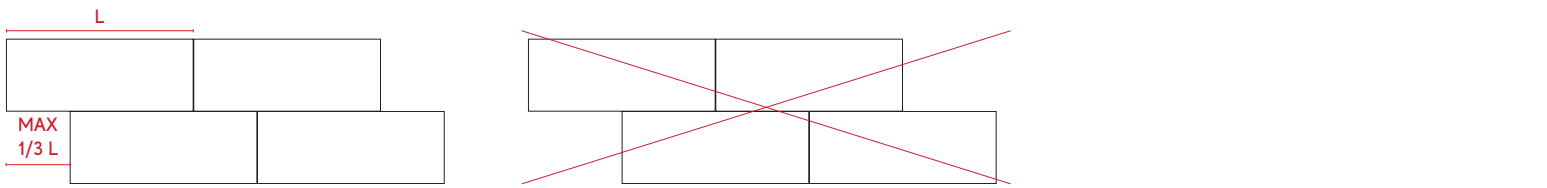

### 4. EXÉCUTION DE DÉCOUPES À ANGLE DROIT OU BISEAUTÉES

Pour effectuer des coupes carrées ou biseautées, il est conseillé de commencer par effectuer des trous circulaires en proximité des bords de la découpe, puis, dans un deuxième temps, de les relier par des coupes linéaires, ce qui permettra d'obtenir une relaxation des contraintes au niveau des bords du carreau découpé.

### 5. JOINT ET STUCAGE

Avant de procéder au stucage des joints, il est conseillé d'attendre le séchage complet de la colle et de vérifier que les joints de pose soient privés de toute trace de colle et/ou de poussières. Atlas Concorde déconseille, dans tous les cas, d'effectuer la pose à bords unis ou de la réaliser avec des joints inférieurs à 2 mm. Pour des joints en contraste chromatique avec les carreaux, il est conseillé de tester le joint dans une petite zone cachée du carrelage. Il est recommandé de respecter les indications des meilleurs fabricants de mortiers de jointoiment.

TYPE D'APPLICATION	MORTIERS RECOMMANDÉS - Norme Européenne En 13888
Espaces résidentiels intérieurs	Mortiers à base de ciment pour joints améliorés (Classe CG2)
Espaces humides intérieurs (salles de bains, douches) et espaces extérieurs	Mortiers à base de ciment pour joints améliorés à faible absorption d'eau (Classe CG2 WA)
Espaces à usage commercial	Mortiers à base de ciment pour joints améliorés, hautement résistants à l'abrasion (Classe CG2 A)
Espaces nécessitant une hygiène totale et une résistance aux agents chimiques (piscines, plans de travail de cuisines, industries alimentaires, hôpitaux, supermarchés, etc.)	Mortiers époxy (Classe RG).

### 5A. ÉLIMINATION DU MORTIER-JOINT EXCÉDENTAIRE

Pour éliminer correctement et facilement le produit excédentaire, il est recommandé de suivre les indications du fabricant du mortier de jointoiment. En général, il est conseillé de respecter les indications suivantes.

#### Mortiers-joints à base de ciment

Lorsque le mortier devient opaque (généralement au bout de 10-20 minutes), nettoyer à l'aide d'une éponge en cellulose dure en faisant des mouvements en diagonale par rapport aux joints. Il est important de respecter le temps indiqué pour ne pas risquer de retirer le mortier des joints.

#### Mortiers-joints époxy

Lorsque le mélange est encore frais, mouiller abondamment la surface et émulsionner avec une éponge de type Scotch-Brite® en veillant à ne pas vider les joints. Le résidu liquide du mortier peut être éliminé à l'aide d'une éponge en cellulose dure (à remplacer si elle est trop imprégnée de résine). Il est fondamental d'éliminer le mortier à temps, avant qu'il ne com-mence à durcir, après quoi l'opération s'avère extrêmement difficile. Si le mortier époxy a déjà commencé à prendre, essayer d'ajouter 10% d'alcool à l'eau de lavage.

### 6 NETTOYAGE ET ENTRETIEN

### 6A. NETTOYAGE EN FIN DE CHANTIER

Le chantier est considéré terminé lorsque tous les outils et le matériel dérivant des travaux ont été retirés du carrelage. Pour réduire tout risque de dommage sur la surface carrelée, il est nécessaire de la protéger et d'éviter toute présence de matériaux abrasifs. Après quelques jours, éliminer les résidus de chantier à l'aide d'une éponge commerciale de type Scotch-Brite® ou avec un balai-brosse ou un balai d'atelier (pour grandes superficies). Pour le carrelage mural, utiliser un produit détergent neutre dilué dans de l'eau chaude. Pour le carrelage au sol, utiliser un produit détergent acide à effet tampon en variant le pourcentage de dilution selon le type de surface (lisse ou structurée). Il est important de protéger préalablement les éventuels inserts en marbre ou en métal avec du ruban adhésif. Puis rincer abondamment avec de l'eau chaude propre jusqu'à ce qu'il n'y ait plus d'auroles ni de résidus dans les interstices. Si nécessaire, répéter le lavage acide à des concentrations plus élevées, sauf en présence d'inserts en marbre ou en métal. Éviter toute utilisation d'acides commerciaux dilués.

### 6B. ENTRETIEN ORDINAIRE

Il est conseillé d'utiliser un produit détergent neutre ordinaire, dilué dans l'eau.

Éviter toute utilisation de produits acides, alcalins, à base de cires et/ou d'agents d'imprégnation, ainsi que les pailles de fer (éponges métalliques en fer et en acier). En cas de saleté plus consistante ou de surfaces particulièrement structurées, utiliser un produit détergent à base alcaline et rincer en fin de lavage.

Pour de grandes superficies, il est recommandé d'utiliser des appareils laveurs et sécheurs.

### 6C. ENTRETIEN EXTRAORDINAIRE

En cas de salissures résistant à l'entretien ordinaire, il est recommandé d'utiliser un produit nettoyant approprié au type de tache :

TYPE DE SALETÉ (résistant à l'entretien ordinaire)	DÉTÉRGENT/SOLVANT
Charbon, efflorescences calcaires, plâtre, signes métalliques, rouille, graphite, peintures murales à la détrempe	Détergents à base acide *
Coca-cola, café, vin, bière, glace	Détergents à base alcaline
Résines, huiles silicones ou mécaniques, cire de bougie, peinture	Solvants
Pneus, semelles en caoutchouc, auroles provoquées par des ventouses	Détergents basiques en pâte abrasive

\* Attention : les produits à base d'acide peuvent ronger le marbre, le granit, les pierres naturelles et les métaux, par conséquent ne pas les utiliser en présence de décors ou d'inserts réalisés avec ces types de matériaux.

Les caractéristiques de nettoyabilité des matériaux peuvent varier de façon significative selon les modalités de pose, les conditions d'utilisation, les types de surface et de lieux. En général, plus les caractéristiques antidérapantes des carreaux sont élevées, plus le nettoyage est difficile. Avant chaque intervention, l'opérateur professionnel chargé de l'entretien et du nettoyage devra toujours effectuer un contrôle empirique (si possible sur une portion de matériau non posée). Atlas Concorde décline toute responsabilité sur l'efficacité des opérations de nettoyage et d'entretien en cas de conditions d'utilisation particulièrement lourdes (par exemple, ateliers de mécaniciens ou lieux présentant d'importants résidus huileux ou des traces de pneu).

Atlas Concorde ne saurait être tenue responsable d'événements, de dommages ou de défauts dus à une pose erronée, à des nettoyage ou entretien négligés, au mauvais choix de la typologie du matériel posé ou aux colles utilisées pour la destination d'usage considérée.

## INDEX



## A COMPLETE PRODUCT SYSTEM



## PRODUCT FINDER



## SURFACE RANGE



## COMPANY



## COLLECTIONS



## LARGE SIZES



## SLABS FOR COUNTERTOPS & FURNITURE



## SINKS & BATHROOM FURNISHING



## FACADES



## TECHNICAL SPECIFICATIONS



## Empfehlungen für Verlegung, Reinigung und Pflege

### 1. VERLEGUNG

Vor Beginn der Verlegung sicherstellen, dass der Untergrund ausreichend verlegereif, eben und einwandfrei sauber ist, und dass das gelieferte Material und nach Menge, Farbton und Kaliber geeignet und ausreichend ist.

### 2. WAHL DES KLEBERS

Der Gebrauch eines geeigneten Klebers ist für die Verlegung von grundlegender Bedeutung. Befolgen Sie die Angaben der führenden Kleberhersteller für die Verlegung von Keramikfliesen. In der Regel kann der geeignetste Kleber aufgrund der folgenden Faktoren bestimmt werden:

- Art des Untergrunds;
- Fliesentyp und Fliesenformat;
- Gebrauchsbestimmung des Keramikbelags (Boden-/Wandbelag; Innen-/Außenbereich);
- klimatische Bedingungen bei der Verlegung;
- verfügbare Zeiten für die Inbetriebnahme des Belags.

GEBRAUCHSBESTIMMUNG Art des Untergrunds	FLIESENTYP Typ	FORMAT (cm)	EMPFOHLENE KLEBER - Europäische Normen EN 12004	
			Normal Abbindend	Schnell Abbindend
<b>BÖDEN IM INNENBEREICH</b>				
Zementestriche Bestehende Bodenbeläge (gebundene, verdichtete Betonuntergründe) Anhydritestriche (nach entsprechender Behandlung mit Primer) Heizestriche Bestehende Bodenbeläge aus Keramik, Terrazzo, Naturstein Abdichtung in Nassräumen	Feinsteinzeugfliesen	< 30x30 cm	Vergütete Zementkleber mit verlängerter klebeoffener Zeit (Klasse C2E).	Vergütete, standfeste und flexible Zementkleber (Klasse C2FT - S1). ●
		≥ 30x30 cm < 60x60 cm	Vergütete, standfeste, flexible Zementkleber mit verlängerter klebeoffener Zeit gemäß und Verformbarkeit gemäß (Klasse C2TE).	Vergütete, standfeste und flexible Zementkleber (Klasse C2FT - S1). ●
		≥ 60x60 cm	Vergütete, flexible Zementkleber mit verlängerter klebeoffener Zeit gemäß und Verformbarkeit gemäß (Klasse C2E - S1).	Vergütete, standfeste und flexible Zementkleber (Klasse C2FT - S1). ●
<b>WANDBELÄGE IM INNENBEREICH</b>				
Zementputz oder Mörtel Gips (Putze oder Platten, nach entsprechender Behandlung mit Primer) Ortbeton Gipskarton (Auf gipshaltige Fugen vorher Primer auftragen) Abdichtung in Bädern und Duschen Bestehende Keramikfliesen	Weißscherbige Fliesen	Alle Formate	Vergütete, standfeste, flexible Zementkleber mit verlängerter klebeoffener Zeit gemäß und Verformbarkeit gemäß (Klasse C2TE).	Vergütete, standfeste und flexible Zementkleber (Klasse C2FT - S1). ●
		< 30x30 cm	Vergütete, standfeste, flexible Zementkleber mit verlängerter klebeoffener Zeit gemäß und Verformbarkeit gemäß (Klasse C2TE).	Vergütete, standfeste und flexible Zementkleber (Klasse C2FT - S1). ●
		≥ 30x30 cm < 60x60 cm	Vergütete, standfeste, flexible Zementkleber mit verlängerter klebeoffener Zeit gemäß und Verformbarkeit gemäß (Klasse C2TE).	Vergütete, standfeste und flexible Zementkleber (Klasse C2FT - S1). ●
	Feinsteinzeugfliesen	≥ 30x30 cm < 60x60 cm	Vergütete, standfeste, flexible Zementkleber mit verlängerter klebeoffener Zeit gemäß und Verformbarkeit gemäß (Klasse C2TE - S1).	Vergütete, standfeste und flexible Zementkleber (Klasse C2FT - S1). ●
		≥ 60x60 cm	Vergütete, standfeste, flexible Zementkleber mit verlängerter klebeoffener Zeit gemäß und Verformbarkeit gemäß (Klasse C2TE - S1).	Vergütete, standfeste und flexible Zementkleber (Klasse C2FT - S1). ●
		<b>BÖDEN IM AUSSENBEREICH</b>		
Zementestriche Betonuntergrund Abdichtschichten	Feinsteinzeugfliesen	< 30x30 cm	Vergütete, standfeste Zementkleber mit verlängerter klebeoffener Zeit (Klasse C2TE).	Vergütete, standfeste und flexible Zementkleber (Klasse C2FT - S1). ●
		≤ 30x30 cm < 60x60 cm	Vergütete, standfeste, flexible Zementkleber mit verlängerter klebeoffener Zeit gemäß und Verformbarkeit gemäß (Klasse C2TE - S1).	Vergütete, standfeste und flexible Zementkleber (Klasse C2FT - S1). ●
		≥ 60x60 cm	Vergütete, hochflexible Zementkleber mit verlängerter klebeoffener Zeit gemäß und Verformbarkeit gemäß (Klasse C2E - S2).	Vergütete, hochflexible Zementkleber mit verlängerter klebeoffener Zeit gemäß und Verformbarkeit gemäß (Klasse C2FE - S2). ●
<b>AUSSENWANDBELÄGE</b>				
Zementputz Ortbeton und Fertigbeton	Feinsteinzeugfliesen	< 30x30 cm	Vergütete, standfeste, flexible Zementkleber mit verlängerter klebeoffener Zeit gemäß und Verformbarkeit gemäß (Klasse C2TE - S1).	Vergütete, standfeste und flexible Zementkleber (Klasse C2FT - S1). ●
		≥ 30x30 cm < 60x60 cm ●●	Vergütete, standfeste, flexible Zementkleber mit verlängerter klebeoffener Zeit gemäß und Verformbarkeit gemäß (Klasse C2TE - S1).	Vergütete, standfeste und flexible Zementkleber (Klasse C2FT - S1). ●
		≥ 60x60 cm ●●	Vergütete, hochflexible Zementkleber mit verlängerter klebeoffener Zeit gemäß und Verformbarkeit gemäß (Klasse C2E - S2).	Vergütete und hochflexible Zementkleber (Klasse C2F - S2). ●

- Bei der Verlegung bei niedrigen Temperaturen oder falls eine rasche Inbetriebnahme des Belags erforderlich ist, wird der Gebrauch von schnell abbindenden zementären Klebemörteln mit verbesserter Haftung (Klasse C2F - EN 12004) empfohlen.
- Für Fliesen mit langer Seite über 30 cm, die in einer Höhe von über 3 Metern verlegt werden, schreiben einige internationale Vorschriften eine zusätzliche mechanische Verankerung vor, die die Fliese bei unbeabsichtigter Ablösung zurückhält und je nach Fliesengewicht, Belagshöhe und Baustellenbedingungen gewählt werden müssen.

### 3. VERLEGEN DER FLIESEN

Die Verlegung muss durch Fachpersonal und mit geeigneten Arbeitsgeräten durchgeführt werden. Die Verlegung ist zu überprüfen, bevor der Kleber ausgehärtet ist, um noch eventuelle Korrekturen vornehmen zu können. Atlas Concorde rät in jedem Fall von der fugenlosen Verlegung bzw. von einer Fugenbreite unter 2 mm ab. Bei Fliesen mit einer Seite von mehr als 60 cm Länge und in jedem Fall in gewerblich genutzten Innenräumen sowie bei der Verlegung im Freien ist der Kleber unbedingt mit dem Buttering-Floating-Verfahren aufzutragen, wobei er linear parallel zur kurzen Seite aufzuziehen ist, und zwar sowohl auf dem Verlegeuntergrund als auch auf der Fliesenrückseite, damit ein perfektes Anhaften der Verbindung zwischen Keramikfliese und Untergrund gewährleistet ist. Zur Reduzierung von Unebenheiten in der Verlegung an Wand und Boden empfiehlt es sich, Verlegehilfen wie Distanzstücke und Nivellierelemente zu verwenden. Diese können bei Verlegung glasierter Wandfliesen aus Weißscherben und/oder Feinsteinzeug mit geläppter Oberfläche eine Unterlage zum Schutz gegen Abspalten der Kanten und Verkratzung aufweisen. Bei besonderen, dreidimensionalen Wandbelägen empfiehlt es sich, zur Nivellierung anstelle von Keilen Schraubsysteme zu verwenden.

### 3A. VERLEGUNG RECHTECKIGER FORMATE

Bei fortlaufender Längsverlegung rechteckiger Formate dürfen die Fliesen nicht um mehr als 1/3 der Länge der jeweils angrenzenden Seiten versetzt werden.

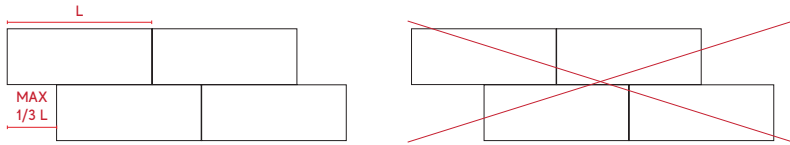

### 4. AUSFÜHRUNG QUADRATISCHER BZW. LOTRECHTER SCHNITTE

Für quadratische oder lotrechte Schnitte empfiehlt es sich, zunächst an den Eckpunkten des Schnitts kreisförmige Bohrungen auszuführen und diese anschließend durch lineare Schnitte zu verbinden. Auf diese Weise werden die Spannungen an den Ecken der geschnittenen Fliese abgebaut.

### 5. FUGEN UND VERFUGUNG

Vor dem Füllen der Fugen sollte das vollständige Austrocknen des Klebers abgewartet werden; zudem ist sicherzustellen, dass die Fugen keinerlei Spuren von Kleber und/oder Pulver bzw. Staub aufweisen. Atlas Concorde rät in jedem Fall von der fugenlosen Verlegung bzw. von einer Fugenbreite unter 2 mm ab. Für farblich mit den Fliesen kontrastierende Fugen sollte die Fugenmasse auf einem kleinen, nicht sichtbaren Bereich der gefliesten Fläche getestet werden. Befolgen Sie die Angaben der führenden Fugenmassenhersteller.

GEBRAUCHSBESTIMMUNG	EMPFOHLENE FUGENMASSEN - EUROPÄISCHE NORM EN 13888
Innenbereich in privaten Objekten	Vergütete Fugenmörtel (Klasse CG2)
Nassräume im Innenbereich (Badezimmer, Duschen) und im Außenbereich	Zementäre Fugenmörtel mit verbesserten Eigenschaften und reduzierter Wasseraufnahme (Klasse CG2 WA)
Innenbereich in gewerblichen Objekten	Zementäre Fugenmörtel mit verbesserten Eigenschaften und hoher Abriebfestigkeit (Klasse CG2 A)
Bereiche, in denen es auf absolute Hygiene und Chemikalienbeständigkeit ankommt (Schwimmbekken, Arbeitsplatten in Küchen, Lebensmittelindustrie, Krankenhäuser, Supermärkte etc.).	Epoxidharzfugenmörtel (Klasse RG).

### 5A. ENTFERNEN DER ÜBERSCHÜSSIGEN FUGENMASSE

Für die korrekte und problemlose Entfernung von überschüssiger Fugenmasse die Angaben des Herstellers befolgen. Generell wird empfohlen, folgende Anweisungen zu beachten.

#### Zementäre Fugenmörtel

Wenn die Fugenmasse nicht mehr glänzt (normalerweise nach 10-20 Minuten), mit einem harten Zelluloseschwamm diagonal zum Fugenverlauf reinigen. Diese Zeiten müssen beachtet werden, um ein Entfernen der Fugenmasse aus den Fugen zu vermeiden.

#### Epoxidharz-Fugenmörtel

Bei noch frischer Masse die Oberfläche mit viel Wasser anässen und mit einem Pad vom Typ Scotch-Brite® bearbeiten; darauf achten, dass die Fugen nicht ausgewaschen werden. Die flüssigen Fugenmassenreste mit einem harten Zelluloseschwamm (zu ersetzen, falls zu sehr mit Harz imprägniert) entfernen. Wichtig ist es, dass die Epoxidharz-Fugenmasse rechtzeitig entfernt wird, bevor sie auszuhärten beginnt, da sie danach nur sehr schwer beseitigt werden kann. Falls die Epoxidharz-Fugenmasse bereits begonnen hat auszuhärten, kann man versuchen, dem Waschwasser 10 % Alkohol beizumengen.

### 6 REINIGUNG UND PFLEGE

#### 6A. BAUSCHLUSSREINIGUNG

Die Baustelle ist als abgeschlossen zu betrachten, wenn keinerlei Werkzeuge/Bearbeitungsrückstände mehr vorhanden sind. Um die Gefahr einer Beschädigung der gefliesten Fläche zu verringern, ist diese abzudecken, und der Kontakt mit abrasiven Materialien ist zu vermeiden. Nach einigen Tagen die Rückstände mit Scotch-Pad® oder mit einer Bürste bzw. einer Einscheiben-Bodenreinigungsmaschine (bei großen Flächen) entfernen. Für die Wandbeläge einen mit warmem Wasser verdünnten neutralen Reiniger verwenden. Für die Bodenbeläge ein saures Reinigungsmittel mit Pufferwirkung verwenden, das je nach Oberfläche (glatt oder strukturiert) zu verdünnen ist. Wichtig ist es, dass eventuelle Marmor- oder Metalleinleger vorsorglich mit Klebeband geschützt werden. Danach mit reichlich warmem und sauberem Wasser nachspülen, bis Schleier und Schmutz restlos entfernt sind. Gegebenenfalls die Reinigung mit einer stärker konzentrierten Säurelösung wiederholen; bei Marmor- oder Metalleinlegern ist dies jedoch zu vermeiden. Keine verdünnten Säuren für Eisenwaren verwenden.

#### 6B. NORMALE PFLEGE

Für die Pflege wird ein gewöhnlicher, mit Wasser verdünnter neutraler Reiniger empfohlen.

Saure oder alkalische Produkte, Wachs- und/oder Imprägniermittel sowie Stahlwollepads (Eisen- und Stahlschwämme) sind zu vermeiden. Bei hartnäckiger Verschmutzung oder besonders strukturierten Oberflächen einen alkalischen Reiniger verwenden und nach dem Reinigen nachspülen. Bei großen Flächen empfiehlt sich die Verwendung einer Bodenreinigungsmaschine.

#### 6C. SONDERREINIGUNG

Bei durch normale Pflege nicht zu beseitigender Verschmutzung wird der Gebrauch eines für die jeweilige Schmutzart geeigneten Reinigers empfohlen.

SCHMUTZART (hartnäckig gegen normale Pflegeprodukte)	REINIGER/LÖSEMITTEL
Kohle, Kalkausblühungen, Gips, Metallabrieb, Rost, Graphit, Wandanstriche	Saure Reiniger*
Coca-Cola, Kaffee, Wein, Bier, Speiseeis	Alkalische Reiniger
Kunstharz, Silikon und mechanisches Öl, Kerzenwachs, Lack	Lösemittel
Gummiabrieb (Reifen, Schuhsohlen, Abdrücke von Saugnäpfen)	Basische Reiniger (Scheuerpaste)

\* Achtung: Produkte auf Säurebasis können Marmor, Granit, Naturstein und Metalle angreifen. Bei Einlegern oder Dekorfliesen aus diesen Materialien sind sie deshalb zu vermeiden

Die Eigenschaften hinsichtlich der Reinigbarkeit der Materialien variieren erheblich je nach Verlegungsart, Einsatzbedingungen, Oberfläche und Umgebung. In der Regel sind Bodenbeläge mit zunehmender Rutschhemmung schwerer zu reinigen. Die mit der Pflege und Reinigung beauftragte Fachkraft muss für einen jeden Eingriff immer eine empirische Vorabkontrolle vornehmen (möglichst auf nicht verlegtem Material). Bei besonders schwierigen Einsatzbedingungen (z.B. in Werkstätten oder bei Vorliegen von stark öliger Verschmutzung und Reifenspuren), falscher Verlegung oder unsachgemäß ausgeführter Reinigung übernimmt Atlas Concorde keine Haftung für die Wirksamkeit der Reinigungs- und Pflegearbeiten. In keinem Fall ist Atlas Concorde für Ereignisse, Schäden oder Mängel verantwortlich, die auf eine falsche Verlegung, nachlässige Reinigung und Pflege oder auf eine ungeeignete Auswahl der verlegten Materialien und verwendeten Kleber für die jeweilige Gebrauchsbestimmung zurückzuführen sind.

INDEX

A COMPLETE  
PRODUCT  
SYSTEMPRODUCT  
FINDERSURFACE  
RANGE

COMPANY



COLLECTIONS



LARGE SIZES

SLABS FOR  
COUNTERTOPS  
& FURNITURESINKS &  
BATHROOM  
FURNISHING

FACADES

TECHNICAL  
SPECIFICATIONS

## Sugerencias para la colocación / sugerencias para la limpieza y el mantenimiento

### 1. OPERACIÓN DE COLOCACIÓN

Antes de empezar la operación de colocación, se aconseja asegurarse de que la superficie de apoyo esté suficientemente seca, plana y bien limpia, y que el material suministrado sea adecuado y suficiente en términos de su cantidad, tono y calibre.

### 2.ELECCIÓN DEL ADHESIVO

El empleo de un adhesivo adecuado tiene suma importancia para la colocación. Se aconseja atenerse a las indicaciones de los mejores productores de adhesivos para la colocación de baldosas cerámicas. Por lo general, el adhesivo más adecuado se identifica considerando los siguientes factores:

- tipo de soporte;
- tipología y formato de las baldosas;
- destino de uso (pavimento/revestimiento; interiores/exteriores) del revestimiento cerámico;
- condiciones climáticas en el momento de la colocación;
- tiempos a disposición para la puesta en uso del revestimiento cerámico

DESTINO DE USO Tipo de soporte	TIPO DE BALDOSAS Tipología	FORMATO (cm)	ADHESIVOS RECOMENDADOS - Normativa Europea EN 12004	
			Toma normal	Toma rápida
<b>PAVIMENTOS INTERNOS</b>				
Morteros cementosos Pavimentos de cemento existentes (batido, bujardado) Bloques delgados de anhidrita (previa aplicación de un producto adecuado de imprimación) Morteros cementosos calefactores Pavimentos de cerámica, baldosas y piedras naturales existentes Impermeabilización en baños	gres porcelánico	< 30x30 cm	Adhesivos cementosos, mejorados con tiempo abierto prolongado (Clase C2E).	Adhesivos cementosos mejorados, resistentes al deslizamiento y deformables (Clase C2FT - S1). ●
		≥ 30x30 cm < 60x60 cm	Adhesivos cementosos mejorados, resistentes al deslizamiento con tiempo abierto prolongado (Clase C2TE).	Adhesivos cementosos mejorados, resistentes al deslizamiento y deformables (Clase C2FT - S1). ●
		≥ 60x60 cm	Adhesivos cementosos mejorados, con tiempo abierto prolongado y deformables (Clase C2E - S1).	Adhesivos cementosos mejorados, resistentes al deslizamiento y deformables (Clase C2FT - S1). ●
<b>REVESTIMIENTOS INTERNOS</b>				
Revoque de cemento o mortero, yeso (revoques o paneles, previa aplicación de un producto adecuado de Imprimación) Colada de hormigón Yeso encartonado (Prevía aplicación de imprimación en las juntas a base de yeso) Impermeabilizaciones en baños y duchas Baldosas cerámica existentes	revestimientos de pasta blanca     gres porcelánico	Cualquier formato	Adhesivos cementosos mejorados, resistentes al deslizamiento con tiempo abierto prolongado (Clase C2TE).	Adhesivos cementosos mejorados, resistentes al deslizamiento y deformables (Clase C2FT - S1). ●
		< 30x30 cm	Adhesivos cementosos mejorados, resistentes al deslizamiento con tiempo abierto prolongado (Clase C2TE).	Adhesivos cementosos mejorados, resistentes al deslizamiento y deformables (Clase C2FT - S1). ●
		≥ 30x30 cm < 60x60 cm	Adhesivos cementosos mejorados, resistentes al deslizamiento con tiempo abierto prolongado (Clase C2TE).	Adhesivos cementosos mejorados, resistentes al deslizamiento y deformables (Clase C2FT - S1). ●
Cualquier formato	gres porcelánico	≥ 60x60 cm	Adhesivos cementosos mejorados, resistentes al deslizamiento con tiempo abierto prolongado y deformables (Clase C2TE - S1).	Adhesivos cementosos mejorados, resistentes al deslizamiento y deformables (Clase C2FT - S1). ●
		< 30x30 cm	Adhesivos cementosos mejorados, resistentes al deslizamiento con tiempo abierto prolongado (Clase C2TE).	Adhesivos cementosos mejorados, resistentes al deslizamiento y deformables (Clase C2FT - S1). ●
		≤ 30x30 cm < 60x60 cm	Adhesivos cementosos mejorados, resistentes al deslizamiento con tiempo abierto prolongado y deformables (Clase C2TE - S1).	Adhesivos cementosos mejorados, resistentes al deslizamiento y deformables (Clase C2FT - S1). ●
Morteros cementosos Soleras de hormigón Capas de impermeabilización	gres porcelánico	≥ 60x60 cm	Adhesivos cementosos mejorados, con tiempo abierto prolongado y altamente deformables (Clase C2E - S2).	Adhesivos cementosos mejorados, con tiempo abierto prolongado y altamente deformables (Clase C2FE - S2). ●
		< 30x30 cm	s cementosos mejorados, resistentes al deslizamiento con tiempo abierto prolongado y deformables (Clase C2TE - S1).	Adhesivos cementosos mejorados, resistentes al deslizamiento y deformables (Clase C2FT - S1). ●
		≤ 30x30 cm < 60x60 cm	Adhesivos cementosos mejorados, resistentes al deslizamiento con tiempo abierto prolongado y deformables (Clase C2TE - S1).	Adhesivos cementosos mejorados, resistentes al deslizamiento y deformables (Clase C2FT - S1). ●
<b>REVESTIMIENTOS EXTERNOS</b>				
Revoque de cemento Colada de hormigón u hormigón prefabricado	gres porcelánico	≥ 60x60 cm ●●	Adhesivos cementosos mejorados, con tiempo abierto prolongado y altamente deformables (Clase C2E - S2).	Adhesivos cementosos mejorados y altamente deformables (Clase C2F - S2). ●
		< 30x30 cm	s cementosos mejorados, resistentes al deslizamiento con tiempo abierto prolongado y deformables (Clase C2TE - S1).	Adhesivos cementosos mejorados, resistentes al deslizamiento y deformables (Clase C2FT - S1). ●
		≥ 30x30 cm < 60x60 cm ●●	Adhesivos cementosos mejorados, resistentes al deslizamiento con tiempo abierto prolongado y deformables (Clase C2TE - S1).	Adhesivos cementosos mejorados, resistentes al deslizamiento y deformables (Clase C2FT - S1). ●

- En caso de colocación en condiciones de bajas temperaturas o bien si fuera necesario poner en uso rápidamente el revestimiento cerámico, es preferible el empleo de adhesivos cementosos mejorados de fraguado rápido (Clase C2F - EN 12004).
- Para baldosas con lado mayor a 30 cm colocadas a una altura superior a 3 metros, algunas normativas internacionales prevén el empleo de una fijación mecánica suplementaria que asegure la retención de la baldosa en caso de desprendimiento accidental, a elegir según el peso de la baldosa, la altura del revestimiento y las condiciones de la obra.

### 3. COLOCACIÓN DE LAS BADOSAS

La colocación debe estar a cargo de personal cualificado y con herramientas adecuadas. Se aconseja comprobar la colocación del material antes de que el adhesivo se haya secado para poder realizar cualquier corrección necesaria. En todo caso, Atlas Concorde recomienda no colocar las baldosas "a tope" o con juntas menores de 2 mm.

En caso de colocación de baldosas con un lado cuyo largo supere los 60cm, y en cualquier caso para ambientes interiores comerciales o bien en el exterior, es fundamental aplicar el adhesivo con el sistema de doble esparcimiento, aplicando la cola de modo lineal en dirección paralela al lado corto, tanto en el soporte de colocación como en el revés de la baldosa, garantizando la perfecta adherencia al interfaz baldosa cerámica y el soporte. Para minimizar los desniveles del sistema de colocación en pavimentos o revestimientos, se recomienda adoptar "sistemas de colocación facilitada" con distanciadores y niveladores que pueden tener alfombrillas de protección contra abolladuras o arañazos cuando se colocan revestimientos de esmalte de pasta blanca y/o gres con acabado pulido. En el caso particular de los revestimientos tridimensionales, recomendamos el uso de sistemas de nivelación por tornillo como alternativa a los sistemas de nivelación por cuña.

### 3A. COLOCACIÓN DE FORMATOS RECTANGULARES

En el caso de la colocación "a matajunta" de formatos rectangulares, el desfase máximo entre baldosas no debe superar 1/3 de la longitud del lado adyacente.

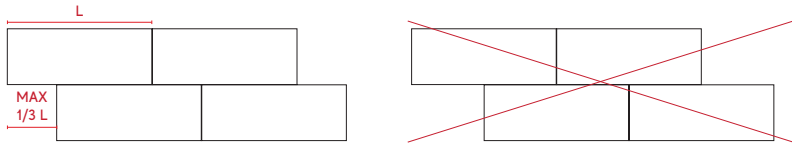

### 4. EJECUCIÓN DE CORTES CUADRADOS O ESCUADRADOS

Para ejecutar cortes cuadrados o escuadrados, se aconseja realizar inicialmente agujeros circulares cerca de los vértices del corte y conectarlos posteriormente mediante cortes lineales, de esta manera se relajarán las tensiones en los vértices de la baldosa cortada.

### 5. JUNTA Y ESTUCADO

Antes de rellenar las juntas se recomienda esperar a que el adhesivo se haya secado completamente y asegurarse de que las juntas no tengan ningún rastro de adhesivo y/o polvo. En todo caso, Atlas Concorde recomienda no colocar las baldosas "a tope" o con juntas menores de 2 mm. Para las juntas en contraste cromático con las baldosas, es aconsejable probar el estucado en una zona circunscrita y oculta de la colocación. Se recomienda atenerse a las indicaciones de los mejores productores de estucos para juntas.

DESTINO DE USO	ESTUCOS RECOMENDADOS - NORMATIVA EUROPEA EN 13888
Ambientes internos residenciales	Morteros cementosos para juntas mejoradas (Clase CG2)
Ambientes húmedos internos (baños, duchas) y ambientes externos	Morteros cementosos para juntas mejoradas con una reducida absorción de agua (Clase CG2 WA)
Ambientes de uso comercial	Morteros cementosos para juntas mejoradas con una elevada resistencia a la abrasión (Clase CG2 A)
Ambientes en los cuales se requiera una higiene total y resistencia a los agentes químicos (piscinas, encimeras de cocinas, industrias alimenticias, hospitales, supermercados, etc..)	Morteros epoxídicos (Clase RG).

### 5A. ELIMINACIÓN DEL ESTUCO EN EXCESO

Para una eliminación correcta y sencilla de los residuos de estuco, se recomienda seguir las indicaciones del productor del mismo. Por lo general, se recomienda atenerse a las siguientes recomendaciones.

#### Estucos de cemento

Cuando el estuco se vuelve opaco (normalmente al cabo de 10-20 minutos), limpiar con una esponja de celulosa dura con movimientos diagonales respecto a las juntas. Es importante respetar estos tiempos para no correr el riesgo de quitar el estuco de las juntas.

#### Estucos epoxídicos

Con la pasta aún fresca, mojar bien la superficie emulsionando con un estropajo Scotch-Brite®, prestando atención para no vaciar las juntas. El residuo líquido de estuco puede eliminarse con una esponja de celulosa dura (que habrá que cambiar si está demasiado empapada de resina). Es importante eliminar el estuco epoxídico rápidamente antes de que empiece a fraguar, porque quitarlo más tarde resultaría muy difícil. Si el estuco epoxídico ya ha empezado a fraguar, añadir al agua de lavado el 10% de alcohol.

### 6. LIMPIEZA Y MANTENIMIENTO

#### 6A. LIMPIEZA FINAL DE LA OBRA

La obra se considera terminada cuando está libre de cualquier herramienta/material resultante del trabajo. Para reducir el riesgo de daños en la superficie de los azulejos, es necesario protegerla y evitar la presencia de materiales abrasivos. Al cabo de algunos días, eliminar los restos de la obra con una esponja comercial Scotch-Brite® o bien con un cepillo grande o monocepillo (para grandes superficies). Para los revestimientos, utilizar un detergente neutro diluido en agua caliente. Para los pavimentos, utilizar un detergente ácido tamponado, diluido en un porcentaje variable según el tipo de superficie (lisa o estructurada). Es importante proteger preventivamente con cinta adhesiva las inserciones de mármol o metal si estuvieran presentes. Aclarar abundantemente con agua caliente limpia hasta que desaparezca cualquier halo o residuo en los intersticios. Si fuera necesario, repetir el lavado ácido con concentraciones más elevadas, excepto si estuvieran presentes inserciones de mármol o metal. Evitar el empleo de ácidos muriáticos de escasa calidad diluidos.

#### 6B. MANTENIMIENTO ORDINARIO

Se recomienda el uso de un detergente neutro común diluido en agua.

Evitar el empleo de productos ácidos, alcalinos, productos para encerar y/o impermeabilizantes y bayetas de metal (esponjas de hierro y acero).

En caso de suciedad más intensa o superficies muy estructuradas, usar un detergente de base alcalina aclarando al final del lavado.

En caso de grandes superficies se recomienda el uso de máquinas de lavado y secado.

#### 6C. MANTENIMIENTO EXTRAORDINARIO

En caso de restos de suciedad resistentes a la limpieza ordinaria se recomienda el uso de un detergente adecuado dependiendo del tipo de suciedad.

TIPO DE SUCIEDAD (resistente al mantenimiento ordinario)	DETERGENTE/DISOLVENTE
Carbón, eflorescencias calcáreas, yeso, marcas metálicas, óxido, grafito, pinturas murales al temple	Detergentes de base ácida *
Coca cola, café, vino, cerveza, helado	Detergente de base alcalina
Resinas, aceites silicónicos o mecánicos, cera de vela, pintura	Disolventes
Neumáticos, suelas de goma, halos de ventosas	Detergentes básicos en pasta abrasiva

\* Atención: los productos de base ácida pueden corroer el mármol, el granito, las piedras naturales y los metales, por tanto hay que evitar su uso en caso de presencia de decoraciones o inserciones realizadas con estos materiales

Las características de limpieza de los materiales varían sensiblemente según las diferentes formas de instalación, las condiciones de uso, las tipologías de las superficies y el ambiente. Por lo general, cuanto mayores sean las características antideslizamiento de las baldosas, mayor será la dificultad para limpiarlas.

El profesional encargado del mantenimiento y la limpieza deberá siempre llevar a cabo una comprobación empírica previa (posiblemente en una porción de material no colocado) por cada tipo de intervención.

En caso de condiciones de uso especialmente pesadas (por ejemplo, en talleres mecánicos o en ambientes con una fuerte presencia de residuos oleosos y huellas de neumáticos), instalación incorrecta o limpieza efectuada de manera impropia, Atlas Concorde no se considera responsable de la eficacia de las operaciones de limpieza y mantenimiento.

Atlas Concorde no se considerará responsable de eventos, daños o defectos debidos a una instalación incorrecta, limpieza y mantenimiento negligentes o una elección inadecuada de los materiales instalados y los adhesivos utilizados con respecto al destino.

INDEX

A COMPLETE  
PRODUCT  
SYSTEMPRODUCT  
FINDERSURFACE  
RANGE

COMPANY



COLLECTIONS



LARGE SIZES

SLABS FOR  
COUNTERTOPS  
& FURNITURESINKS &  
BATHROOM  
FURNISHING

FACADES

TECHNICAL  
SPECIFICATIONS

## Рекомендации по укладке, чистке и уходу

### 1. УКЛАДКА

Перед укладкой рекомендуется проверить, что поверхность основания достаточно выдержана, ровная и чистая и что поставленная плитка соответствует требованиям по количеству, тону и калибру.

### 2. ВЫБОР КЛЕЯ

Для качества укладки крайне важно правильно подобрать клей. Рекомендуется следовать указаниям крупнейших изготовителей клеев по укладке керамических плиток.

В целом, клей выбирают с учетом следующих критериев:

- тип основания;
- типология и формат плитки;
- назначение (пол/стены; внутри/снаружи) керамического покрытия;
- климатические условия в период укладки;
- время на выполнение керамического покрытия.

НАЗНАЧЕНИЕ Тип основания	ТИП ПЛИТКИ Типология	ФОРМАТ (cm)	РЕКОМЕНДУЕМЫЕ КЛЕИ - Европейские Нормы EN 12004	
			Стандартное схватывание	Быстрое схватывание
<b>ВНУТРЕННИЕ НАПОЛЬНЫЕ ПОКРЫТИЯ</b>				
Цементные стяжки Прежние цементные полы (утрамбованные) Ангидритные стяжки (предварительно нанести нужную грунтовку) Стяжки с подогревом Укладка на существующие полы из керамики, мраморных плиток и природного камня Гидроизоляция в ванных	Керамогранит	< 30x30 cm	Улучшенные клеи на цементной основе с увеличенным сроком хранения в открытом состоянии (Класс C2E).	Улучшенные эластичные клеи на цементной основе, стойкие к оползанию (Класс C2FT - S1) ●
≥ 30x30 cm < 60x60 cm		Улучшенные клеи на цементной основе стойкие к оползанию с увеличенным сроком хранения в открытом состоянии (Класс C2TE).	Улучшенные эластичные клеи на цементной основе, стойкие к оползанию (Класс C2FT - S1) ●	
≥ 60x60 cm		Улучшенные клеи на цементной основе, стойкие к оползанию с увеличенным сроком хранения в открытом состоянии и эластичные (Класс C2E - S1).	Улучшенные эластичные клеи на цементной основе, стойкие к оползанию (Класс C2FT - S1) ●	
<b>ВНУТРЕННЯЯ ОБЛИЦОВКА</b>				
	плитка из белой глины	любой формат	Улучшенные клеи на цементной основе стойкие к оползанию с увеличенным сроком хранения в открытом состоянии (Класс C2TE).	Улучшенные эластичные клеи на цементной основе, стойкие к оползанию (Класс C2FT - S1) ●
Цементная штукатурка или раствор Гипс (штукатурка или панели, предварительно нанести нужную грунтовку) Бетонная заливка Гипсовые панели (После нанесения грунтовки на гипсовые швы) Гидроизоляция в ванных и душах Прежние керамические плитки		< 30x30 cm	Улучшенные клеи на цементной основе стойкие к оползанию с увеличенным сроком хранения в открытом состоянии (Класс C2TE).	Улучшенные эластичные клеи на цементной основе, стойкие к оползанию (Класс C2FT - S1) ●
≥ 30x30 cm < 60x60 cm		Улучшенные клеи на цементной основе стойкие к оползанию с увеличенным сроком хранения в открытом состоянии (Класс C2TE).	Улучшенные эластичные клеи на цементной основе, стойкие к оползанию (Класс C2FT - S1) ●	
		≥ 60x60 cm	Улучшенные клеи на цементной основе, стойкие к оползанию с увеличенным сроком хранения в открытом состоянии и эластичные (Класс C2E - S1).	Улучшенные эластичные клеи на цементной основе, стойкие к оползанию (Класс C2FT - S1) ●
<b>НАРУЖНЫЕ НАПОЛЬНЫЕ ПОКРЫТИЯ</b>				
		< 30x30 cm	Улучшенные клеи на цементной основе стойкие к оползанию с увеличенным сроком хранения в открытом состоянии (Класс C2TE).	Улучшенные эластичные клеи на цементной основе, стойкие к оползанию (Класс C2FT - S1) ●
Цементные стяжки Бетонное перекрытие Гидроизоляционные слои	Керамогранит	≤ 30x30 cm < 60x60 cm	Улучшенные клеи на цементной основе, стойкие к оползанию с увеличенным сроком хранения в открытом состоянии и эластичные (Класс C2TE - S1)	Улучшенные эластичные клеи на цементной основе, стойкие к оползанию (Класс C2FT - S1) ●
		≥ 60x60 cm	Улучшенные клеи на цементной основе, стойкие к оползанию с увеличенным сроком хранения в открытом состоянии и с большой эластичностью (Класс C2E - S2).	Улучшенные клеи на цементной основе, стойкие к оползанию с увеличенным сроком хранения в открытом состоянии и с большой эластичностью (Класс C2FE - S2) ●
<b>НАРУЖНАЯ ОБЛИЦОВКА</b>				
		< 30x30 cm	Улучшенные клеи на цементной основе, стойкие к оползанию с увеличенным сроком хранения в открытом состоянии и эластичные (Класс C2TE - S1)	Улучшенные эластичные клеи на цементной основе, стойкие к оползанию (Класс C2FT - S1) ●
Цементная штукатурка Бетонная заливка на месте или бетонные блоки	Керамогранит	≥ 30x30 cm < 60x60 cm ●●	Улучшенные клеи на цементной основе, стойкие к оползанию с увеличенным сроком хранения в открытом состоянии и эластичные (Класс C2TE - S1)	Улучшенные эластичные клеи на цементной основе, стойкие к оползанию (Класс C2FT - S1) ●
		≥ 60x60 cm ●●	Улучшенные клеи на цементной основе, стойкие к оползанию с увеличенным сроком хранения в открытом состоянии и с большой эластичностью (Класс C2E - S2).	Улучшенные высокоэластичные клеи на цементной основе (Класс C2F - S2) ●

- При укладке в условиях низкой температуры, если керамическое покрытие требуется быстро ввести в эксплуатацию, предпочтительнее применять быстросхватывающиеся улучшенные клеи на цементной основе (Класс C2F – EN 12004).
- Для плиток с длиной хотя бы одной из граней более 30 см, укладываемых на высоте более 3 метров, некоторые международные стандарты предусматривают дополнительное механическое крепление, например при помощи специальных крюков, для удержания плитки в случае случайного отрыва; крепеж подбирается с учетом веса плитки, высоты облицовки и конкретных условий стройплощадки.

### 3.УКЛАДКА ПЛИТКИ

Укладка должна производиться квалифицированными специалистами с использованием подходящих инструментов. Укладку плитки следует проверять до высыхания клея, чтобы при необходимости можно было сделать исправления. Atlas Concorde не рекомендует укладывать плитку без швов или со швом менее 2 мм.

При укладке плитки с длиной хотя бы одной из граней более 60 см и, в любом случае, при укладке плитки в коммерческих помещениях или на улице, клей следует наносить в два слоя: на подлежащее облицовке основание и на тыльную сторону плиток прямыми полосами параллельно короткой грани. Это обеспечит оптимальное сцепление плиток с основанием. Чтобы свести к минимуму неровности или перепады высот облицовки, как на полах, так и на стенах, рекомендуется использовать надлежащие крестики и системы выравнивания плитки; при укладке настенной глазурованной плитки из белой глины и (или) лапатированного керамогранита данные системы могут быть оснащены подкладками для защиты от сколов и царапин. В случае рельефной настенной плитки вместо системы с клиньями рекомендуется использовать винтовую систему выравнивания.

### 3А. УКЛАДКА ПРЯМОУГОЛЬНЫХ ФОРМАТОВ

При укладке вразбежку прямоугольных форматов смещение

плиток должно быть не более 1/3 длины смежных граней.

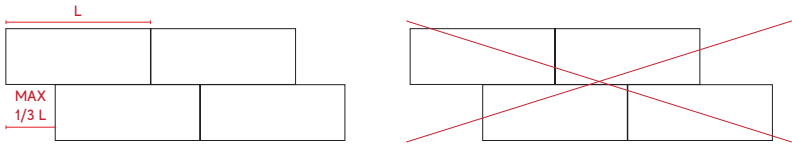

### 4. ВЫПОЛНЕНИЕ КВАДРАТНЫХ ИЛИ ПРЯМОУГОЛЬНЫХ ОТВЕРСТИЙ

Для выполнения квадратных или прямоугольных отверстий рекомендуется сначала просверлить круглые отверстия в каждом углу участка реза, затем соединить эти отверстия прямолинейной резкой. Это поможет ослабить напряжения по углам прорезаемого отверстия.

### 5. ШВЫ И ЗАТИРКА ШВОВ

Перед заполнением швов рекомендуется дождаться полного высыхания клея и убедиться, что в швах нет остатков клея и (или) пыли. В любом случае Atlas Concorde не рекомендует укладывать плитку без швов или со швом менее 2 мм. В случае швов, контрастных по цвету с уложенной плиткой, рекомендуем проверить затирку на небольшом скрытом участке укладки. При затирке швов следуйте указаниям крупнейших производителей шовных затирок.

НАЗНАЧЕНИЕ	РЕКОМЕНДУЕМЫЕ РАСТВОРЫ ЕВРОПЕЙСКИЕ НОРМАТИВЫ EN 13888
Внутренние жилые помещения	Улучшенные цементные растворы для швов (Класс CG2)
Внутренние помещения с высокой влажностью (ванные, души, бассейны и т.п.) и открытые помещения	Улучшенные цементные растворы для швов с низким водопоглощением (Класс CG2 W - EN 13888).
Помещения коммерческого назначения	Улучшенные цементные растворы для швов с повышенной стойкостью к истиранию (Класс CG2 Ar - EN 13888).
Помещения, где требуется полная гигиена и устойчивость к химическим агентам (рабочие столы на кухнях, пищевая промышленность, больницы, супермаркеты и т.п.)	Эпоксидные строительные растворы (Класс RG - EN 13888).

### 5А. УДАЛЕНИЕ ИЗЛИШКОВ ЗАТИРКИ

Чтобы легко и правильно удалить излишек раствора, рекомендуется следовать указаниям изготовителя раствора. В общих чертах рекомендуется придерживаться нижеуказанного.

**Цементные растворы**

Когда раствор теряет блеск (обычно через 10–20 минут), счистить его губкой из твердой целлюлозы, проводя ей по диагонали относительно швов. Очень важно выдержать определенное время, иначе есть риск удалить раствор из швов.

**Эпоксидные растворы**

Пока смесь свежая, обильно смочить поверхность, взбивая эмульсию тампоном Schotch-Brite®; действовать осторожно, чтобы не удалить раствор из швов. Жидкие остатки раствора можно удалить его губкой из твердой целлюлозы (вовремя заменяя ее, когда она сильно пропитывается смолой). Крайне важно удалить эпоксидный раствор вовремя, пока он не начал затвердевать, так как в дальнейшем это будет чрезвычайно трудно сделать. Если эпоксидный раствор уже начал затвердеть, можно попробовать добавить 10% спирта в воду для смывания.

### 6 ЧИСТКА И УХОД

### 6А. ЧИСТКА ПО ЗАВЕРШЕНИИ УКЛАДКИ

Плиточные работы можно считать законченными, когда строительная площадка полностью расчищена от материалов и инструментов, использованных в ходе работ. Чтобы снизить риск повреждения плиточного покрытия, необходимо защитить его и не допускать присутствия абразивных материалов. Через несколько дней очистить уложенное покрытие губкой марки Schotch-Brite®, щеткой или механической щеткой (для больших площадей). Для стен применять нейтральное моющее средство, растворенное в горячей воде. Для напольных покрытий применять кислотное моющее средство тампонированного действия, концентрация раствора меняется в зависимости от типа поверхности (гладкая или шершавая). Не забывать предварительно защитить мраморные или металлические вставки с помощью клейкой ленты. Прополоскать обильным количеством чистой горячей воды, удаляя все разводы и остатки в промежутках. При необходимости повторить кислотную промывку с более сильной концентрацией, за исключением случаев, когда на полу имеются мраморные или металлические вставки. Избегать применения разведенных кислот для металлов.

### 6В. ТЕКУЩИЙ УХОД

Рекомендуется пользоваться обычным нейтральным моющим средством, разведенным в воде. Избегать применения кислотных, щелочных, восковых средств, пропиток и металлических губок. Для удаления сильных загрязнений или для очистки шершавой поверхности с сильно рельефной структурой пользоваться моющим средством на щелочной основе, прополаскивая после мытья. Для уборки больших площадей рекомендуется пользоваться моечными машинами, которые выполняют мойку и сушку.

### 6С. ЧРЕЗВЫЧАЙНЫЙ УХОД

Если загрязнения не удается удалить обычным способом, рекомендуется применять моющее средство, подобранное с учетом типа загрязнения:

ТИП ЗАГРЯЗНЕНИЙ (устойчивых к обычной уборке)	МОЮЩЕЕ СРЕДСТВО/РАСТВОРИТЕЛЬ
Уголь, кальциевые налеты, гипс, следы от металлов, ржавчина, графит, стенная темпера	Моющие средства на кислотной основе *
Кока-кола, кофе, вино, пиво, мороженое	Моющие средства на щелочной основе
Смолы, силиконовые масла или масла для механического оборудования, свечной воск, краска	Растворители
Шины, резиновые подошвы, следы от присосок	Основания для очистки в виде абразивной пасты

\* Внимание: средства на кислотной основе могут вызвать коррозию мрамора, гранита, природного камня и металлов, поэтому их не следует применять, если имеются декоры или вставки из этих материалов.

Легкость очистки покрытий значительно меняется при различных способах укладки, условиях эксплуатации, типологиях поверхности и окружающей среды. В целом, чем менее скользкая литка, тем труднее ее очистить.

Профессиональный работник, отвечающий за уход и очистку, должен всегда провести предварительную пробу (по возможности, на неуложенном материале) по каждому отдельному виду работ.

В случае особо сложных условий (напр., механические мастерские или помещения с большим количеством масляных отходов и следов от шин), ошибок при укладке или неправильного проведения очистки фирма Atlas Concorde снимает с себя всякую ответственность за эффективность операций по очистке и уходу.

## INDEX



## A COMPLETE PRODUCT SYSTEM



## PRODUCT FINDER



## SURFACE RANGE



## COMPANY



## COLLECTIONS



## LARGE SIZES



## SLABS FOR COUNTERTOPS & FURNITURE



## SINKS & BATHROOM FURNISHING



## FACADES



## TECHNICAL SPECIFICATIONS



## Laying suggestions for outdoor

	installation method	product
<b>INDUSTRIAL AND COMMERCIAL AREAS FOR VEHICLES - AREE INDUSTRIALI E COMMERCIALI CARRABILI</b> ZONES INDUSTRIELLES ET ZONES COMMERCIALES AVEC PASSAGE DE VÉHICULES - BEFAHRBARE INDUSTRIE- UND GEWERBEFLÄCHEN ÁREAS INDUSTRIALES Y/O COMERCIALES TRAFICABLES - ПРОМЫШЛЕННЫЕ И (ИЛИ)КОММЕРЧЕСКИЕ ПРОЕЗЖИЕ УЧАСТКИ		
EN	Squares, public car parks, filling stations, paving for forklift trucks, pallet jacks, trailer trucks, buses, industrial platforms, etc.	Laying with adhesives using the "double buttering" method
IT	Piazze, parcheggi pubblici, stazioni di rifornimento, pavimentazioni con transito di carrelli elevatori, transpallet, autoarticolati, autobus, piattaforme industriali, ecc.	Posa con adesivi con il metodo della "doppia spalmatura"
FR	Places, parkings publics, stations-services, sols avec passage de chariots élévateurs, transpallettes, véhicules articulés, autobus, plateformes industrielles, etc.	Pose à l'aide de colles par la méthode du "double encollage"
DE	Plätze, öffentliche Parkplätze, Tankstellen, von Gabel-staplern, Handgabelhubwagen, Sattelschleppern, Bussen befahrene Böden, Industrieplattformen etc	Verlegung mit beidseitig aufgebrachtem Kleber (Butte-ring-Floating-Verfahren)
ESP	Centros comerciales, aeropuertos, lugares de culto, cole-gios, museos, plazas, hospitales, hoteles - hall de entrada, metros, estaciones de trenes, etc.	Colocación con materiales de agarre según el método de "doble encolado"
RU	Площадки, общественные парковки, заправочные станции, покрытия для проезда погрузчиков, гидравлических тележек, фур, автобусов, промышленные платформы и т.д.	Клеевая укладка с нанесением клея на монтажную сторону плитки и на облицовываемое основание

	installation method	product
<b>RESIDENTIAL AREAS FOR VEHICLES - AREE RESIDENZIALI CARRABILI</b> ZONES RÉSIDENTIELLES AVEC PASSAGE DE VÉHICULES - BEFAHRBARE BEREICHE IM WOHNUNGSBAU- UND GEWERBEFLÄCHEN ÁREAS RESIDENCIALES TRAFICABLES- ПРОЕЗЖИЕ УЧАСТКИ ПРИ ЖИЛЫХ ОБЪЕКТАХ		
EN	Outdoor courtyards, private homes, apartment complex parking lots (garages), etc. Pavements used only by cars.	Laying with adhesives using the "double buttering" method.
IT	Cortili esterni abitazioni private, parcheggi condominiali (garage interni), ecc. Pavimentazioni a transito esclusivo di autovetture.	Posa con adesivi con il metodo della "doppia spalmatura".
FR	Cours externes d'habitations individuelles, parkings d'immeuble (garages intérieurs), etc... Sols pour passage exclusivement de voitures.	Pose à l'aide de colles par la méthode du "double encollage".
DE	Außenhöfe und Parkplätze von Wohnhäusern, (Tiefgaragen) etc. Ausschließlich von Pkws befahrene Bodenbeläge.	Verlegung mit beidseitig aufgebrachtem Kleber (Butte-ring-Floating-Verfahren)
ESP	Patios exteriores de viviendas particulares, aparca-mientos de bloques multifamiliares (garajes interiores), etc. Pavimentos de tráfico exclusivo de automóviles.	Colocación con materiales de agarre según el método de "doble encolado".
RU	Дворы частных домов, парковки многоквартирных домов (внутренние гаражи) и т.п. Покрытия, предназначенные для проезда только легковых автомобилей.	Клеевая укладка с нанесением клея на монтажную сторону плитки и на облицовываемое основание

	installation method	product
<b>AREAS FOR PEDESTRIANS ONLY - AREE SOLO PEDONABILI</b> ZONES UNIQUEMENT PIÉTONNES- REINE FUSSGÄNGERBEREICHE ÁREAS SOLO PEATONALES- ПЕШЕХОДНЫЕ УЧАСТКИ		
EN	Patios, gardens and walkways, terraces, balconies, urban pedestrian areas, etc.	"Dry" laying (on grass, sand, and gravel) and raised Installation Laying with adhesives using the "double buttering" method
IT	Patii, giardini e camminamenti, terrazze, balconi, aree urbane pedonali, ecc.	Posa "a secco" (su erba, sabbia e ghiaia) e posa sopraelevata Posa con adesivi con il metodo della "doppia spalmatura"
FR	Patios, jardins et allées, terrasses, balcons, zones urbaines piétonnes, etc.	Pose "à sec" (sur herbe, sable ou graviers) et pose surélevée Pose à l'aide de colles par la méthode du "double encollage"
DE	Innenhöfe, Gärten und Gehwege, Terrassen, Balkone, städtische Fußgängerzonen etc.	Trockenverlegung (auf Gras, Sand und Kies) und erhöhte Verlegung Verlegung mit beidseitig aufgebrachtem Kleber (Butte-ring-Floating-Verfahren)
ESP	Patios, jardines y terraplenes, terrazas, balcones, áreas urbanas peatonales, etc.	Colocación "en seco" (sobre césped, arena y grava) y colocación elevada Colocación con materiales de agarre según el método de "doble encolado"
RU	Патио, сады, садовые дорожки, террасы, балконы, городские пешеходные площади и т.п.	Сухая бесклеевая укладка (на траву, песок, гравий) и укладка на опоры Клеевая укладка с нанесением клея на монтажную сторону плитки и на облицовываемое основание

	installation method	product
<b>POOL EDGES - BORDI PISCINA</b> BORDS DE PISCINE - SCHWIMMBECKENRÄNDER BORDES PISCINA- КРАЯ БАССЕЙНОВ		
EN	Pool edges	Laying with adhesives using the "double buttering" method
IT	Bordi piscina	Posa con adesivi con il metodo della "doppia spalmatura"
FR	Bords de piscine	ose à l'aide de colles par la méthode du "double encollage"
DE	Schwimmbeckänder	Verlegung mit beidseitig aufgebrachtem Kleber (Butte-ring-Floating-Verfahren)
ESP	Bordes piscina	Colocación con materiales de agarre según el método de "doble encolado"
RU	Края бассейнов	Клеевая укладка с нанесением клея на монтажную сторону плитки и на облицовываемое основание

INDEX



A COMPLETE PRODUCT SYSTEM



PRODUCT FINDER



SURFACE RANGE



COMPANY



COLLECTIONS



LARGE SIZES



SLABS FOR COUNTERTOPS &amp; FURNITURE



SINKS &amp; BATHROOM FURNISHING



FACADES



TECHNICAL SPECIFICATIONS



<sup>01</sup> For the properties of slip resistance required in the aforementioned uses it is always necessary to comply with the local laws, regulations and uses, referring to the technical sheets of the selected products. - Per le proprietà di resistenza allo scivolamento richieste nelle destinazioni d'uso sopra itate occorre sempre attenersi alle normative, leggi ed usi locali facendo riferimento alle schede tecniche dei prodotti selezionati. - Pour les propriétés de résistance à la glissade exigées par les destinations d'usage susmentionnées, il faut toujours respecter les normes, lois et réglementations locales en se référant aux fiches techniques des produits sélectionnés. - Für die von den obigen Zweckbestimmungen verlangte Rutschfestigkeit sind stets die örtlich geltenden Vorschriften, Gesetze und Gebräuche zu beachten. Siehe hierzu die technischen Datenblätter der gewählten Produkte. - Para las propiedades de resistencia al deslizamiento requeridas según los usos previstos antes indicados, es taxativo atenerse a las normativas, leyes y usos locales siempre consultando las fichas técnicas de los productos seleccionados. - Характеристики сопротивления скольжению при использовании плиток для вышеописанных назначений выбирают согласно местным законам, стандартам и правилам по листу технических характеристик выбранных изделий.

Porcelain tiles general packing and weight

Series Serie Série Serie Serie Серия	Size Formato Format Format Formato Размер	Pieces per carton Pezzi per scatola Pièces par boîte Stückzahl pro Karton Piezas por caja шт. в коробке	Sq mts per carton M <sup>2</sup> per scatola M <sup>2</sup> par boîte Om. pro Karton M <sup>2</sup> por caja M <sup>2</sup> в коробке	Box per pallet Box per pallet Boîtes par palette Karton pro Palette Cajas por palet Коробок на палете	Weight x ctn. (Kg.)* Peso per scatola (Kg.)* Poids x boîte (Kg.)* Gewicht pro Karton (Kg.)* Peso por caja (Kg.)* шт. вес коробки*	Sq mts per pallet M <sup>2</sup> per pallet M <sup>2</sup> par palette Om. pro Palette M <sup>2</sup> por palet M <sup>2</sup> на палете	Weight x pal. (Kg.)* Peso per pallet (Kg.)* Poids x pal. (Kg.)* Gewicht pro Palette (Kg.)* Peso por palet (Kg.)* вес палета*
Aix	75x150	2	2,25	18	47,36	40,50	852,48
	75x75	2	1,130	42	23,67	47,25	994,14
	37,5x75	4	1,130	48	22,16	54,00	1.063,68
	37,5x75 grip	4	1,130	48	23,68	54,00	1.136,64
Axi	60x90 20 mm	2	1,080	18	48,50	19,44	873,00
	22,5x90	6	1,220	36	25,20	43,74	907,20
Blaze	120x278 ▲	1	3,340	18	49,56	60,05	892,08
	120x120 ▲	2	2,880	20	58,00	57,60	1.160,00
	75x150	2	2,25	18	47,36	40,50	852,48
	75x75	2	1,130	42	23,68	47,25	994,56
Boost	120x120 20 mm ▲	1	1,440	20	67,66	28,80	1.353,20
	60x60 20 mm	2	0,720	30	33,00	21,60	990,00
	160x320 ▲	1	5,120	14	72,00	71,68	1.008,00
	160x160 ▲	1	2,560	24	36,00	61,44	864,00
	120x278 ▲	1	3,340	18	49,56	60,05	892,08
	120x240 ▲	1	2,880	18	58,00	51,84	1.044,00
	120x120 ▲	2	2,880	20	58,00	57,60	1.160,00
	120x120 6 mm ▲	2	2,880	20	40,32	57,60	806,40
	60x120	2	1,44	35	30,00	50,40	1.050,00
	75x150	2	2,25	18	47,36	40,50	852,48
Boost Mix	75x75	2	1,130	42	23,68	47,25	994,56
	60x60	3	1,080	40	20,01	43,20	800,40
	30x60	7	1,260	40	24,85	50,40	994,00
	120x240 20 mm ▲	1	2,880	9	134,00	25,92	1.206,00
	120x120 20 mm ▲	1	1,440	20	67,66	28,80	1.353,20
	60x120 20 mm	1	0,720	35	33,35	25,20	1.167,25
	90x90 20 mm	1	0,810	18	37,60	14,58	676,80
	60x60 20 mm	2	0,720	30	33,00	21,60	990,00
	120x278 ▲	1	3,34	18	49,56	60,05	892,08
	120x120 ▲	2	2,880	20	58,00	57,60	1.160,00
	60x120	2	1,44	35	30,00	50,40	1.050,00
	60x60	3	1,080	40	21,57	43,20	862,80
Boost Natural	30x60	7	1,26	40	24,85	50,40	994,00
	120x120 20 mm	1	1,44	20	67,66	28,80	1.353,20
	60x120 20 mm	1	0,72	35	33,35	25,20	1.167,25
	60x60 20 mm	2	0,72	30	33,00	21,60	990,00
	120x278 ▲	1	3,34	18	49,56	60,05	892,08
	120x120 ▲	2	2,88	20	58,00	57,60	1.160,00
	60x120	2	1,44	35	30,00	50,40	1.050,00
	60x60	3	1,08	40	21,57	43,20	862,80
	30x60	7	1,26	40	24,85	50,40	994,00
	120x120 20 mm ▲	1	1,44	20	67,66	28,80	1.353,20
	60x60 20 mm	2	0,72	30	33,00	21,60	990,00
	Boost Pro	160x320 ▲	1	5,120	14	72,00	71,68
160x160 ▲		1	2,560	24	36,00	61,44	864,00
120x278 ▲		1	3,340	18	49,56	60,05	892,08
120x240 ▲		1	2,880	18	58,00	51,84	1.044,00
120x120 ▲		2	2,880	20	58,00	57,60	1.160,00
120x120 6 mm		2	2,880	20	40,32	57,60	806,40
60x120		2	1,440	35	30,00	50,40	1.050,00
75x150		2	2,25	18	47,36	40,50	852,48
75x75		2	1,130	42	23,68	47,25	994,56
60x60		3	1,080	40	21,57	43,20	862,80
30x60		7	1,260	40	24,85	50,40	994,00
120x120 20 mm ▲		1	1,440	20	67,66	28,80	1.353,20
60x120 20 mm		1	0,720	35	33,35	25,20	1.167,25
90x90 20 mm		1	0,810	18	37,60	14,58	676,80
60x60 20 mm	2	0,720	30	33,00	21,60	990,00	
Boost Stone	120x278 ▲	1	3,34	18	49,56	60,05	892,08
	120x120 ▲	2	2,88	20	58,00	57,60	1.160,00
	60x120	2	1,44	35	30,00	50,40	1.050,00
	60x60	3	1,08	40	21,57	43,20	862,80
	30x60	7	1,26	40	24,85	50,40	994,00
	120x120 20 mm ▲	1	1,44	20	67,66	28,80	1.353,20
	60x120 20 mm	1	0,72	35	33,35	25,20	1.167,25
	60x60 20 mm	2	0,72	30	33,00	21,60	990,00
	75x150	2	2,250	18	47,36	40,50	852,48
	75x75	2	1,130	42	23,68	47,25	994,56
	45x90	3	1,220	36	24,50	43,74	882,00
	60x60	3	1,080	40	21,23	43,20	849,20
Brave	30x60	7	1,260	40	23,27	50,40	930,80
	30x60 grip	7	1,260	40	24,85	50,40	994,00
	120x120 20 mm ▲	1	1,440	20	67,66	28,80	1.353,20
	60x120 20 mm	1	0,720	35	33,35	25,20	1.167,25
	60x60 20 mm	2	0,720	30	33,00	21,60	990,00
	60x60 20 mm	2	0,720	30	33,00	21,60	990,00

\* +/- 10% The reported values do not include the weight of pallets. - I valori riportati non comprendono il peso dei pallet. - +/- 10% Les valeurs indiquées ne comprennent pas le poids des palettes. - +/- 10% - Die genannten Werte verstehen sich ohne das Gewicht der Paletten. - +/- 10% Los valores indicados no incluyen el peso de los palets. - +/- 10% Указанные значения не включают вес поддонов.  
 ▲ **Packaging on pallets also available on a-frames(see page 474)** - Imballato su pallet, disponibile anche imballato su cavalletto a pag. 474 - Emballage sur palette, également disponible page 474 - Verpackung auf Palette, auch auf Bock erhältlich - Seite 474 - Embalaje paletizado, también disponible en embalaje sobre caballetes en la página 474 - Упаковка на поддонах, возможна также упаковка на специальных подставках-стойках - стр. 474  
**February 2023**  
 Reported data can be subject to variations throughout the year, present values are updated on the date of catalogue printing.  
 I dati riportati possono subire delle variazioni nel corso dell'anno, i valori sono aggiornati al mese di stampa.  
**General packing and weight** - Imballi e Pesi - Emballage et poids - Verpackung und Gewicht - Pesos y embalaje - Упаковка и вес

Series Serie Série Serie Serie Серия	Size Formato Format Format Formato Размер	Pieces per carton Pezzi per scatola Pièces par boîte Stückzahl pro Karton Piezas por caja шт. в коробке	Sq mts per carton M <sup>2</sup> per scatola M <sup>2</sup> par boîte Om. pro Karton M <sup>2</sup> por caja M <sup>2</sup> в коробке	Box per pallet Box per pallet Boîtes par palette Karton pro Palette Cajas por palet Коробок на палете	Weight x ctn. (Kg.)* Peso per scatola (Kg.)* Poids x boîte (Kg.)* Gewicht pro Karton (Kg.)* Peso por caja (Kg.)* шт. вес коробки*	Sq mts per pallet M <sup>2</sup> per pallet M <sup>2</sup> par palette Om. pro Palette M <sup>2</sup> por palet M <sup>2</sup> на палете	Weight x pal. (Kg.)* Peso per pallet (Kg.)* Poids x pal. (Kg.)* Gewicht pro Palette (Kg.)* Peso por palet (Kg.)* вес палета*
Dwell	60x60	3	1,080	40	21,23	43,20	849,20
	120x120 ▲	2	2,880	20	58,00	57,60	1.160,00
Entice	18,5x150	4	1,110	40	23,68	44,40	947,20
	20x120	6	1,440	42	29,90	60,48	1.255,80
Etic	30x120 20 mm	2	0,720	36	33,00	25,92	1.188,00
	22,5x90	6	1,220	36	25,20	43,74	907,20
Etic Pro	25x150	3	1,130	30	23,68	33,75	710,00
	22,5x90	6	1,220	36	25,20	43,74	907,20
Exence	30x120 20mm	2	0,720	36	33,00	25,92	1.188,00
	18,5x150	4	1,110	40	23,68	44,40	947,20
Heartwood	20x120	6	1,440	42	31,10	60,48	1.306,20
	18,5x150	4	1,110	40	23,68	44,40	947,20
Klif	75x150	2	2,25	18	47,36	40,50	852,48
	75x75	2	1,130	42	23,68	47,25	994,56
Kone	37,5x75	4	1,130	48	23,68	54,00	1.136,64
	75x150	2	2,250	18	47,36	40,50	852,48
Lims	75x75	2	1,130	42	23,68	47,25	994,56
	60x60	3	1,080	40	20,61	43,20	824,40
Marvel	30x60	7	1,260	40	24,85	50,40	994,00
	120x120 ▲	2	2,880	20	58,00	57,60	1.160,00
	120x278 ▲	1	3,340	18	49,56	60,05	892,08
	120x120 ▲	2	2,880	20	58,00	57,60	1.160,00
	75x150	2	2,250	18	47,36	40,50	852,48
	75x75	2	1,130	42	25,00	54,00	1.200,00
	60x120 20 mm	1	0,720	35	33,35	25,20	1.167,25
	60x60 20 mm	2	0,720	30	33,00	21,60	990,00
	160x320 ▲	1	5,120	14	72,00	71,68	1.008,00
	160x160 ▲	1	2,560	24	36,00	61,44	864,00
	120x278 ▲	1	3,334	18	49,56	60,05	892,08
	120x240 ▲	1	2,880	18	58,00	51,84	1.044,00
Marvel Dream	120x120 ▲	2	2,880	20	58,00	57,60	1.160,00
	60x120	2	1,440	35	30,00	50,40	1.050,00
	75x150	2	2,25	18	47,36	40,50	852,48
	75x75	2	1,130	42	23,68	47,25	994,56
	60x60	3	1,080	40	21,23	43,20	849,20
	30x60	7	1,260	40	24,85	50,40	994,00
Marvel Edge	120x278 ▲	1	3,340	18	49,56	60,05	892,08
	120x240 ▲	1	2,880	18	58,00	51,84	1.044,00
	120x120 ▲	2	2,880	20	58,00	57,60	1.160,00
	60x120	2	1,440	35	30,00	50,40	1.050,00
	75x150	2	2,25	18	47,36	40,50	852,48
	75x75	2	1,130	42	23,68	47,25	994,56
Marvel Gala	60x60	3	1,080	40	21,23	43,20	849,20
	30x60	7	1,260	40	24,85	50,40	994,00
	120x278 ▲	1	3,340	18	49,56	60,05	892,08
	120x240 ▲	1	2,880	18	58,00	51,84	1.044,00
	120x120 ▲	2	2,880	20	58,00	57,60	1.160,00
	60x120	2	1,440	35	30,00	50,40	1.050,00
Marvel Pro	60x60	3	1,080	40	21,23	43,20	849,20
	160x320 ▲	1	5,120	14	72,00	71,68	1.008,00
	160x160 ▲	1	2,560	24	36,00	61,44	864,00
	120x278 ▲	1	3,340	18	49,56	60,05	892,08
	120x240 ▲	1	2,880	18	58,00	51,84	1.044,00
	120x120 ▲	2	2,880	20	58,00	57,60	1.160,00
Marvel Gems	60x120	2	1,440	35	30,00	50,40	1.050,00
	75x150	2	2,25	18	47,36	40,50	852,48
	75x75	2	1,130	42	23,68	47,25	994,56
	60x60	3	1,080	40	21,23	43,20	849,20
	30x60	7	1,260	40	24,85	50,40	994,00
	60x120	2	1,440	35	30,00	50,40	1.050,00

## Porcelain tiles general packing and weight

Series Serie Série Серия	Size Formato Format Formato Размер	Pieces per carton Pezzi per scatola Pièces par boîte Stückzahl pro Karton Piezas por caja щт. в коробке	Sq mts per carton M <sup>2</sup> per scatola M <sup>2</sup> par boîte Om. pro Karton M <sup>2</sup> por caja M <sup>2</sup> в коробке	Box per pallet Box per pallet Boîtes per palette Karton pro Palette Cajas por palet Коробок на палете	Weight x ctn. (Kg.)* Peso per scatola (Kg.)* Poids x boîte (Kg.)* Gewicht pro Karton (Kg.)* Peso por caja (Kg.)* щт. вес коробки*	Sq mts per pallet M <sup>2</sup> per pallet M <sup>2</sup> par palette Om. pro Palette M <sup>2</sup> por palet M <sup>2</sup> на палете	Weight x pal. (Kg.)* Peso per pallet (Kg.)* Poids x pal. (Kg.)* Gewicht pro Palette (Kg.)* Peso por palet (Kg.)* вес мalleta*	
Marvel Shine	160x320 ▲	1	5,120	14	72,00	71,68	1.008,00	
	160x160 ▲	1	2,560	24	36,00	61,44	864,00	
	120x278 ▲	1	3,340	18	49,56	60,05	892,08	
	120x240 ▲	1	2,880	18	58,00	51,84	1.044,00	
	120x120 lapp ▲	2	2,880	20	57,00	57,60	1.140,00	
	120x120 matte ▲	2	2,880	20	55,50	57,60	1.110,00	
	60x120	2	1,440	35	30,00	50,40	1.050,00	
	75x150	2	2,250	18	47,36	40,30	852,48	
	75x75	2	1,130	42	23,68	47,25	994,56	
	37,5x75	4	1,130	48	23,68	54,00	1.136,64	
	60x60	3	1,080	40	21,23	48,30	849,20	
	30x60	7	1,260	40	24,85	50,40	994,00	
	Marvel Stone	160x320 ▲	1	5,120	14	72,00	71,68	1.008,00
160x160 ▲		1	2,560	24	36,00	61,44	864,00	
120x278 ▲		1	3,340	18	49,56	60,05	892,08	
120x240 ▲		1	2,880	18	58,00	51,84	1.044,00	
120x120 ▲		2	2,880	20	58,00	57,60	1.160,00	
60x120		2	1,440	35	30,00	50,40	1.050,00	
75x150		2	2,250	18	47,36	40,50	852,48	
75x75		2	1,130	42	23,68	47,25	994,56	
60x60		3	1,080	40	21,23	43,20	849,20	
30x60		7	1,260	40	24,85	50,40	994,00	
Marvel Travertine		120x278 ▲	1	3,340	18	49,56	60,05	892,08
		120x240 ▲	1	2,880	18	58,00	51,84	1.044,00
		120x120 ▲	2	2,880	20	58,00	57,60	1.160,00
	60x120	2	1,440	35	30,00	50,40	1.050,00	
	60x60	3	1,080	40	21,23	43,20	849,20	
	60x120 20 mm	1	0,720	35	33,35	25,20	1.167,25	
	120x278 ▲	1	3,340	18	49,56	60,05	892,08	
	120x240 ▲	1	2,880	18	58,00	51,84	1.044,00	
	120x120 ▲	2	2,880	20	58,00	57,60	1.160,00	
	75x150	2	1,440	35	30,00	50,40	1.050,00	
Marvel X	75x75	2	1,130	42	23,68	47,25	994,56	
	60x120	2	1,440	35	30,00	50,40	1.050,00	
	60x60	3	1,080	40	21,23	43,20	849,20	
	30x60	7	1,260	40	24,85	50,40	994,00	
	60x120 20mm	1	0,720	35	33,35	25,20	1.167,25	
	Nid	25x150	3	1,130	30	23,68	33,75	710,40
		18,5x150	4	1,110	40	23,68	44,40	947,20
		15x90	10	1,350	36	26,67	48,60	960,12
Norde	60x120	2	1,440	35	30,00	50,40	1.050,00	
	60x60	3	1,080	40	21,57	43,20	862,80	
	30x60	7	1,260	40	24,85	50,40	994,00	
	60x120 20 mm	1	0,720	35	33,35	25,20	1.167,25	
	60x90 20 mm	2	1,080	18	48,50	19,44	873,00	
	80x80 20 mm	1	0,64	42	29,70	26,88	1.247,40	
	60x60 20 mm	2	0,72	30	33,00	21,60	990,00	
Prism	60x120 grip	1	8,00	1	157,00	8,00	157,00	
	120x278 ▲	1	3,340	18	49,56	60,05	892,08	
	120x120 ▲	2	2,880	20	58,00	57,60	1.160,00	
	60x120	2	1,440	35	30,00	50,40	1.050,00	
	60x60	3	1,080	40	21,57	43,20	862,80	
	30x60	7	1,260	40	24,85	50,40	994,00	
	120x120 20 mm ▲	1	1,440	20	67,66	28,80	1.353,20	
	80x80 20 mm ▲	1	0,64	42	29,70	26,88	1.247,40	
	60x60	3	1,080	40	20,01	43,20	800,40	
Trust	30x60	7	1,260	40	24,85	50,40	994,00	
	60x120 20 mm	1	0,720	35	33,35	25,20	1.167,25	
	60x60 20 mm	2	0,720	30	33,00	21,60	990,00	
Venti Boost	20x20	30	1,200	56	23,90	67,20	1.338,40	

## Wall tiles general packing and weight

Series Serie Série Серия	Size Formato Format Formato Размер	Pieces per carton Pezzi per scatola Pièces par boîte Stückzahl pro Karton Piezas por caja щт. в коробке	Sq mts per carton M <sup>2</sup> per scatola M <sup>2</sup> par boîte Om. pro Karton M <sup>2</sup> por caja M <sup>2</sup> в коробке	Box per pallet Box per pallet Boîtes per palette Karton pro Palette Cajas por palet Коробок на палете	Weight x ctn. (Kg.)* Peso per scatola (Kg.)* Poids x boîte (Kg.)* Gewicht pro Karton (Kg.)* Peso por caja (Kg.)* щт. вес коробки*	Sq mts per pallet M <sup>2</sup> per pallet M <sup>2</sup> par palette Om. pro Palette M <sup>2</sup> por palet M <sup>2</sup> на палете	Weight x pal. (Kg.)* Peso per pallet (Kg.)* Poids x pal. (Kg.)* Gewicht pro Palette (Kg.)* Peso por palet (Kg.)* вес мalleta*
3d Wall Carve	40x80	4	1,280	54	20,28	69,12	1.095,12
	50x120 matte	3	1,80	35	28,00	63,00	980,00
3d Wall Design	50x120 shiny	3	1,80	35	28,00	63,00	980,00
	50x120 matte	3	1,80	30	30,75	54,00	922,50
	40x80 matte	4	1,28	54	19,91	69,12	1.075,14
	40x80 shiny	4	1,28	54	18,80	69,12	1.015,20
	40x80 matte	4	1,28	48	20,06	61,44	962,88
	40x80 shiny	4	1,28	48	21,20	61,44	1.017,60
	30,5x56 matte	9	1,54	32	22,68	49,19	725,76
	30,5x56 matte	8	1,37	32	26,00	43,72	832,00
Aix Wall	40x80	4	1,280	54	19,00	69,12	1.026,00
	3D Row 40x80	4	1,280	48	21,20	61,44	1.017,60
Aplomb	50x120	3	1,800	35	28,00	63,00	980,00
Arty Wall	40x80	4	1,280	54	20,57	69,12	1.110,78
	3D Wave 40x80	4	1,280	48	21,20	61,44	1.017,60
Blaze Wall	50x120	3	1,800	35	28,00	63,00	980,00
Boost Wall	40x80	4	1,280	54	18,80	69,12	1.015,20
	3D Urban 40x80	4	1,280	48	21,20	61,44	1.017,60
Boost Natural Wall	50x120	3	1,800	35	28,00	63,00	980,00
	40x80	4	1,280	54	18,80	69,12	1.015,20
Boost Pro Wall	40x80	4	1,280	48	21,20	61,44	1.017,60
	3D Urban 40x80	4	1,280	48	21,20	61,44	1.017,60
Brave Wall	40x80	4	1,280	54	19,28	69,12	1.041,12
	3D Wave 40x80	4	1,280	48	21,20	61,44	1.017,60
	3D Blade 40x80	4	1,280	48	21,20	61,44	1.017,60
Lims Wall	40x80	4	1,280	54	19,00	69,12	1.026,00
	50x120	3	1,800	35	28,00	63,00	980,00
Marvel Wall	30,5x91,5	5	1,400	42	22,50	58,59	945,00
	40x80	4	1,280	54	20,28	69,12	1.095,12
	30,5x56	9	1,540	32	24,03	49,19	768,96
	8x31,5	20	0,500	84	8,10	42,34	680,40
	Marvel Dream Wall	50x120	3	1,800	35	28,00	63,00
40x80		4	1,280	54	19,00	69,12	1.026,00
Marvel Edge Wall	50x120	3	1,800	35	28,00	63,00	980,00
	30,5x91,5	5	1,400	42	21,55	58,59	905,10
	40x80	4	1,280	54	19,94	69,12	1.076,76
Marvel Pro Wall	8x31,5	20	0,500	84	8,10	42,34	680,40
	50x120	3	1,800	35	28,00	63,00	980,00
	40x80	4	1,280	54	19,00	69,12	1.026,00
Marvel Shine Wall	50x120	3	1,800	35	28,00	63,00	980,00
	40x80	4	1,280	54	19,00	69,12	1.026,00
Marvel Stone Wall	50x120	3	1,800	35	28,00	63,00	980,00
	40x80	4	1,280	54	19,00	69,12	1.026,00
	8x31,5	20	0,500	84	8,10	42,34	680,40
Prism Wall	50x120	3	1,800	35	28,00	63,00	980,00

\* +/- 10% The reported values do not include the weight of pallets. - I valori riportati non comprendono il peso dei pallets. - +/- 10% Les valeurs indiquées ne comprennent pas le poids des palettes. - +/- 10% - Die genannten Werte verstehen sich ohne das Gewicht der Paletten. - +/- 10% Los valores indicados no incluyen el peso de los palés. - +/- 10% Указанные значения не включают вес поддонов.

▲ Packaging on pallets, also available on a-frames(see page 474) - Imballo su pallet, disponibile anche imballo su cavalletto a pag. 474 - Emballage sur palette, emballage sur chevalet également disponible page 474 - Verpackung auf Palette, auch auf Bock erhältlich - Seite 474 - Embalaje paletizado, también disponible en embalaje sobre caballetes en la página 474 - Упаковка на поддону, возможна также упаковка на специальных подставках-стойках - стр. 474

February 2023  
Reported data can be subject to variations throughout the year, present values are updated on the date of catalogue printing.  
I dati riportati possono subire delle variazioni nel corso dell'anno, i valori sono aggiornati al mese di stampa.

A COMPLETE PRODUCT SYSTEM ➤

PRODUCT FINDER ➤

SURFACE RANGE ➤

COMPANY ➤

COLLECTIONS ➤

LARGE SIZES ➤

SLABS FOR COUNTERTOPS & FURNITURE ➤

SINKS & BATHROOM FURNISHING ➤

FACADES ➤

TECHNICAL SPECIFICATIONS ➤

## Large sizes general packing and weight

120x120 - 47 1/4" x 47 1/4" 120x240 - 47 1/4" x 94 1/2" 20x278 47 1/4" x 109 1/2" 160x160 - 63" x 63" 160x320 - 63" x 126" 162x324 - 63 3/4" x 127 1/2"

Packaging Imballo Boilage Verpackung Embalaje Упаковка	AS400 Code Codice AS400 Code AS400 Artikelcode AS 400 Código AS400 Код AS400	Packaging Size Dimensioni imballo Dimension Emballage Verpackungsmasse Dimensiones de Embalaje Размер Упаковки (cm)	Packaging weight Peso imballo Poids Emballage Verpackungsgewicht Peso Embalaje Вес Упаковки (kg)	Slabs size Formati Formats Formatgrösse Formatos Размер Плит (cm)	Max N° slabs Max N° pezzi N° Max de pièces Anzahl der Platten Max N° piezas Максимальное Количество Плит	Max Sqm Max Mq M² max Maximale qm Max M² Макс. M²	
120x120	Pallet Palette Palette Paleta Паллет	-	-	120x120x0,9 cm	40	57,60 mq	
				120x120x2,0 cm	20	28,8 mq	
	Wooden A-Frame Cavalletto di legno Chevalet en Bois A-Bock Holz Caballete de Madera Деревянная А-Опора	IMCD	130x75x158(h) cm	60 kg	120x120x0,9 cm	40	57,60 mq
					120x120x2,0 cm	20	28,8 mq
120x240	Wooden Crate Cassa di Legno Caisse en Bois Holzbox Caja de Madera Деревянный Ящик	IMCA	268x136x36(h) cm	82kg	120x240x0,9 cm	18	51,84 mq
					120x240x2,0 cm	9	25,92 mq
	Wooden A-Frame Cavalletto di Legno Chevalet en Bois A-Bock Holz Caballete de Madera Деревянная А-Опора	IMCE	250x75x159(h) cm	155kg	120x240x0,9 cm	36	103,6 mq
					120x240x2,0 cm	8	23,04 mq
120x278	Wooden Crate Cassa di Legno Caisse en Bois Holzbox Caja de Madera Деревянный Ящик	IMCB	292x145x34(h) cm	88kg	120x278x0,6 cm	18	60,05 mq
					Wooden A-Frame Cavalletto di Legno Chevalet en Bois A-Bock Holz Caballete de Madera Деревянная А-Опора	IMCF	290x75x159(h) cm
	Wooden Crate Kit Endless (only for kit Endless) Cassa di Legno Kit Endless (solo per kit Endless) Caisse en Bois Kit Endless (que pour le Kit Endless) Holzbox Kit Endless (nur für Endless Kit) Caja de Madera Kit Endless (solo para el kit Endless) Деревянный Ящик для Kit Endless (только для Kit Endless)	A6NZ	305x135x21(h) cm	52,5kg			
					Wooden Crate Cassa di Legno Caisse en Bois Holzbox Caja de Madera Деревянный Ящик	AØ5L	183x174x41(h) cm
Wooden A-Frame Cavalletto di Legno Chevalet en Bois A-Bock Holz Caballete de Madera Деревянная А-Опора	AØ5M	170x75x200(h) cm	103kg	160x160x0,6 cm			
				160x320 RT 162x324	IMCC	344x175x37(h) cm	139kg
162x324x0,6 cm	14	73,48 mq					
162x324x1,2 cm	8	40,96 mq					
162x324x2,0 cm	4	20,99 mq					
Wooden A-Frame Cavalletto di Legno Chevalet en Bois A-Bock Holz Caballete de Madera Деревянная А-Опора	IMCG	330x75x195(h) cm	206kg		160x320x0,6 cm	42	215,04 mq
					162x324x0,6 cm	42	220,45 mq
Iron A-Frame Cavalletto di ferro Chevalet en Fer A-Bock Metall Caballete de Hierro Металлическая Опора	IMCH	330x75x195(h) cm	176kg	162x324x1,2 cm	22	112,64 mq	
				162x324x2,0 cm	12	62,99 mq	
162x324	Bundles Only from Verona warehouse	-	-	30-40kg	160x320x0,6 cm	-	-
					162x324x0,6 cm	-	-
					162x324x1,2 cm	18	94,50 mq
					162x324x2,0 cm	12	63,00 mq

20' Container - Container 20 Piedi - Conteneur 20' - Contenedor de 20 Pies - 20' Контейнер 5,90x2,32x2,35(h) m	
Full 120x240 cm	nr. 11 crates - casse - caisses - Anzahl Holzboxen - cajas - количество ящиков 120x240 cm + 2 stands - cavalletti - chevalets - Anzahl A-Böcke - caballetes - количество опор 120x240 cm
Full 120x120x0,9 cm	nr. 16 crates - casse - caisses - Anzahl Holzboxen - cajas - количество ящиков 120x120x0,9 cm + 5 stands - cavalletti - chevalets - Anzahl A-Böcke - caballetes - количество опор 120x120x0,9 cm
Full 120x120x2 cm	nr. 12 crates - casse - caisses - Anzahl Holzboxen - cajas - количество ящиков 120x120x2 cm + 5 stands - cavalletti - chevalets - Anzahl A-Böcke - caballetes - количество опор 120x120x2 cm
Full 120x278 cm	nr. 6 stands - cavalletti - chevalets - Anzahl A-Böcke - caballetes - количество опор 120x278 cm
Full 120x278 cm	nr. 11 crates - casse - caisses - Anzahl Holzboxen - cajas - количество ящиков 120x278 cm + 2 stands - cavalletti - chevalets - Anzahl A-Böcke - caballetes - количество опор 120x278 cm
Full 160x320 cm	nr. 5 crates - casse - caisses - Anzahl Holzboxen - cajas - количество ящиков 160x320 cm (+ 4 spaces - spazi - places - Leerzeichen - espacios - пробелов 80x120 cm)
Full 160x320 cm	nr. 3 stands - cavalletti - chevalets - Anzahl A-Böcke - caballetes - количество опор 160x320 cm (+ 4 spaces - spazi - places - Leerzeichen - espacios - пробелов 80x120 cm)
Full 160x160 cm	nr. 15 crates - casse - crates - crates - crates - crates 160x160 cm
Full 160x160 cm	nr. 9 stands type 2 - cavalletti tipo 2 - chevalets type 2 - Anzahl A-Böcke Typ 2 - caballetes tipo 2 - количество опор тип 2 160x160 cm

40' Container - Container 40 piedi - Conteneur 40' - Contenedor de 40 Pies - 40' Контейнер 11,90x2,32x2,35(h) m	
Full 120x240 cm	nr. 12 stands - cavalletti - chevalets - Anzahl A-Böcke - caballetes - количество опор 120x240 cm
Full 120x240 cm	nr. 21 crates - casse - caisses - Anzahl Holzboxen - cajas - количество ящиков 120x240 cm + 4 stands - cavalletti - chevalets - Anzahl A-Böcke - caballetes - количество опор 120x240 cm
Full 120x240 cm	nr. 24 crates - casse - caisses - Anzahl Holzboxen - cajas - количество ящиков 1200x1200x0,9 cm
Full 120x120 cm	nr. 24 crates - casse - caisses - Anzahl Holzboxen - cajas - количество ящиков 120x120x2 cm
Full 120x278 cm	nr. 12 stands - cavalletti - chevalets - Anzahl A-Böcke - caballetes - количество опор 120x278 cm
Full 120x278 cm	nr. 21 crates - casse - caisses - Anzahl Holzboxen - cajas - количество ящиков 120x278 + 4 stands - cavalletti - chevalets - Anzahl A-Böcke - caballetes - количество опор 120x278 cm
Full 160x320 cm	nr. 15 crates - casse - caisses - Anzahl Holzboxen - cajas - количество ящиков 160x320 cm
Full 160x320 cm	nr. 9 stands - cavalletti - chevalets - Anzahl A-Böcke - caballetes - количество опор 160x320 cm
Full 160x160 cm	nr. 24 crates - casse - caisses - Anzahl Holzboxen - cajas - количество ящиков 160x160 cm
Full 160x160 cm	nr. 19 stands type 2 - cavalletti tipo 2 - stands type 2 - chevalets type 2 - Anzahl A-Böcke Typ 2 - caballetes tipo 2 - количество опор тип 2 60x160 cm

Truck, maximum loadable weight - Camion, peso massimo caricabile Camion, poids maximum chargeable - LKW maximal ladbares Gewicht - Camión, peso máximo cargable - Грузовик, максимальная загрузка		30 Ton.
Full 120x240 cm	nr. 20 crates - casse - caisses - Anzahl Holzboxen - cajas - количество ящиков 120x240 cm	
Full 120x120 cm	nr. 24 crates - casse - caisses - Anzahl Holzboxen - cajas - количество ящиков 120x120 cm	
Full 120x278 cm	nr. 20 crates - casse - caisses - Anzahl Holzboxen - cajas - количество ящиков 120x278 cm	
Full 160x320 cm	nr. 15 crates - casse - caisses - Anzahl Holzboxen - cajas - количество ящиков 160x320 cm	
Full 160x320 cm	nr. 9 stands - cavalletti - chevalets - Anzahl A-Böcke - caballetes - количество опор 160x320 cm	
Full 160x160 cm	nr. 27 crates - casse - caisses - Anzahl Holzboxen - cajas - количество ящиков 160x160 cm	
Full 160x160 cm	nr. 19 stands - cavalletti - chevalets - Anzahl A-Böcke - caballetes - количество опор 160x160	



## General sales conditions

### A.- CONTRACT COMPLETION

**A.1.** These general sales conditions govern every sales contract between the Seller and the Buyer and any amendment or exception thereof shall be agreed in writing.

**A.2.** Any offers, credits and/or rebates granted by agents or other intermediaries, shall not be considered valid if they are not confirmed in writing by the Seller.

A.3.- The Buyer shall send the written orders to the Seller, directly or through the agents, and the orders shall include the codes of the required products, quantity, price and destination. The order sent by the Buyer is irrevocable.

**A.4.** The sale shall be deemed completed when: (i) the Buyer receives a written confirmation from the Seller, via e-mail, fax or other electronic means, that complies with the terms and conditions of the order; or (ii) if the confirmation sent by the Seller contains conditions that differ from the order sent by the Buyer, when the latter accepts it in writing or in any case does not object within 7 (seven) days from reception; or (iii) if the Seller does not provide a written confirmation, when the products are delivered and loaded by the Buyer.

**A.5.** The Buyer shares the need to restrict the sales of Atlas Concorde products to the national territory. The Seller deems this rule necessary in order to coordinate its sales policy, streamline its distribution network and provide offers that are suited to the needs of the single countries. The Buyer acknowledges that this rule is also in its best interest.

The Buyer therefore undertakes to market the products supplied by Ceramiche Atlas Concorde SpA exclusively in its country of residence, refraining from promoting active sales, even online, with customers located in the territory of a country different from its own. As regards triangular operations, this undertaking applies to the country in which the buyer actually operates. The Buyer may resell the product outside its territory only with written authorisation from the Seller, or if the sales concern non first-grade products or products that are out of production.

### B.- PRICES

**B.1.** The prices agreed upon for each individual sale are net prices for cash delivery ex works (the Seller's plant shall be specified in the order confirmation), unless otherwise agreed in writing.

### C.- PRODUCT CHARACTERISTICS

**C.1.** The Buyer declares to have read and comply with the content of the following documentation published on the corporate website: 1) Laying, use, cleaning and maintenance manual and 2) Technical data sheets.

**C.2.** Given the intrinsic variability of the ceramic products, the characteristics of the samples, previously sent by the Seller to the Buyer, are purely illustrative and cannot be deemed binding.

**C.3.** Unless specifically requested and agreed before the order confirmation, the Seller does not guarantee that the entire quantity of an article on order shall be sent from one same production lot.

### D.- DELIVERY TERMS

**D.1.** The delivery terms are understood to be indicative and the extension thereof cannot entitle the Purchaser to request any form of compensation, without exception.

**D.2.** If, after 14 (fourteen) days from the date of notification that the goods are ready, the Purchaser fails to collect them, the Seller shall be forced for reasons of occupied space to return the goods to the storage facilities, thereby incurring additional costs; the Seller reserves the right to charge the Purchaser such additional costs.

### E.- SHIPPING ARRANGEMENTS AND TERMS

**E.1.** The Buyer must communicate any variation in the destination of the products, different from the one agreed in the order confirmation, in writing within, and no later than, the second day before the day foreseen for the collection at the Seller's premises. The Seller reserves the right not to accept the change of the product destination. If the actual destination of the product is different from the one stated by the Buyer, the Seller reserves the right to suspend the execution of the supplies underway and/or to terminate the contracts in force and the Buyer shall not have the right to claim direct and/or indirect compensation of any type.

**E.2.** Unless otherwise agreed, the goods shall be delivered ex-works (EXW - Incoterms 2010) and this shall also be the case when the parties agree that the delivery, or part of it, shall be arranged by the Seller on the Buyer's behalf. In any case, the risks shall transfer to the Buyer upon delivery to the first carrier.

**E.3.** Without prejudice to the Seller's extraneity in relation to the transport contract, the Seller shall not be indicated as "shipper" on the bill of lading. The communication of the gross weight of the container to the Forwarding agent does not represent in any way the undertaking of any liability by the Seller as regards the SOLAS (Safety Of Life At Sea) Convention. In no event may the said communication be taken to be the VGM (Verified

Gross Mass).

**E.4.** The Buyer undertakes to ensure that the vehicle sent to the Seller's warehouse is suitable for the loading operations, considering the nature of the products. If the vehicle sent to collect the goods causes difficulties in the loading operations, the Seller reserves the right to charge a penalty, of 4% of the value of the products, to cover the extra logistics costs. If the vehicle sent is not at all suitable, the Seller reserves the right to refuse to load the goods and the Buyer shall not have the right to claim compensation for any direct and/or indirect cost that may arise therefrom.

**E.5.** The Buyer is responsible for assigning the carrier the task of checking the products before loading them; any observations concerning the condition of the packaging and the correspondence of the quantities loaded with those on the transport document must be made by the carrier upon collection of the goods. The said observations must be written on all the copies of the transport documents, otherwise the loaded products shall be considered to be complete and in good condition. As a result, the Seller shall not be liable for any missing or damaged products not reported by the carrier.

**E.6.** The Buyer is also responsible for assigning the carrier the task of checking the loading procedure and the stability of the goods on the vehicle, in order to prevent damage during transport and to comply with all road safety provisions.

### F.- PAYMENTS

**F.1.** All payments must be made to the Seller's registered office. Payments made to agents, representatives, or sales assistants shall not be considered as made until the amounts are received by the Seller.

**F.2.** The Buyer shall not fulfil its payment obligations by making payments from countries other than its own country of residence, if the said countries do not guarantee an adequate exchange of information with Italy. In case of breach of the said prohibition, the Seller has the right to terminate the contract for just cause and the Buyer shall not have the right to claim compensation for any damage suffered.

**F.3.** Any costs for stamp duty and bank draft fees shall be borne by the Buyer. Failure to fulfil, even only in part, the payment shall result in the application of interest on arrears in favour of the Seller, from the date established for the payment, as envisaged by legislative decree 09/10/2002 no. 231.

**F.4.** Unless otherwise agreed in writing, the Buyer undertakes not to offset any receivables, of whatever nature, owed by the Seller.

### G.- CLAIMS

**G.1.** Upon receipt of the products, the Buyer shall perform a visual inspection in compliance with instructions provided in point 7 of UNI EN ISO 10545-2 standards.

**G.2.** The products must be installed and fitted strictly respecting the recommendations related to the activities to be performed before and during the laying of the product specified in document 1) Laying, use, cleaning and maintenance manual, published on the Seller's website, and on the product packaging and/or inside the packaging. Faults caused by an incorrect installation and by missing/incorrect maintenance (different from instructions provided in document 1) Laying, use, cleaning and maintenance manual), by an unsuitable use and/or by normal wear over time shall not be considered product faults.

**G.3.** With the exception of the limits of acceptability foreseen by the international EN 14411 (ISO 13006) standard, the parties acknowledge as identifiable faults those product defects that are immediately visible upon receipt thereof and that make the material unsuitable for use or that significantly reduce its value. This category includes faults as defined in the document 1) Laying, use, cleaning and maintenance manual, published on the Seller's website. Identifiable faults include, by way of a non-limiting example, superficial defects, decoration defects, defects concerning polishing, dimensions, surface flatness, straightness of sides/rectangularity and thickness, cracks, chippings or rough edges, non-compliant shades, mixed shades and products that feature problems deriving from the cutting process and/or from chips.

**G.4.** If the Buyer finds an identifiable fault, it must be reported in writing to the Seller, within 8 (eight) days from receipt of the products; failure to send the claim shall result in the forfeiture and loss of such right. The Buyer shall keep the entire lot of material readily available for the Seller. The claim shall include the invoice details and an accurate description of the claimed fault together with photographs, where possible. In the event that the claim proves to be unfounded, the Buyer shall refund the Seller any costs incurred for an inspection (expert's reports, travel, etc.).

**G.5.** Hidden faults shall be notified to the Supplier in writing, by recorded delivery letter with advice of receipt, within 8 days from the date such fault is found, under penalty of forfeiture.

**G.6.** The Buyer's right to make a claim for faults under warranty is valid for 12 (twelve) months from the delivery of the products.

### H.- WARRANTY FOR FAULTS

**H.1.** The Seller's warranty is limited to first grade products and not second or third grade products or lots on offer with special prices or discounts, which must be duly specified with a note in the order confirmation.

**H.2.** The Seller does not guarantee the suitability of the products for particular uses, and only guarantees the technical specifications published on the website in the document 2) Technical data sheets. The indication for use is merely indicative, even when written in the Seller's catalogues and manuals. On the basis of the characteristics described in the document 2) Technical data sheets, the designer always has the task of assessing the suitability of the product for the specific use conditions, taking into account the stress and variables to which the product will be subjected, which may alter its characteristics; for example, the traffic intensity, quality of traffic (foot traffic with the presence of sand, debris...), adverse weather conditions and any other unpredictable factor to which the material may be exposed.

**H.3.** In the event that identifiable product faults are ascertained, as defined in sub section G no. 3, the Seller shall replace the faulty product with another one with equal or superior characteristics; should this not be possible, the Seller shall apply a significant price reduction. Alternatively, following the return of the faulty products, the Buyer shall have the right to a refund of the price paid plus the transport cost, with the exclusion of compensation for any other direct and/or indirect damage.

**H.4.** The Seller's warranty shall not be valid if the products that have identifiable faults (totally or in part) have been used and/or in any case transformed, as this entails that the Buyer (or its customer) expressed the intention to accept them in the condition in which they were found.

**H.5.** In the event that hidden product faults are ascertained, the Seller's warranty is limited to the replacement with other products of equal or superior characteristics; should this not be possible the Seller shall refund the price paid plus the transport cost. In any case, the Seller's warranty for any direct and/or indirect damage caused by the faulty product, shall be limited to an amount that shall not be greater than double the selling price applied by the Seller, only in relation to the faulty part of the supply.

**H.6.** In the event that the Buyer resells the product to subjects protected by the consumer code (law decree no. 206/2005), the former shall be responsible for the conditions applied, if different from those stated herein, and shall ensure that the consumer's rights are exercised, in relation to the remedies and terms established by the said code. If there are the grounds for the Buyer to exercise the right of recourse and/or make a claim against the Seller/manufacturer, the said action shall take into account or go beyond the exemptions and limits established in sub sections G no. 1 and H no. 5.

### I. SOLVE ET REPETE (pay and then claim) AND TERMINATION CLAUSES

**I.1.** Pursuant to article 1462 of the Italian Civil Code, on no account may the Buyer suspend or delay payment of collected material, including in the event of alleged defects or faults in the material; this does not affect the right to claim back any payments made unduly (solve et repete).

**I.2.** If the Buyer's financial situation changes or in the event of non-payment (even partial) of products already supplied, the Seller reserves the right to suspend the execution of the supplies underway and/or to terminate the contracts in force and the Buyer shall not have the right to claim direct and/or indirect compensation of any type.

### L.- RETENTION OF OWNERSHIP

**L.1.** The products supplied shall remain exclusive property of the Seller until the Buyer has paid the full amount.

**L.2.** During the aforementioned period, the Buyer shall undertake the obligations and responsibilities as bailee (also referred to as custodian) and shall not transfer the said products, grant their use, let them be seized or distrained without declaring that the property is of the Seller, and the Buyer shall immediately inform the Seller by recorded delivery letter with advice of receipt.

### M.- FORCE MAJEURE

**M.1.** Each party may suspend the fulfilment of its contractual obligations, when the said fulfilment is impossible or objectively too costly due to an unforeseeable impediment independent from the parties, such as for example: strike, boycott, lockout, fire, war (declared or not), civil war, riots and revolutions, requisitions, embargo, power blackouts, extraordinary breakage of machinery, delays in the delivery of components or raw materials.

**M.2.** The party that wishes to apply this clause shall immediately notify the onset and end of the circumstances of force majeure to the other party in writing.

**M.3.** If the suspension due to force majeure lasts longer than 60 (sixty) days, each party

shall have the right to terminate this contract, with a notice of 10 (ten) days to be notified to the counterparty in writing.

### N.- CONFIDENTIALITY

**N.1.** The Buyer undertakes to maintain confidentiality as regards all information of a technical (such as, by way of a non-limiting example, drawings, tables, documentation, formulas and correspondence) and commercial nature (including contractual conditions, purchase prices, payment conditions,...) gained during the performance of this contract.

**N.2.** The confidentiality obligation shall be undertaken for the entire duration of this contract and for the period following its execution.

**N.3.** In case of failure to uphold the confidentiality obligation, the non-fulfilling party shall pay the other party compensation for all damages that may derive therefrom.

### O.- SELLER'S TRADEMARKS AND DISTINCTIVE SIGNS

**O.1.** The use of trademarks, ornamental designs and creative works in general, in whatever form and manner of expression (such as, by way of a non-limiting example: images, photos, drawings, videos, shapes, structures, etc.) constituting the Seller's intellectual property, through any means (such as, by way of a non-limiting example: press, video, radio, internet, social media, instant messaging platforms or VoIP, etc.) is strictly forbidden. Any exception to the said prohibition, even only partial, must be authorised in writing, each time, by the Seller's general management.

### P.- CONTRACT LANGUAGE, APPLICABLE LAW, JURISDICTION AND AUTHORITY

**P.1.** The present contract is drafted in Italian, and in case of disputes the said version shall prevail over any translations in other languages.

**P.2.** Any dispute concerning the supply of products shall be subject to Italian law and jurisdiction and the Court of Modena, the town in which the Seller has its registered office, shall have sole local jurisdiction.

For more information refer to the General Conditions of Sale, available at [www.atlasconcorde.com](http://www.atlasconcorde.com)

INDEX



A COMPLETE PRODUCT SYSTEM



PRODUCT FINDER



SURFACE RANGE



COMPANY



COLLECTIONS



LARGE SIZES



SLABS FOR COUNTERTOPS &amp; FURNITURE



SINKS &amp; BATHROOM FURNISHING



FACADES



TECHNICAL SPECIFICATIONS



## Condizioni generali di vendita

**A.- MODALITÀ DI CONCLUSIONE DEL CONTRATTO**

**A.1.** Le presenti Condizioni Generali di Vendita disciplinano ogni contratto di Vendita tra il Venditore e l’Acquirente ed ogni loro modifica o deroga deve essere concordata per iscritto.

**A.2.** Eventuali offerte, accrediti e/o abbuoni accordati da agenti o da altri intermediari, non sono ritenuti validi se non confermati per iscritto dal Venditore.

**A.3.** L’Acquirente invia al Venditore, direttamente o per il tramite di agenti, Ordini scritti che devono contenere l’indicazione dei codici dei Prodotti richiesti, delle quantità, del loro prezzo e della destinazione. L’Ordine inviato dall’Acquirente è irrevocabile.

**A.4.** La Vendita dovrà ritenersi conclusa nel momento in cui: (i) l’Acquirente riceva da parte del Venditore una Conferma scritta via e-mail, fax o altri mezzi telematici, conforme ai termini e alle condizioni dell’Ordine; o (ii) in caso di Conferma inviata dal Venditore contenente condizioni difformi dall’Ordine ricevute dall’Acquirente quando questi l’accetti per iscritto o comunque non la contesti entro 7 (sette) giorni dalla ricezione; o (iii) in assenza di conferma scritta da parte del Venditore, nel momento

in cui i Prodotti saranno consegnati e caricati dall’Acquirente.

**A.5.** L’Acquirente condivide l’esigenza di limitare al territorio nazionale le vendite di prodotti Atlas Concorde. Il Venditore ritiene questa regola elemento indispensabile per permettergli di coordinare la sua politica commerciale e razionalizzare la rete distributiva, con offerte più orientate alle necessità dei singoli Paesi.

Parimenti, l’Acquirente riconosce che tale esigenza costituisce una tutela anche dei propri interessi.

L’Acquirente si obbliga quindi a commercializzare i prodotti forniti da Ceramiche Atlas Concorde SpA esclusivamente nel suo Paese di residenza, astenendosi dal promuovere vendite attive sollecitate anche online con clienti situati nel territorio di uno Stato diverso dal proprio. Per le operazioni triangolari il presente obbligo si applica al Paese di effettiva operatività dell’acquirente. L’Acquirente potrà rivendere il prodotto al di fuori dal proprio territorio nel caso in cui riceva autorizzazione per iscritto da parte del Venditore, o nel caso in cui la rivendita riguardi prodotti non di prima scelta, oppure prodotti fuori produzione.

**B.- PREZZI**

**B.1.** Salvo diversa pattuizione scritta, i prezzi di vendita concordati di volta in volta si intendono al netto per contanti e per consegna franco stabilimento del Venditore indicato nella Conferma d’Ordine.

**C.- CARATTERISTICHE DEI PRODOTTI**

**C.1.** L’Acquirente dichiara di aver preso visione ed attenersi al contenuto della seguente documentazione pubblicata nel sito internet aziendale: 1) Manuale di Posa, Uso, Pulizia e Manutenzione e 2) Schede tecniche.

**C.2.** Data la intrinseca variabilità del prodotto ceramico, le caratteristiche dei campioni e/o modelli inviati in precedenza dal Venditore all’Acquirente sono da considerarsi indicativi e non vincolanti.

**C.3.** Salvo specifiche richieste da concordare prima della Conferma d’Ordine, il Venditore non garantisce che l’ordine del singolo articolo venga evaso tutto con un medesimo lotto di produzione.

**D.- TERMINI DI CONSEGNA**

**D.1.** I termini di consegna sono da intendersi indicativi e la proroga di essi non può far maturare all’Acquirente alcun diritto a richiedere indennizzi, ogni eccezione rimossa.

**D.2.** Se, trascorsi 14 (quattordici) giorni dalla data di avviso di merce pronta, l’Acquirente non ritira il materiale, il Venditore sarà costretto per ragioni di spazio occupato a riportare il materiale nelle locazioni di deposito, sostenendo quindi costi supplementari; il Venditore si riserva la possibilità di addebitare tali costi supplementari all’Acquirente.

**E.- RESA E SPEDIZIONE**

**E.1.** L’eventuale variazione della destinazione dei Prodotti, diversa da quella concordata in Conferma d’Ordine, deve essere comunicata dall’Acquirente per iscritto entro e non oltre il secondo giorno antecedente a quello previsto per il ritiro presso la sede del Venditore. Il Venditore si riserva la facoltà di non accettare la variazione della destinazione dei Prodotti. Nel caso si verifichi che la destinazione effettiva del Prodotto sia stata diversa da quella dichiarata dall’Acquirente, il Venditore si riserva la facoltà di sospendere l’esecuzione delle forniture in corso e/o risolvere i contratti in corso senza che l’Acquirente possa rivendicare risarcimenti

diretti e/o indiretti di alcun tipo.

**E.2.** Salvo patto contrario, la fornitura della merce si intende Franco Fabbrica (EXW ai sensi degli Incoterms 2010) e ciò anche quando sia convenuto che la spedizione o parte di essa venga curata dal Venditore su mandato dell’Acquirente. In ogni caso i rischi passano all’Acquirente al più tardi con la consegna al primo trasportatore.

**E.3.** Ferma restando l’estraneità del Venditore rispetto al contratto di trasporto, il Venditore non potrà essere indicato come “shipper” nella polizza di carico. La comunicazione del peso lordo del container allo spedizioniere, non costituisce alcuna assunzione di responsabilità da parte del Venditore ai fini della Convenzione SOLAS (Safety Of Life At Sea). In nessun caso tale comunicazione potrà essere intesa come VGM (Verified Gross Mass).

**E.4.** L’Acquirente s’impegna affinché il mezzo inviato presso i magazzini del Venditore sia idoneo al carico in relazione alla natura dei Prodotti. Nel caso il mezzo che si presenta comporti significative difficoltà per le operazioni di carico, il Venditore si riserva di addebitare una penale pari al 4% del valore dei prodotti a copertura dei maggiori costi logistici. Se il mezzo convenuto non è assolutamente idoneo, il Venditore si riserva la facoltà di negare le operazioni di carico senza che nulla possa essere richiesto dall’Acquirente a titolo di risarcimento per ogni onere diretto e/o indiretto che ne possa derivarne.

**E.5.** È compito dell’Acquirente incaricare il vettore di controllare i prodotti prima del carico; eventuali osservazioni in relazione all’integrità degli imballi e della rispondenza delle quantità caricate a quelle indicate sul documento di trasporto, devono essere sollevate dal vettore al momento del carico. Tali osservazioni devono essere riportate su tutte le copie dei documenti di trasporto, altrimenti i prodotti caricati s’intendono integri e completi. Ne deriva che il Venditore non si assume alcuna responsabilità in relazione a mancanze o danni dei prodotti non segnalati dal vettore.

**E.6.** È altresì responsabilità dell’Acquirente incaricare il vettore di verificare le modalità e la stabilità del carico sul mezzo affinché durante il trasporto non si verifichino rotture e affinché siano rispettate tutte le disposizioni di sicurezza riguardanti la circolazione stradale.

**F.- PAGAMENTI**

**F.1.** Qualsiasi obbligazione di pagamento deve essere adempiuta presso la sede legale del Venditore. Eventuali pagamenti ad agenti, rappresentanti o ausiliari di commercio non si intendono effettuati finché le relative somme non pervengono al Venditore.

**F.2.** È fatto divieto all’Acquirente di eseguire il proprio adempimento mediante pagamenti provenienti da paesi diversi dal proprio paese di residenza se trattasi di paesi che non garantiscono un adeguato scambio di informazioni con l’Italia. In caso di violazione di tale divieto, il Venditore ha facoltà di risolvere il contratto per giusta causa senza che l’Acquirente possa vantare il diritto di ottenere alcun risarcimento per l’eventuale danno subito.

**F.3.** Eventuali spese di bollo ed incasso effetti e tratte sono a carico dell’Acquirente. In caso di inadempimento, anche solo parziale, dal giorno fissato per il pagamento decorreranno a favore del Venditore gli interessi moratori nella misura prevista dal d.lgs. 09/10/2002 n. 231.

**F.4.** Salvo diversi accordi scritti, l’Acquirente si impegna a non compensare alcun credito, comunque insorto, nei confronti del Venditore.

**G.- RECLAMI**

**G.1.** Al ricevimento dei Prodotti, l’Acquirente dovrà sottoporli ad accurato controllo attraverso un esame visivo effettuato conformemente alle indicazioni riportate al punto 7 delle norme UNI EN ISO 10545-2

**G.2.** L’installazione e la posa dei Prodotti deve essere effettuata attenendosi scrupolosamente alle raccomandazioni inerenti le attività da svolgere prima e durante la posa in opera indicate nel documento 1) Manuale di Posa, Uso, Pulizia e Manutenzione pubblicato nel sito internet del Venditore e sulla confezione del prodotto e/o all’interno della stessa. Non sono considerati vizi del Prodotto quelli generati da un’errata installazione e dalla mancata/errata manutenzione (difformi dalle indicazioni fornite nel 1) Manuale di Posa, Uso, Pulizia e Manutenzione), da una non idonea destinazione d’uso e/o dalla normale usura nel tempo.

**G.3.** Fatti salvi i limiti di accettabilità previsti dalla norma internazionale EN 14411 (ISO 13006), le Parti riconoscono come Vizi Palesi i difetti dei Prodotti riscontrabili già al momento del loro ricevimento tali da rendere il materiale inidoneo all’uso o da diminuirne in modo apprezzabile il valore. Rientrano in tale categoria i difetti

come definiti nel documento 1) Manuale di Posa, Uso, Pulizia e Manutenzione pubblicato nel sito internet del Venditore. A titolo esemplificativo e non esaustivo si riconoscono come Vizi Palesi i difetti superficiali; i difetti di decorazione, di lappatura/levigatura, di calibro, di planarità, di ortogonalità-rettilinearità, di spessori, le crepe, le sbecature, i fuori tono, i toni mescolati e i Prodotti che presentano problemi da taglio/scaglie.

**G.4.** Nel caso l’Acquirente rilevi Vizi Palesi dovrà fare reclamo al Venditore per iscritto, a pena di decadenza, entro 8 (otto) giorni dal ricevimento e tenere a disposizione del Venditore l’intera partita di materiale. Il reclamo dovrà riportare i dati di fatturazione e una precisa descrizione del vizio reclamato corredata, quando possibile, da immagini fotografiche. Qualora il reclamo dovesse risultare infondato, l’Acquirente si rende disponibile a risarcire il Venditore delle spese sostenute per l’eventuale sopralluogo (perizie, viaggi ecc.).

**G.5.** I Vizi Occulti dovranno essere notificati al Venditore mediante lettera raccomandata A.R., a pena di decadenza dalla garanzia, entro 8 (otto) giorni dalla data della scoperta del difetto.

**G.6.** L’azione dell’Acquirente diretta a fare valere la garanzia per vizi si prescrive comunque nel termine di 12 (dodici) mesi decorrenti dalla consegna dei Prodotti.

**H.- GARANZIA PER VIZI**

**H.1.** La garanzia del Venditore si intende limitata ai soli Prodotti di prima scelta e non ai Prodotti di seconda o terza scelta o di partite d’occasione con prezzi o sconti particolari quando debitamente segnalati in nota nella Conferma dell’Ordine.

**H.2.** Il Venditore non garantisce l’idoneità dei Prodotti ad usi particolari, ma soltanto le caratteristiche tecniche pubblicate nel sito internet nel documento 2) Schede tecniche. L’indicazione d’uso, anche quando presentata dal Venditore in cataloghi e manuali, è da ritenersi puramente indicativa. Sulla base delle caratteristiche tecniche riportate nelle 2) Schede Tecniche è sempre compito del progettista valutare l’idoneità del Prodotto alle condizioni specifiche di utilizzo in funzione delle sollecitazioni e delle variabili che si possono verificare nell’ambiente di destinazione alterandone le sue caratteristiche, a titolo d’esempio, all’intensità del traffico, alla qualità del traffico (calpestio in presenza di sabbia, di detriti..), alle eventuali condizioni climatiche avverse e a qualsiasi altra aleatorietà a cui può essere esposto il materiale.

**H.3.** Nel caso risulti accertato che il Prodotto manifesti Vizi Palesi, come definiti al sub lett. G n.3, il Venditore provvederà alla sostituzione del Prodotto difettoso con altro avente caratteristiche pari o superiori o nel caso ciò non sia possibile ad una congrua riduzione del prezzo. In alternativa l’Acquirente avrà diritto, previa restituzione dei Prodotti viziati, al rimborso del prezzo pagato, maggiorato del costo del trasporto, con esclusione del risarcimento di ogni altro danno diretto e/o indiretto.

**H.4.** La garanzia del Venditore deve ritenersi esclusa nel caso in cui il Prodotto affetto da Vizi Palesi (in tutto o in parte) sia stato utilizzato e/o comunque trasformato dovendosi ritenere che in tal modo l’Acquirente (o il suo cliente) abbia espresso la volontà di accettarli nello stato in cui si trovano.

**H.5.** Nel caso risulti accertato che il Prodotto manifesti Vizi Occulti, la garanzia del Venditore è limitata alla sostituzione del materiale con altro avente caratteristiche pari o superiori e ove ciò non sia possibile al rimborso del prezzo pagato maggiorato del costo del trasporto. In ogni caso la garanzia del Venditore per ogni danno diretto e/o indiretto comunque originato dal prodotto difettoso, deve intendersi limitata ad una somma che non potrà superare il doppio del prezzo di vendita applicato dal Venditore in relazione alla sola parte della fornitura difettosa. **H.6.** Nel caso l’Acquirente rivenda il Prodotto a soggetti tutelati dal codice del consumo (d.l. n.206/2005) sarà responsabile delle condizioni praticate se difformi da quelle qui riportate e dovrà accertarsi che i diritti del consumatore siano esercitati nel rispetto dei rimedi e dei termini fissati da tale codice. Nel caso sussistano i presupposti, il diritto di regresso e/o comunque di rivalsa spettanti all’Acquirente verso il Venditore/produttore non potrà eccedere le esenzioni ed i limiti come fissati dal sub lett. G n.1 al sub lett. H n.5.

**I. CLAUSOLE SOLVE ET REPETE E RISOLUTIVE**

**I.1.** Ai sensi dell’art. 1462 del Codice Civile, per nessun motivo, ivi compresi pretesi vizi o difetti del materiale, l’Acquirente potrà sospendere o ritardare il pagamento del materiale ritirato, salva naturalmente la facoltà di ripetere quando possa dimostrare di avere indebitamente pagato.

**I.2.** Nel caso di mutamento delle condizioni patrimoniali dell’Acquirente o di mancato pagamento anche parziale di prodotti già forniti, il Venditore può **sospendere**

l’esecuzione delle forniture in corso e/o risolvere i contratti in corso senza che l’Acquirente possa rivendicare risarcimenti diretti e/o indiretti di alcun tipo.

**L.- PATTO DI RISERVATO DOMINIO**

**L.1.** Fino a quando l’Acquirente non avrà provveduto all’integrale pagamento del prezzo, i Prodotti oggetto della fornitura rimarranno di proprietà del Venditore. **L.2.** Durante il periodo suddetto, l’Acquirente assumerà gli obblighi e le responsabilità del custode, e non potrà alienare, dare in uso, lasciare sequestrare o pignorare tali Prodotti senza dichiarare la proprietà del Venditore e dare immediato avviso a mezzo raccomandata A.R.

**M.- FORZA MAGGIORE**

**M.1.** Ciascuna parte potrà sospendere l’esecuzione dei suoi obblighi contrattuali quando tale esecuzione sia resa impossibile o oggettivamente troppo onerosa da un impedimento imprevedibile indipendente dalla sua volontà, quale ad esempio: sciopero, boicottaggio, serrata, incendio, guerra (dichiarata o non), guerra civile, sommosse e rivoluzioni, requisizioni, embargo, interruzioni di energia, rotture straordinarie di macchinari, ritardi nella consegna di componenti o materie prime. **M.2.** La parte che desidera avvalersi della presente clausola dovrà comunicare immediatamente per iscritto all’altra parte il verificarsi e la cessazione delle circostanze di forza maggiore.

**M.3.** Qualora la sospensione dovuta a forza maggiore duri più di 60 (sessanta) giorni, ciascuna parte avrà il diritto di risolvere il presente contratto, previo un preavviso di 10 (dieci) giorni, da comunicarsi alla controparte per iscritto.

**N.- OBBLIGO DI RISERVATEZZA**

**N.1.** L’Acquirente è tenuto ad osservare la più assoluta riservatezza su tutte le notizie di carattere tecnico (quali, in via meramente esemplificativa, disegni, prospetti, documentazioni, formule e corrispondenza) e di carattere commerciale (ivi comprese le condizioni contrattuali, i prezzi d’acquisto, le condizioni di pagamento ..) apprese in esecuzione del presente Contratto.

**N.2.** L’obbligo di riservatezza viene assunto per tutta la durata del Contratto, nonché per il periodo successivo alla sua esecuzione.

**N.3.** In ogni caso di inosservanza dell’obbligo di riservatezza, la parte inadempiente è tenuta e risarcire all’altra tutti i danni che ne dovessero derivare.

**O.- MARCHI E SEGNI DISTINTIVI DEL VENDITORE**

**O.1.** L’utilizzo dei marchi, dei modelli ornamentali e delle opere d’ingegno in genere, in qualunque forma o modo di espressione (quali a titolo meramente esemplificativo, ma non esaustivo: immagini, foto, disegni, filmati, figure, strutture, etc.) costituenti proprietà intellettuale del Venditore, attraverso qualsiasi mezzo (quali a titolo meramente esemplificativo, ma non esaustivo: stampa, video, radio, internet, social media, piattaforme di messaggistica istantanea o VoIP, etc.) è severamente vietato. Qualsiasi deroga a tale divieto, anche solamente parziale, dovrà essere autorizzata per iscritto, caso per caso, dalla Direzione generale del Venditore.

**P.- LINGUA DEL CONTRATTO, LEGGE APPLICABILE, GIURISDIZIONE E COMPETENZA**

**P.1.** Il Contratto e le presenti condizioni sono redatti in lingua Italiana, la quale prevarrà nel caso di divergenza con la traduzione in altre lingue.

**P.2.** La definizione di qualsiasi controversia comunque relativa alle forniture è soggetta alla legge ed alla giurisdizione dello Stato Italiano e la competenza territoriale viene devoluta in via esclusiva al Tribunale di Modena nella cui circoscrizione il Venditore ha la sua sede legale.

Per maggiori informazioni riferirsi alle Condizioni Generali di Vendita, disponibili all’indirizzo [www.atlasconcorde.com](#)

### INDEX



### TECHNICAL SPECIFICATIONS

### INDEX

### A COMPLETE PRODUCT SYSTEM



### PRODUCT FINDER



### PRODUCT FINDER



### PRODUCT FINDER



### PRODUCT FINDER



### PRODUCT FINDER



### PRODUCT FINDER



### PRODUCT FINDER



### PRODUCT FINDER



### PRODUCT FINDER



### PRODUCT FINDER



### PRODUCT FINDER



### PRODUCT FINDER



### PRODUCT FINDER



### PRODUCT FINDER



### PRODUCT FINDER



### PRODUCT FINDER



### PRODUCT FINDER



### PRODUCT FINDER



### PRODUCT FINDER



### PRODUCT FINDER



### PRODUCT FINDER



### PRODUCT FINDER



## Conditions générales de vente

### A.- MODALITÉS DE CONCLUSION DU CONTRAT

**A.1.** Les présentes Conditions Générales de Vente régissent tout contrat de Vente entre le Vendeur et l'Acheteur et toute modification ou dérogation de ces dernières doit être convenue par écrit.

**A.2.** D'éventuelles offres, accréditations et / ou ristournes accordées par des agents ou par d'autres intermédiaires, ne seront réputées valables que si elles sont confirmées par écrit par le Vendeur.

**A.3.** L'Acheteur envoie au Vendeur, directement ou par l'intermédiaire d'agents, des Commandes écrites qui doivent indiquer les codes des Produits demandés, les quantités, leur prix et leur destination. La commande envoyée par l'Acheteur est irrévocable.

**A.4.** La Vente doit être réputée conclue au moment où: (i) l' Acheteur reçoit de la part du Vendeur une Confirmation écrite par e-mail, par télécopie ou par d'autres moyens télématiques, conforme aux conditions de la Commande ; ou (ii) en cas de Confirmation envoyée par le Vendeur contenant des conditions différant de la Commande envoyée par l'Acheteur lorsque celui-ci l'accepte par écrit ou quoi qu'il en soit s'il ne la conteste pas dans un délai de 7 (sept) jours à compter de la réception ; ou (iii) en l'absence d'une confirmation écrite de la part du Vendeur, au moment où les Produits seront livrés et chargés par l'Acheteur.

**A.5.** L'Acheteur partage l'exigence de limiter les ventes de produits Atlas Concorde au territoire national. Le Vendeur considère cette règle comme un élément indispensable lui permettant de coordonner sa politique commerciale et de rationaliser le réseau de distribution, avec des offres davantage orientées vers les exigences des différents Pays. De même, l'Acheteur reconnaît que cette exigence constitue également une mesure de protection de ses propres intérêts. L'Acheteur s'engage donc à commercialiser les produits fournis par Ceramiche Atlas Concorde SpA exclusivement dans son Pays de résidence, en s'abstenant de promouvoir les ventes actives également sollicitées en ligne auprès de clients situés sur le territoire d'un État différent du sien.

Pour les opérations triangulaires, la présente obligation s'applique au pays dans lequel l'acheteur opère effectivement. L'Acheteur pourra revendre le produit hors de son territoire avec l'autorisation écrite du Vendeur, ou si la revente concerne des produits qui ne sont pas de premier choix ou des produits hors production.

### B.- PRIX

**B.1.** Sauf accord contraire, les prix de vente convenus au fur et à mesure sont réputés nets, pour les paiements en espèces et les livraisons Franco l'établissement du Vendeur indiqué sur la Confirmation de Commande.

### C.- CARACTÉRISTIQUES DES PRODUITS

**C.1.** L'Acheteur déclare avoir lu et s'en tenir au contenu de la documentation suivante publiée sur le site Internet de la société: 1) Manuel de Pose, d'Utilisation, de Nettoyage et d'Entretien et 2) Fiches techniques.

**C.2.** Vu la variabilité intrinsèque du produit en céramique, les caractéristiques des échantillons et / ou des modèles envoyés précédemment par le Vendeur à l'Acheteur sont indicatifs et non contraignants.

**C.3.** Sauf en cas de demandes spécifiques à convenir avant la Confirmation de Commande, le Vendeur ne garantit pas la commande d'un article soit intégralement constituée par un même lot de production.

### D.- DÉLAIS DE LIVRAISON

**D.1.** Les délais de livraison sont indicatifs et leur éventuelle prorogation ne confère à l'Acheteur aucun droit de demander une indemnisation, sans aucune exception.

**D.2.** Si, après 14 (quatorze) jours à compter de l'avis de mise à disposition des marchandises, l' Acheteur ne retire pas le matériel, le Vendeur sera dans l'obligation, en raison de la place occupée, de ramener le matériel dans le dépôt, supportant ainsi des coûts supplémentaires ; le Vendeur se réserve la possibilité de facturer ces coûts supplémentaires à l'Acheteur.

### E.- LIVRAISON ET EXPÉDITION

**E.1.-** L'éventuelle variation de la destination des Produits, différente de celle convenue dans la Confirmation de Commande, doit être communiquée par l'Acheteur par écrit au plus tard le second jour qui précède le jour du retrait au siège du Vendeur. Le Vendeur se réserve la faculté de ne pas accepter la variation de la destination des Produits. Au cas où la destination effective du Produit serait différente de celle déclarée par l'Acheteur, le Vendeur se réserve la faculté de suspendre l'exécution des fournitures en cours et / ou de résilier le contrat sans que l'Acheteur puisse

revendiquer des indemnisations directes et / ou indirectes d'aucune sorte.

**E.2.** Sauf accord contraire, la fourniture de la marchandise est livrée Départ Usine (EXW aux termes des Incoterms 2010) même si l'on a convenu que l'expédition ou une partie de cette dernière sera suivie par le Vendeur sur mandat de l'Acheteur. En tout état de cause, les risques passent à l'Acheteur au plus tard au moment de la livraison au premier transporteur.

**E.3.** Sans préjudice du désintérêt du Vendeur par rapport au contrat de transport, celui-ci ne pourra être indiqué comme le "shipper" dans le connaissance. La communication du poids brut du container à l'expéditeur, ne constitue pas une prise de responsabilité de la part du Vendeur aux fins de la Convention SOLAS (Safety Of Life At Sea). En aucun cas cette communication ne pourra être considérée comme le VGM (Verified Gross Mass).

**E.4.** L'Acheteur s'engage à ce que le véhicule envoyé aux entrepôts du Vendeur soit compatible avec la nature des Produits à charger. Si le véhicule qui se présente comporte des difficultés significatives pour les opérations de chargement, le Vendeur se réserve la faculté de débiter une pénalité de l'ordre de 4 % de la valeur des produits pour couvrir les coûts logistiques supplémentaires. Si le véhicule convenu n'est absolument pas compatible, le Vendeur se réserve la faculté de refuser les opérations de chargement sans que l'Acheteur ne puisse rien lui demander à titre de remboursement de toute dépense directe et / ou indirecte éventuelle.

**E.5.** Il appartient à l'Acheteur de charger le transporteur de contrôler les produits avant le chargement ; d'éventuelles observations concernant l'intégrité des emballages et la correspondance des quantités chargées avec celles indiquées sur le document de transport doivent être soulevées par le transporteur au moment du chargement. Ces observations doivent être indiquées sur toutes les copies des documents de transport ; dans le cas contraire, les produits chargés sont réputés intacts et complets. Il s'ensuit que le Vendeur décline toute responsabilité en cas d'absence ou de détérioration des produits non signalée par le transporteur.

**E.6.** L'Acheteur a également la responsabilité de charger le transporteur de vérifier les modalités et la stabilité du chargement sur le véhicule afin d'éviter les bris durant le transport et le respect de toutes les dispositions de sécurité concernant la circulation sur route.

### F.- PAIEMENTS

**F.1.** Toute obligation de paiement doit être accomplie au siège légal du Vendeur. Les éventuels paiements remis à des agents, à des représentants ou à des auxiliaires de commerce ne seront réputés effectués qu'au moment où le Vendeur percevra les sommes correspondantes.

**F.2.** Il est interdit à l'Acheteur d'effectuer des paiements depuis un pays différent de son pays de résidence et ne garantissant pas un échange d'informations correct avec l'Italie. En cas de violation de cette interdiction, le Vendeur a la faculté de résilier le contrat pour juste cause sans que l'Acheteur ne puisse revendiquer le droit d'obtenir une quelconque réparation pour l'éventuel préjudice subi.

**F.3.** Les éventuels frais de timbre et d'encaissement d'effets et de traites sont à la charge de l'Acheteur. En cas de défaillance, même partielle, des intérêts de retard commencent à courir en faveur du Vendeur, à compter du jour fixé pour le paiement, dans la mesure prévue par le Décret Législatif italien n° 231 du 09/10/2002.

**F.4.** Sauf accord écrit contraire, l' Acheteur s'engage à ne compenser aucune créance échue.

### G.- RÉCLAMATIONS

**G.1.** À la réception des Produits, l' Acheteur devra soumettre ces derniers à un contrôle minutieux moyennant un examen visuel effectué conformément aux indications du point 7 des normes UNI EN ISO 10545-2.

**G.2.** L'installation et la pose des Produits doivent être effectuées en suivant scrupuleusement les recommandations inhérentes aux activités exercées avant et durant la pose indiquées sur le document 1) Manuel de Pose, d'Utilisation, de Nettoyage et d'Entretien, publié sur le site Internet du Vendeur ainsi qu'à l'extérieur et/ ou à l'intérieur de l'emballage du produit. Les défauts dus à une installation erronée et à un entretien absent / erroné (ne respectant pas les indications fournies dans le 1) Manuel de Pose, d'Utilisation, de Nettoyage et d'Entretien), par un usage prévu inapproprié et / ou par l'usure normale due au temps ne sont pas considérés comme des vices du Produit.

**G.3.** Sous réserve des limites d'acceptabilité prévues par la norme internationale EN 14411 (ISO 13006), les Parties reconnaissent comme des Vices Évidents les défauts des Produits existant dès la réception de sorte que le matériel devienne

inutilisable ou qu'il perde une grande partie de sa valeur. Cette catégorie comprend les défauts définis dans le document 1) Manuel de Pose, d'Utilisation, de Nettoyage et d'Entretien publié sur le site Internet du Vendeur. À titre d'exemple non contraignant, on reconnaît comme des Vices Évidents les défauts de surface, de décoration, de polissage, de calibre, de planéité, d'orthogonalité–rectitude, d'épaisseur, les fissures, les ébréchés, les hors nuance, les nuances mélangées et les Produits qui présentent des problèmes de coupe – voile.

**G.4.** Si l' Acheteur relève des Vices Évidents, il devra présenter une réclamation écrite au Vendeur, sous peine de déchéance, dans un délai de 8 (huit) jours à compter de la réception et tenir le lot complet de matériel à la disposition de ce dernier. La réclamation devra indiquer les données de facturation et une description précise du vice objet de la réclamation, accompagnée, si possible, de photographies. Si la réclamation devait s'avérer sans fondement, l' Acheteur est disposé à rembourser au Vendeur les dépenses encourues pour l'éventuelle visite des lieux (expertises, déplacements, etc.).

**G.5.** Les Vices Cachés devront être notifiés au Vendeur par lettre recommandée avec avis de réception, sous peine d'annulation de la garantie, dans un délai de 8 (huit) jours à compter de la date de la découverte du défaut.

**G.6.** L'action de l' Acheteur ayant pour but de faire valoir la garantie en cas de vices se prescrit dans un délai de 12 (douze) mois à compter de la livraison des Produits.

#### H.- GARANTIE COUVRANT LES VICES

**H.1.** La garantie du Vendeur est réputée limitée aux seuls Produits de premier choix et non aux Produits de second ou de troisième choix ou à des lots d'occasion auquel on applique des prix ou des remises particuliers lorsqu'ils sont dûment signalés dans les notes de la Confirmation de Commande.

**H.2.** Le Vendeur ne garantit pas l'adéquation des Produits à des usages particuliers, mais uniquement les caractéristiques techniques publiées sur le site Internet dans le document 2) Fiches techniques. L'usage indiqué, également lorsqu'il est présenté par le Vendeur dans des catalogues et des manuels, est purement indicatif. Sur la base des caractéristiques techniques indiquées dans les 2) Fiches Techniques, le concepteur a toujours le devoir d'évaluer l'adéquation du Produit aux conditions spécifiques d'utilisation en fonction des contraintes et des variables pouvant se vérifier dans le lieu de destination et susceptibles d'en altérer les caractéristiques, par exemple, l'intensité et la qualité de la circulation (piétinement en présence de sable, de détritüs..), ainsi que les éventuelles conditions climatiques défavorables et toute autre incidence à laquelle peut être exposé le matériel.

**H.3.** Si l'on a constaté que le Produit présente les Vices Évidents définis à la lettre G n°3, le Vendeur remplacera le Produit défectueux par un autre produit ayant des caractéristiques analogues ou supérieures ou, lorsque cela est impossible, à une réduction cohérente du prix. En alternative, l' Acheteur aura droit, après la restitution des Produits défectueux, au remboursement du prix payé, majoré du prix du transport, à l'exclusion du remboursement de tout autre préjudice direct et / ou indirect.

**H.4.** La garantie du Vendeur doit être réputée exclue au cas où le Produit présentant des Vices Évidents (entièrement ou partiellement) aurait été utilisé et / ou du moins transformé ; dans ce cas, on considèrera que l' Acheteur (ou son client) a exprimé la volonté de les accepter en l'état.

**H.5.** Si l'on a constaté que le Produit présente des Vices Cachés, la garantie du Vendeur se limite au remplacement du matériel par du matériel ayant des caractéristiques analogues ou supérieures et, lorsque cela est impossible, au remboursement du prix payé majoré des frais de transport. En tout état de cause, la garantie du Vendeur couvrant tout dommage direct et / ou indirect causé par le produit défectueux, se limitera à une somme qui ne pourra pas dépasser le double du prix de vente appliqué par le Vendeur dans le cadre de la seule partie de la fourniture défectueuse.

**H.6.** Si l' Acheteur revend le Produit à des clients protégés par le code de la consommation (Décret-loi italien n° 206/2005) il sera responsable des conditions appliquées si celles-ci diffèrent des conditions indiquées ici et il devra s'assurer que les droits du consommateur sont exercés dans le respect des remèdes et des délais fixés par ce code. Si les conditions sont réunies, le droit de retrait et / ou de recours revenant à l' Acheteur à l'encontre du Vendeur / fabricant ne pourra dépasser ni les exonérations ni les limites établies de la lettre G n°1 à la lettre H n°5.

### I. CLAUSES SOLVE ET REPETE ET CLAUSES RÉSOLUTOIRES

**I.1.** Aux termes de l'art. 1462 du Code Civil italien, en aucun cas, y compris les prétendus vices ou défauts du matériel, l' Acheteur ne pourra suspendre ou retarder le paiement du matériel retiré, sans préjudice naturellement de la faculté d'exiger lorsqu'il est en mesure de démontrer avoir indûment payé.

**I.1.** En cas de variation des conditions patrimoniales de l' Acheteur ou de non-paiement même partiel de produits déjà fournis, le Vendeur se réserve la faculté de suspendre l'exécution des fournitures en cours et / ou de résilier les contrats sans que l' Acheteur ne puisse revendiquer des indemnisations directes et / ou indirectes d'aucune sorte.

#### L.- PACTE DE RÉSERVE DE PROPRIÉTÉ

**L.1.** Tant que l' Acheteur n'aura pas intégralement payé le prix, les Produits objet de la fourniture resteront la propriété du Vendeur.

**L.2.** Au cours de la susdte période, l' Acheteur assumera les obligations et les responsabilités de gardien, et il ne pourra ni aliéner, ni confier, ni permettre la saisie desdits Produits sans déclarer la propriété du Vendeur et informer immédiatement ce dernier par lettre recommandée avec avis de réception.

#### M.- FORCE MAJEURE

**M.1.** Chacune des parties pourra suspendre l'accomplissement de ses obligations contractuelles lorsque cette exécution est rendue impossible ou objectivement trop onéreuse par un empêchement imprévisible indépendant de sa volonté comme : les grèves, les boycottages, les lock-outs, les incendies, les guerres (déclarées ou non), les guerres civiles, les révoltes et les révolutions, les réquisitions, les embargos, les coupures de courant, les ruptures exceptionnelles de machines, les retards de livraison de composants ou de matières premières.

**M.2.** La partie qui souhaite user de la présente clause devra communiquer immédiatement par écrit à l'autre partie la survenue et la cessation des circonstances de force majeure.

**M.3.** Si la suspension due à une force majeure dure plus de 60 (soixante) jours, chacune des parties aura le droit de résilier le présent contrat, avec un préavis de 10 (dix) jours, en le communiquant par écrit à la partie adverse.

#### N.- OBLIGATIONS DE CONFIDENTIALITÉ

**N.1.** L' Acheteur est tenu d'observer le secret le plus absolu concernant toutes les informations de caractère technique (comme, par exemple, les dessins, les notices, les documentations, les formules et la correspondance) et de caractère commercial (y compris les conditions contractuelles, les prix d'achat, les conditions de paiement, etc.) dont il aurait eu connaissance durant l'exécution du présent Contrat.

**N.2.** L'obligation de confidentialité est assumée pendant toute la durée du Contrat, ainsi que pour la période successive à son exécution.

**N.3.** Dans tous cas de non-observation de l'obligation de confidentialité, la partie défailtante est tenue de réparer à l'autre partie tous les éventuels préjudices.

### O.- MARQUES ET SIGNES DISTINCTIFS DU VENDEUR

**O.1.** L'utilisation des marques, des modèles ornementaux et des œuvres de l'esprit en général, sous quelque forme ou suivant quelque modalité d'expression que ce soit (à titre d'exemple, non contraignant : les images, les photos, les dessins, les vidéos, les figures, les structures, etc.) constituant la propriété intellectuelle du Vendeur, à travers tout moyen (à titre d'exemple non contraignant : l'impression, la vidéo, la radio, Internet, les médias sociaux, les plates-formes de messagerie instantanée ou VoIP, etc.) est formellement interdite. Toute dérogation à cette interdiction, même partielle, devra être autorisée par écrit, cas par cas, par la Direction générale du Vendeur.

#### P.- LANGUE DU CONTRAT, LOI APPLICABLE, JURIDICTION ET COMPÉTENCE

**P.1.** Le Contrat et les présentes conditions sont rédigés en langue italienne qui prévaudra en cas de divergence avec la traduction dans d'autres langues.

**P.2.** La définition de toute controverse relative aux fournitures est régie par la loi et la juridiction de l'État italien et les parties reconnaissent la compétence territoriale exclusive du Tribunal de Modène dans la circonscription duquel se trouve le siège légal du Vendeur.

Pour plus de renseignements, consulter les Conditions générales de vente qui sont disponibles à l'adresse www.atlasconcorde.com

## Allgemeine Verkaufsbedingungen

### A.- MODALITÄT DES VERTRAGSABSCHLUSSES

**A.1.** Die vorliegenden Allgemeinen Verkaufsbedingungen regeln alle Verträge zwischen dem Verkäufer und dem Käufer und alle Änderungen oder Abweichungen davon müssen schriftlich vereinbart werden.

**A.2.** Eventuelle Angebote sowie mit Handelsvertretern oder sonstigen Vermittlern vereinbarten Gutschriften sind nicht verbindlich, es sei denn, sie werden vom Verkäufer schriftlich bestätigt.

**A.3.** Der Käufer sendet dem Verkäufer direkt oder über Handelsvertreter schriftliche Bestellungen zu, die die Angabe der Artikelnummern der gewünschten Produkte, der Mengen, ihres Preises und der Bestimmung enthalten müssen. Die vom Käufer gesendete Bestellung ist unwiderruflich.

**A.4.** Der Verkauf gilt zu dem Zeitpunkt als abgeschlossen, an dem: (i) der Käufer vom Verkäufer eine schriftliche Bestätigung per E-Mail, Fax oder auf sonstigem Weg erhält, die den Fristen und Bedingungen der Bestellung entspricht; oder (ii) falls die vom Verkäufer gesendete Bestätigung, Bedingungen enthält, die von der vom Käufer erhaltenen Bestellung abweichen, wenn dieser diese akzeptiert oder nicht innerhalb von 7 (sieben) Tagen ab ihrem Empfang beanstandet; oder (iii) falls keine schriftliche Bestätigung durch den Verkäufer erfolgt, zu dem Zeitpunkt, an dem die Produkte geliefert und vom Käufer übernommen werden.

**A.5.** Der Käufer teilt die Notwendigkeit, das nationale Gebiet für die Verkäufe der Produkte von Atlas Concorde zu unterteilen. Der Verkäufer hält diese Regel für ein unverzichtbares Element, um es ihm zu gestatten, seine kommerzielle Politik zu koordinieren und sein Vertriebsnetz mit Angeboten für die Erfordernisse der einzelnen Länder zu rationalisieren. Außerdem erkennt der Käufer an, dass diese Notwendigkeit auch zum Schutz der eigenen Interessen dient. Der Käufer verpflichtet sich daher, die von Ceramiche Atlas Concorde SpA gelieferten Produkte ausschließlich in dem Land zu vertreiben, in dem er seinen Firmensitz hat, und den aktiven Verkauf – auch online – an Kunden mit Sitz in einem anderen Staat zu unterlassen. Für Dreiecksgeschäfte wird die vorliegende Pflicht auf das Land angewendet, in dem der Käufer effektiv tätig ist.

Der Käufer kann das Produkt außerhalb seines eigenen Gebiets verkaufen, falls er die schriftliche Genehmigung des Verkäufers einholt, oder falls der Verkauf nicht Produkte erster Wahl oder Produkte außerhalb der Produktion betrifft.

### B.- PREISE

**B.1.** Vorbehaltlich abweichender schriftlicher Vereinbarungen gelten die von Mal zu Mal vereinbarten Verkaufspreise als Nettobarpreise bar mit Lieferung frei ab dem in der Auftragsbestätigung angegebenen Werk des Verkäufers.

### C.- EIGENSCHAFTEN DER PRODUKTE

**C.1.** Der Käufer erklärt, die folgende auf der Web-Site des Unternehmen veröffentlichte Dokumentation zur Kenntnis genommen zu haben und sich an deren Inhalt zu halten: 1) Handbuch zur Verlegung, Benutzung, Reinigung und Pflege, und 2) Technische Datenblätter.

**C.2.** Aufgrund der intrinsischen Variabilität des Keramikprodukts sind die Eigenschaften der vorausgehend vom Verkäufer an den Käufer gesendeten Warenmuster und/oder Modelle hinweisend und unverbindlich.

**C.3.** Vorbehaltlich spezifischer Vereinbarungen vor der Auftragsbestätigung garantiert der Verkäufer nicht, dass die Lieferung des einzelnen Artikels vollständig mit dem gleichen Produktionslos ausgeführt wird.

### D.- LIEFERFRISTEN

**D.1.** Die Lieferbedingungen sind richtungsweisend; durch eine eventuelle Verlängerung entsteht für den Käufer ausnahmslos kein Recht auf Schadenersatz.
**D.2.** Wenn der Käufer das Material nicht innerhalb von 14 (vierzehn) Tagen ab der Mitteilung der Bereitstellung der Ware abholt, ist der Verkäufer aus Platzgründen gezwungen, das Material an die Lagerorte zurückzubringen, wodurch zusätzliche Kosten entstehen; der Verkäufer behält sich das Recht vor, dem Käufer diese zusätzlichen Kosten in Rechnung zu stellen.

### E.- RÜCKLIEFERUNG UND VERSAND

**E.1.** Die eventuelle Änderung des Bestimmungsortes der Produkte, die sich von der in der Auftragsbestätigung vereinbarten unterscheidet, muss vom Käufer schriftlich innerhalb des zweiten Tags vor dem für die Abholung am Sitz des Verkäufers vorgesehenen mitgeteilt werden. Der Verkäufer behält sich das Recht vor, die Änderung der Bestimmung der Produkte nicht zu akzeptieren. Falls sich herausstellt, dass die effektive Bestimmung des Produkts von der vom Käufer angegebenen verschieden ist, behält sich der Verkäufer das Recht vor, die laufenden Lieferungen

nicht auszuführen und/oder die laufenden Verträge aufzulösen, ohne dass der Käufer jeglichen Anspruch auf Entschädigung geltend machen kann.

**E.2.** Vorbehaltlich abweichender Vereinbarungen erfolgt die Lieferung der Ware frei ab Werk (EXW gemäß den Incoterms 2010), und dies auch, falls vereinbart wird, dass der Versand oder ein Teil desselben im Auftrag des Käufers durch den Verkäufer erfolgt. In jedem Fall gehen die Risiken spätestens mit der Übergabe an das erste Transportunternehmen an den Käufer über.

**E.3.** Unter Beibehaltung der Nichtbeteiligung des Verkäufers am Transportvertrag kann der Verkäufer in der Police der Ladung als „Shipper“ angegeben werden. Die Mitteilung des Bruttogewichts des Containers an den Transportunternehmer stellt keine Übernahme der Verantwortung des Verkäufers hinsichtlich der SOLAS-Konvention dar (Safety Of Life At Sea). In keinem Fall kann diese Mitteilung als VGM (Verified Gross Mass) verstanden werden.

**E.4.** Der Käufer verpflichtet sich sicherzustellen, dass das zu den Lagern des Verkäufers gesendete Fahrzeug unter Berücksichtigung der Natur der Produkte für das Laden geeignet ist. Falls das zum Laden gesendete Fahrzeug größere Probleme beim Beladen bereitet, behält der Verkäufer sich das Recht vor, zur Abdeckung der höheren Logistikkosten eine Vertragsstrafe in Höhe von 4 % des Werts der Produkte zu erheben. Falls das Fahrzeug vollkommen ungeeignet ist, behält sich der Verkäufer das Recht vor, das Verladen zu verweigern, ohne dass der Käufer einen Anspruch auf Vergütung der Schäden geltend machen kann, die direkt und/oder indirekt daraus entstehen können.

**E.5.** Es ist Aufgabe des Käufers, das Transportunternehmen zu beauftragen und die Produkte vor dem Laden zu kontrollieren; eventuelle Anmerkungen zur Unversehrtheit der Verpackungen und der Übereinstimmung der geladenen Menge mit der in den Transportpapieren angegebenen müssen vom Transportunternehmen zum Zeitpunkt des Ladens vorgenommen werden. Diese Anmerkungen müssen auf alle Exemplaren der Transportpapiere vermerkt werden, anderenfalls gelten die geladenen Produkte als unbeschädigt und vollständig. Daraus folgt, dass der Verkäufer keinerlei Haftung für Fehlmengen oder Beschädigungen der Produkte übernimmt, die vom Transportunternehmen nicht gemeldet werden.

**E.6.** Es ist ebenfalls Aufgabe des Käufers, das Transportunternehmen zu beauftragen und die Modalität und die Stabilität des Ladens auf das Fahrzeug zu überprüfen, damit es während des Transports nicht zu Brüchen kommt, sowie die Einhaltung der Sicherheitsbestimmungen der Straßenverkehrsordnung zu gewährleisten.

### F.- ZAHLUNGEN

**F.1.** Alle Zahlungsverpflichtung müssen am Firmensitz des Verkäufers erfüllt werden. Eventuelle Zahlungen an Handelsvertreter oder Außendienstmitarbeiter gelten als nicht geleistet, bis sie beim Verkäufer eingehen.

**F.2.** Es ist dem Käufer untersagt, die Zahlungen aus Ländern vorzunehmen, die vom Land seines Firmensitzes verschieden sind, falls diese Länder keinen angemessenen Informationsaustausch mit Italien gewährleisten. Im Fall der Verletzung dieses Verbots hat der Verkäufer das Recht, den Vertrag aus gutem Grund aufzulösen, ohne dass der Käufer eine Vergütung des entstandenen Schadens geltend machen kann.

**F.3.** Eventuelle Kosten und Gebühren für die Einziehung von Effekten und Wechseln gehen zu Lasten des Käufers. Im Fall der Nichteinhaltung des für die Zahlung festgesetzten Tags – auch nur partiell – fallen Säumniszinsen zu Gunsten des Verkäufers an, in der vom ital. Gesetzerlass vom 9. Oktober 2002, Nr. 231 vorgesehenen Höhe.

**F.4.** Vorbehaltlich abweichender schriftlicher Vereinbarungen verpflichtet sich der Käufer, keine Guthaben gegenüber dem Verkäufer zu verrechnen.

### G.- BEANSTANDUNGEN

**G.1.** Beim Empfang der Produkte muss der Käufer sie einer sorgfältigen Sichtkontrolle gemäß den Angaben von Punkt 7 der Normen UNI EN ISO 10545-2 unterziehen.
**G.2.** Die Installation und die Verlegung der Produkte müssen unter Einhaltung der Empfehlungen zu den Arbeiten ausgeführt werden, die vor und während der Verlegung ausgeführt werden müssen, wie angegeben im Dokument 1) Handbuch zur Verlegung, Verwendung, Reinigung und Pflege, veröffentlicht auf der Web-Site des Verkäufers und angegeben auf der Verpackung des Produkts und/oder im Inneren derselben. Schäden, die durch eine falsche Installation, Verlegung und durch eine unterlassene/falsche Pflege (abweichend von den Angaben in 1) Handbuch zur Verlegung, Reinigung und Wartung), durch eine ungeeignete Gebrauchsbestimmung oder durch normale Abnutzung verursacht werden, werden nicht als Mängel des Produkts anerkannt.

**G.3.** Vorbehaltlich der Grenzen der Akzeptabilität, die von der internationalen

Norm EN 14411 (ISO 13006) vorgesehen sind, erkennen die Parteien Mängel der Produkte als offensichtliche Mängel an, die bereits bei ihrem Empfang festgestellt werden können, die das Material zur Verwendung ungeeignet machen oder die den Wert beträchtlich verringern. In diese Kategorie fallen Mängel, wie im Dokument definiert 1) Handbuch zur Verlegung, Benutzung, Reinigung und Pflege, veröffentlicht auf der Web-Site des Verkäufers. Als nicht erschöpfende Beispiele werden Oberflächenmängel, fehlerhafte Grafik, Defekte polierte Oberfläche, Defekte des Kalibers, der Planarität, der Rechtwinkligkeit/Gradlinigkeit, der Stärke, Risse, abgeschlagene Kanten, Fehlfarbe, gemischte Brandfarbe sowie Produkte mit Kantsplitterung durch Rettifizierung als offensichtliche Mängel anerkannt.

**G.4.** Falls der Käufer offensichtliche Mängel feststellt, muss er dies dem Verkäufer innerhalb von 8 (acht) Tagen ab dem Empfang schriftlich melden und die gesamte Charge des Materials für den Verkäufer zur Verfügung halten; anderenfalls verfällt der Rechtsanspruch. Bei der Beanstandung müssen die Daten der Rechnung sowie eine präzise Beschreibung des beanstandeten Mangels angegeben werden, falls möglich mit einer fotografischen Dokumentation. Falls die Beanstandung unberechtigt sein sollte, ist der Käufer gehalten, dem Verkäufer die für einen eventuellen Ortstermin aufgewendeten Kosten (Gutachten, Reisekosten, usw.) zu erstatten.
**G.5.** Versteckte Mängel müssen dem Verkäufer innerhalb von 8 (acht) Tagen ab Feststellung des Mangels per Einschreiben mit Rückschein gemeldet werden; anderenfalls verfällt der Rechtsanspruch.
**G.6.** Die Aktion des Käufers zur Inanspruchnahme der Mängelhaftung muss in jedem Fall innerhalb von 12 (zwölf) Monaten ab der Lieferung der Produkte erfolgen.

### H.- MÄNGELHAFTUNG

**H.1.** Die Garantie des Verkäufers ist begrenzt auf Produkte erster Qualität und sie bezieht sich nicht auf Produkte zweiter oder dritter Qualität oder auf gelegentliche Partien mit besonderen Preisen oder Nachlässe, die in der Auftragsbestätigung angegeben werden.

**H.2.** Der Verkäufer garantiert nicht die Eignung der Produkte für besondere Verwendungen, sondern lediglich die technischen Eigenschaften, die auf der Web-Site in Dokument 2) Technische Datenblätter veröffentlicht sind. Die Angabe zur Verwendung ist als unverbindlich anzusehen, auch wenn vom Verkäufer in Katalogen und Handbüchern angegeben ist. Es ist stets Aufgabe des Planers, auf der Grundlage der in den 2) Technischen Datenblättern angegebenen Eigenschaften die Eignung des Produkts für spezifische Nutzungsbedingungen zu bewerten, unter Berücksichtigung der Belastungen sowie der Variablen, die am Ort der Bestimmung auftreten und die Eigenschaften verändern können, wie zum Beispiel die Intensität des Verkehrs, die Qualität des Verkehrs (Begehung bei Vorhandensein von Sand, Schmutz usw.), die eventuellen klimatischen Bedingungen sowie alle sonstigen Einflüsse, denen das Material ausgesetzt sein kann.

**H.3.** Falls festgestellt wird, dass das Produkt offensichtliche Mängel aufweist, wie definiert in Punkt G, Nr. 3, nimmt der Verkäufer die Ersetzung des mangelhaften Produkts durch ein anderes mit gleichen oder höherwertigen Eigenschaften vor, oder er nimmt eine angemessene Reduzierung des Preises vor, falls dies nicht möglich ist. Alternativ hat der Käufer nach Rücklieferung der mangelhaften Produkte das Recht auf Rückerstattung des bezahlten Preises, zuzüglich der Transportkosten, mit Ausschließung der Vergütung aller direkten und/oder indirekten Schäden.
**H.4.** Die Garantie des Verkäufer wird ausgeschlossen, falls das mangelhafte Produkt (ganz oder teilweise) verwendet und/oder umgewandelt worden ist, da davon ausgegangen wird, dass der Käufer (oder sein Kunde) dadurch seinen Willen zum Ausdruck gebracht hat, es in dem Zustand zu akzeptieren, in dem es sich befindet.
**H.5.** Falls festgestellt wird, dass das Produkt versteckte Mängel aufweist, ist die Garantie des Verkäufers auf die Ersetzung des Materials durch anderes mit gleichen oder höherwertigeren Eigenschaften beschränkt oder – falls dies nicht möglich ist – auf die Rückerstattung des bezahlten Preises, zuzüglich der Transportkosten. In jedem Fall ist die Garantie des Verkäufers für alle direkten und/oder indirekten Schäden, die durch das mangelhafte Produkt entstehen, auf einen Betrag begrenzt, der das Doppelte des Verkaufspreises nicht übersteigen kann, den der Verkäufer auf den mangelhaften Teil der Lieferung angewendet hat.

**H.6.** Falls der Käufer das Produkt an Kunden weiterverkauft, die vom Verbraucherschutzgesetz (ital. Gesetzerlass Nr. 206/2005) geschützt werden, ist er verantwortlich für die angewendeten Bedingungen, falls diese von den hier angegebenen abweichen, und er muss sicherstellen, dass die Rechte des Verbrauchers gemäß den Bestimmungen dieses Gesetzes ausgeübt werden können. Falls die Voraussetzungen gegeben sind, kann das Regressrecht des Käufers gegenüber dem Verkäufer/Hersteller nicht die Grenzen übersteigen, die von Punkt G, Nr. 1 bis Punkt H, Nr. 5 angegeben werden.

<p> <b>Technical Specifications</b></p>	
<p> INDEX</p>	<p> <b>≡</b></p>
<p> A COMPLETE PRODUCT SYSTEM</p>	<p> <b>&gt;</b></p>
<p> PRODUCT FINDER</p>	<p> <b>&gt;</b></p>
<p> SURFACE RANGE</p>	<p> <b>&gt;</b></p>
<p> COMPANY</p>	<p> <b>&gt;</b></p>
<p> COLLECTIONS</p>	<p> <b>&gt;</b></p>
<p> LARGE SIZES</p>	<p> <b>&gt;</b></p>
<p> SLABS FOR COUNTERTOPS &amp; FURNITURE</p>	<p> <b>&gt;</b></p>
<p> SINKS &amp; BATHROOM FURNISHING</p>	<p> <b>&gt;</b></p>
<p> FACADES</p>	<p> <b>&gt;</b></p>
<p> TECHNICAL SPECIFICATIONS</p>	<p> <b>&gt;</b></p>

**I. KLAUSEL SOLVE ET REPETE UND AUFLÖSUNGSKLAUSEL**
**I.1.** Gemäß den Bestimmungen von § 1462 des ital. Bürgerlichen Gesetzbuches kann der Käufer in keinem Fall – einschließlich von vermeintlichen Mängeln oder Defekten des Materials – die Zahlung des abgenommenen Materials aussetzen oder verzögern, natürlich vorbehaltlich des Rechts, ungerechtfertigt gezahlte Beträge zurückzufordern, und dies nur nach Erbringung des Nachweises der Rechtmäßigkeit der Forderung (Solve et Repete).
**I.2.** Im Fall der Veränderung der Vermögensbedingungen des Käufers oder der auch nur partiellen Nichtbezahlung der bereits gelieferten Produkte kann der Verkäufer die laufenden Lieferungen aussetzen und/oder die laufenden Verträge auflösen, ohne dass der Käufer die Vergütung von direkten und/oder indirekten Schäden geltend machen kann.

### L.- EIGENTUMSVORBEHALT

**L.1.** Bis zur vollständigen Bezahlung des Preises durch den Käufer bleiben die Produkte, die den Gegenstand der Lieferung darstellen, Eigentum des Verkäufers.
**L.2.** Während dieses Zeitraums übernimmt der Käufer die Pflichten und die Verantwortlichkeiten für die Aufbewahrung der gekauften Produkte und er kann sie nicht veräußern, zur Nutzung überlassen oder beschlagnahmen oder pfänden lassen, ohne das Eigentum des Verkäufers anzugeben und ohne diesen umgehend per Einschreiben mit Rückschein zu benachrichtigen.

### M.- HÖHERE GEWALT

**M.1.** Beide Parteien können die Ausführung der vertraglichen Pflichten aussetzen, wenn die Ausführung aus Gründen, die vom eigenen Willen unabhängig sind, unmöglich oder objektiv zu aufwendig wird, wie zum Beispiel: Streiks, Boykott, Aussperrung, Brand, Krieg (erklärt oder nicht), Bürgerkrieg, Aufstände und Revolutionen, Beschlagnahme, Embargo, Unterbrechungen der Energieversorgung, außerordentliche Defekte von Maschinen, Verspätung bei der Anlieferung von Komponenten und Rohstoffen.
**M.2.** Die Partei, die beabsichtigt, die vorliegende Klausel in Anspruch zu nehmen, muss der anderen Partei schriftlich das Auftreten von Umständen der Höheren Gewalt mitteilen.

**M.3.** Falls die Aussetzung aufgrund von Höherer Gewalt mehr als 60 (sechzig) Tage andauert, haben beiden Parteien das Recht, den vorliegenden Vertrag nach einer schriftlichen Vorankündigung von 10 (zehn) Tagen an die Gegenpartei aufzulösen.

### N.- VERTRAULICHKEITSPFLICHT

**N.1.** Der Käufer ist gehalten, über alle technischen Informationen (wie zum Beispiel Zeichnungen, Prospekte, Dokumentationen, Formeln und Schriftverkehr) und kommerziellen Informationen (einschließlich der Vertragsbedingungen, der Kaufpreise, der Zahlungsbedingungen usw.), in deren Kenntnis während der Ausführung des vorliegenden Vertrages kommt, absolute Vertraulichkeit einzuhalten.
**N.2.** Die Vertraulichkeitspflicht wird für die Dauer des Vertrages sowie den Zeitraum nach seiner Ausführung übernommen.
**N.3.** Im Fall der Nichteinhaltung der Vertraulichkeitspflicht ist die nicht einhaltende Partei gehalten, der anderen Partei alle daraus entstehenden Schäden zu vergüten.

### O.- MARKEN UND KENNZEICHNUNGEN DES VERKÄUFERS

**O.1.** Die Verwendung von Marken, Ziermotiven und geistigem Eigentum im Allgemeinen in jeder Form sowie jeder Ausdrucksform (als nicht erschöpfendes Beispiel: Bilder, Fotos, Zeichnungen, Filme, Abbildungen, Strukturen usw.), die intellektuelles Eigentum des Verkäufers sind, ist auf jede Weise (als nicht erschöpfendes Beispiel: Presse, Video, Radio, Internet, Social Media, Instant-Message-Plattform oder VoIP usw.) strengstens untersagt. Alle – auch nur partielle – Abweichungen von diesem Verbot müssen von Fall zu Fall schriftlich von der Generaldirektion des Verkäufers autorisiert werden.

**P.- SPRACHE DES VERTRAGS, ANWENDBARES RECHT, RECHTSPRECHUNG UND GERICHTSSTAND**
**P.1.** Der Vertrag und die vorliegenden Bedingungen werden in italienischer Sprache verfasst, die im Fall der Abweichung der Übersetzung in andere Sprachen Vorrang hat.
**P.2.** Die Regelung aller Rechtssachen hinsichtlich den Lieferungen unterliegt der Rechtsprechung des italienischen Staats und die territoriale Zuständigkeit liegt ausschließlich beim Bezirksgericht Modena, dem Ort des Firmensitzes des Verkäufers.

Weitere Informationen entnehmen Sie bitte den Allgemeinen Geschäftsbedingungen, die unter der Adresse www.atlasconcorde.com zur Verfügung stehen.

## Condiciones generales de venta

### A.- MODALIDADES DE CELEBRACIÓN DEL CONTRATO

**A.1.** Las presentes Condiciones Generales de Venta disciplinan todo contrato de venta entre el Vendedor y el Comprador y toda modificación o cancelación debe ser establecida por escrito.

**A.2.** Eventuales ofertas, acreditaciones y/o descuentos otorgados por agentes u otros intermediarios, no son considerados válidos mientras no sean confirmados por escrito por el Vendedor.

**A.3.** El Comprador envía al Vendedor, directamente o a través de agentes, pedidos por escrito que deben contener la indicación de los códigos de los productos requeridos, de las cantidades, de sus precios y de su destino. El pedido enviado por el Comprador es irrevocable.

**A.4.** La venta deberá considerarse perfeccionada desde el momento en que: (a) el Comprador recibe por parte del Vendedor una confirmación –escrita a través de e-mail, fax u otros medios telemáticos– conforme con los términos y según las condiciones del pedido; o (b) en caso de confirmación enviada por el Vendedor que contenga condiciones diferentes de las del pedido enviado por el Comprador cuando este las acepte por escrito o, en todo caso, no las cuestione dentro de los 7 (siete) días sucesivos a la recepción; o (c) en ausencia de confirmación escrita por el Vendedor, en el momento en que los productos serán entregados y serán cargados por el Comprador.

**A.5.** El Comprador comprende y acepta la necesidad de limitar al territorio nacional las ventas de los productos Atlas Concorde. El Vendedor estima que esta norma constituye un factor indispensable para poder coordinar su política comercial y racionalizar la red de distribución, con ofertas más orientadas a los requerimientos de cada país. De igual modo, el Comprador reconoce que este requerimiento constituye también salvaguardia de sus propios intereses. Por lo tanto, el Comprador se obliga a comercializar los productos suministrados por Ceramiche Atlas Concorde SpA exclusivamente en su país de residencia, absteniéndose de promover ventas activas, solicitadas incluso online, respecto a clientes domiciliados en el territorio de cualquier otro país que no sea el propio. Para operaciones triangulares esta obligación se aplica al país de operatividad efectiva del Comprador.

El Comprador podrá revender el producto fuera de su propio territorio en caso de recibir autorización por escrito por parte del Vendedor o en caso de que la reventa se refiera a productos que no sean de primera selección o que estén fuera de producción.

### B.- PRECIOS

**B.1.** Salvo acuerdo escrito en contrario, los precios de venta acordados de manera puntual se entienden al neto en efectivo y para entrega en el establecimiento del Vendedor indicado en la confirmación del pedido.

### C.- CARACTERÍSTICAS DE LOS PRODUCTOS

**C.1.** El Comprador declara haber visto y atenerse al contenido de la siguiente documentación publicada en el sitio internet de la empresa: 1) Manual de Colocación, Uso, Limpieza y Mantenimiento y 2) Fichas Técnicas.

**C.2.** Dada la intrínseca variabilidad del producto cerámico, las características de las muestras y/o modelos enviados anteriormente por el Vendedor al Comprador deben ser considerados como aproximados y no vinculantes.

**C.3.** Salvo especificaciones requeridas, a acordar antes de la confirmación del pedido, el Vendedor no garantiza que el pedido de un artículo en particular sea despachado como un mismo lote de producción.

### D.- PLAZOS DE ENTREGA

**D.1.** Los plazos de entrega son orientativos y su demora no conlleva derecho alguno a solicitar indemnización alguna por parte del comprador, sin excepciones.

**D.2.** Si el comprador no recogiera el material transcurridos 14 (catorce) días desde la fecha del aviso de estar lista la mercancía, por necesidad de espacio el vendedor se verá obligado a devolver dicho material al almacén, lo que conlleva unos costes añadidos reservándose el mismo la facultad de cargarlos al comprador.

### E.- ENTREGA Y TRANSPORTE

**E.1.** La eventual variación de lugar de destino de los productos, señalando uno diferente respecto de aquel acordado en la confirmación de pedido, debe ser comunicada por el Comprador por escrito dentro del plazo máximo taxativo del penúltimo día previo al retiro desde el establecimiento del Vendedor. El Vendedor se reserva la facultad de no aceptar el cambio de lugar de destino de los Productos. En caso de verificarse que el destino efectivo del producto sea diferente de aquel declarado por el Comprador, el Vendedor se reserva la facultad de suspender la realización de los suministros en curso y/o de rescindir los contratos

en curso sin que el Comprador pueda pedir resarcimientos directos y /o indirectos de ningún tipo.

**E.2.** Salvo acuerdo en contrario, el suministro de la mercancía se entiende ex Works (EXW según Incoterms 2010) y ello también cuando se acuerde que el transporte o parte de él quede a cargo del Vendedor, según mandato del Comprador. En todo caso, los riesgos se transfieren al Comprador a más tardar con la entrega al primer transportador.

**E.3.** Como confirmación del hecho de que el Vendedor es ajeno al contrato de transporte, el mismo no podrá ser indicado como “shipper” en la póliza de carga. La comunicación del peso bruto del contenedor al transportista no comporta ninguna asunción de responsabilidad de parte del Vendedor para los fines del Convenio SOLAS (Safety Of Life At Sea). De ninguna manera la antedicha comunicación podrá ser considerada como VGM (Verified Gross Mass).

**E.4.** El Comprador se compromete a fin de que el vehículo enviado al establecimiento del Vendedor sea idóneo para cargar considerando la naturaleza de los productos. En caso de que el vehículo que se presenta comporte significativas dificultades para las operaciones de carga, el Vendedor se reserva el derecho a incluir una recarga del 4 % del valor de los productos a cobertura de los mayores costos logísticos. Si el vehículo enviado para retirar la mercancía no es absolutamente idóneo, el Vendedor se reserva la facultad de negar las operaciones de carga sin que nada pueda requerir el Comprador a título de resarcimiento por todo eventual costo directo y/o indirecto que de ello pueda derivar.

**E.5.** Es tarea del Comprador encargar al transportista controlar los productos antes de cargarlos; eventuales observaciones sobre la integridad de los embalajes y la exactitud de las cantidades cargadas, así como aquellas puestas en el documento de transporte, deben ser presentadas por el transportista en el momento de cargar. Estas observaciones deben ser reproducidas en todas las copias de los documentos de transporte; de lo contrario los productos cargados se entienden íntegros y completos. De ello deriva que el Vendedor no se asume ninguna responsabilidad con referencia a faltas o daños en los productos no señalados por el transportista.

**E.6.** Asimismo, es responsabilidad del Comprador encargar al transportista verificar las modalidades y la estabilidad de la carga sobre el vehículo a fin de que durante el transporte no se produzcan roturas y que sean respetadas todas las disposiciones sobre seguridad relativas a la circulación por vías públicas.

### F.- PAGOS

**F.1.** Toda obligación de pago debe ser cumplida en la sede legal del Vendedor. Eventuales pagos a agentes, representantes o auxiliares de comercio no se entienden efectuadas mientras las respectivas sumas no lleguen a poder del Vendedor.

**F.2.** Queda prohibido para el Comprador cumplir su propia obligación mediante pagos provenientes de países que no sean su propio país de residencia si se trata de países que no garantizan adecuado intercambio de informaciones con Italia. En caso de violación de esta prohibición, el Vendedor tiene facultad de rescindir el contrato por justa causa sin que el Comprador pueda pretender derecho de obtener algún resarcimiento por eventual daño sufrido.

**F.3.** Eventuales gastos de sello fiscal y de cobro de letras de cambio y efectos comerciales quedan a cargo del Comprador. En caso de incumplimiento, incluso solo parcial, del día fijado para el pago, se devengarán a favor del Vendedor los intereses de mora en la medida prevista por el Decreto Leg. n. 231 del 09/10/2002.

**F.4.** Salvo acuerdos escritos que lo contradigan, el Comprador se compromete a no compensar ningún crédito de cualquier forma creado respecto del Vendedor.

### G.- RECLAMOS

**G.1.** Al recibir los productos, el Comprador deberá someterlos a cuidadoso control a través de un examen visual efectuado conforme según las indicaciones del punto 7.4 de las normas UNI EN ISO 10545-2.

**G.2.** La instalación y colocación de los productos deberá efectuarse respetando escrupulosamente las recomendaciones inherentes a las actividades a realizar antes y durante la colocación, indicadas en el documento 1) Manual de Colocación, Uso, Limpieza y Mantenimiento publicado en el sitio internet del Vendedor y en el embalaje del producto y/o en el interior del mismo. No son considerados como vicios del producto aquellos generados por una errónea instalación y error/falta de mantenimiento (intervenciones diferentes de las instrucciones proporcionadas en el 1) Manual de Colocación, Uso, Limpieza y Mantenimiento), por un uso inapropiado y/o por el normal desgaste con el pasar del tiempo.

**G.3.** Sin perjuicio de los límites de aceptabilidad previstos por la norma internacional EN 14411 (ISO 13006), las partes reconocen como vicios evidentes los defectos de

los productos constatables ya en el momento de su recepción y tales que impidan el uso previsto del material o reduzcan de modo apreciable su valor. Forman parte de esta categoría los defectos precisamente establecidos en el documento 1) Manual de Colocación, Limpieza y Mantenimiento publicado en el sitio internet del Vendedor. A título solo de ejemplo, se reconocen como vicios evidentes los defectos superficiales, los defectos de decoración, de lapeado/pulido, de calibre, de planitud, de ortogonalidad-rectilineidad, de espesor, las grietas, los astillados, las variaciones de tono, los tonos mezclados y los productos que presentan problemas de cortes/escamas.

**G.4.** En caso de que el Comprador observe la presencia de vicios evidentes, deberá presentar reclamo al Vendedor por escrito, so pena de extinción del derecho, dentro de los 8 (ocho) días sucesivos a la recepción y mantener a disposición del Vendedor la partida completa de material. El reclamo deberá indicar los datos de facturación y una precisa descripción del vicio observado incluyendo, en lo posible, imágenes fotográficas. En caso de que el reclamo debiera demostrarse luego ser infundado, el Comprador se declara dispuesto a resarcir al Vendedor por los gastos efectuados para realizar la respectiva constatación in situ (peritajes, viajes, etc.).

**G.5.** Los vicios ocultos deberán ser notificados al Vendedor mediante carta certificada con aviso de recibo, bajo pena de caducidad de la garantía, dentro de los 8 (ocho) días a contar de la fecha del descubrimiento del defecto.

**G.6.** La acción del Comprador tendiente a hacer valer la garantía por vicios prescribe, en todo caso, en el plazo de 12 (doce) meses a contar de la entrega de los productos.

### H.- GARANTÍA POR VICIOS

**H.1.** La garantía del Vendedor se entiende limitada solo a los productos de primera selección y no a los productos de segunda o tercera selección o de partidas de ocasión con precios o descuentos especiales cuando ello se encuentra debidamente señalados en nota en la confirmación del pedido.

**H.2.** El Vendedor no garantiza la idoneidad de los productos para usos particulares, sino solo las características técnicas publicadas en el sitio internet, documento 2) Fichas Técnicas. La indicación de uso, incluso cuando es presentada por el Vendedor en catálogos y manuales, debe considerarse solo como genérica. Sobre la base de las características técnicas señaladas en las 2) Fichas Técnicas, es siempre tarea del proyectista evaluar la idoneidad del producto en función de las condiciones específicas de uso en consideración de las solicitudes y de las variables que pueden operar en el ambiente de destino, alterando sus características; a título de ejemplo: la intensidad del tráfico, la calidad del tráfico (tránsito en presencia de arena, de detritos, etc.), las eventuales condiciones climáticas adversas y cualquier otro factor aleatorio al que puede quedar expuesto el material.

**H.3.** En caso de comprobarse que el producto manifieste vicios evidentes, tal como han sido definidos en la letra G n. 3, el Vendedor procederá a sustituir el producto defectuoso con otro con características iguales o superiores o, en el caso de que ello no sea posible, deberá efectuar una congrua reducción del precio. Como alternativa, el Comprador tendrá derecho, previa devolución de los productos viciados, al reembolso del precio pagado, agregándose el costo del transporte, con exclusión del resarcimiento de todo otro daño, directo y/o indirecto.

**H.4. La garantía del Vendedor debe considerarse excluida en caso de que el producto que presenta vicios evidentes (total o parcialmente) haya sido utilizado y/o, en cualquier caso, transformado, debiéndose estimar que de tal modo el Comprador (o su cliente) ha expresado la voluntad de aceptarlo en el estado en que se encuentra.**
**H.5. En los casos en que quede comprobado que el producto presenta vicios ocultos, la garantía del Vendedor queda limitada a la sustitución del material con otro de características iguales o superiores y, allí donde ello no sea posible, al reembolso del precio pagado, agregándose el costo del transporte. En todo caso, la garantía del Vendedor por cada daño directo y/o indirecto de cualquier forma derivado de producto defectuoso, debe entenderse limitada a una suma que no podrá superar el doble del precio de venta aplicado por el Vendedor, con referencia solo a la parte defectuosa del suministro.**

**H.6.** En caso de que el Comprador revenda el producto a terceros protegidos por el código del consumo (D.L. n. 206/2005), será responsable de las condiciones practicadas si son diferentes de aquellas aquí señaladas y deberá comprobarse que los derechos del consumidor sean ejercidos con aplicación de los remedios y de los términos fijados por el antedicho código. En caso de subsistir las condiciones, el derecho de devolución y/o, en todo caso, de compensación a favor del Comprador respecto del Vendedor/productor, no podrán excederse las exenciones ni límites establecido en la letra G del n. 1 y en la letra H n. 5.

INDEX	☰
REV. 3 DE 1 DE SEPTIEMBRE 2020	
<b>A COMPLETE PRODUCT SYSTEM</b>	➤
<b>PRODUCT FINDER</b>	➤
<b>SURFACE RANGE</b>	➤
<b>COMPANY</b>	➤
<b>COLLECTIONS</b>	➤
<b>LARGE SIZES</b>	➤
<b>SLABS FOR COUNTERTOPS &amp; FURNITURE</b>	➤
<b>SINKS &amp; BATHROOM FURNISHING</b>	➤
<b>FACADES</b>	➤
<b>TECHNICAL SPECIFICATIONS</b>	➤

Para mayor información, consultar las Condiciones Generales de Venta, disponible en la dirección [www.atlasconcorde.com](http://www.atlasconcorde.com)

## Общие условия продажи

**A.- ПОРЯДОК ЗАКЛЮЧЕНИЯ ДОГОВОРА**

**A.1.** Настоящие Общие условия продажи регулируют любой договор продажи, заключенный между Продавцом и Покупателем; любое изменение или отступление от них должно быть согласовано в письменной форме.

**A.2.** Возможные коммерческие предложения, зачисления и/или бонусы, предоставленные агентами или другими посредниками, не имеют силы, если они не были подтверждены в письменной форме Продавцом.

**A.3.** Покупатель направляет Продавцу непосредственно или через агентов письменные заказы, в которых должны быть указаны коды запрошенной продукции, количества, цены и место назначения. Отправленный Покупателем заказ отмене не подлежит.

**A.4.** Продажа считается завершенной в тот момент, когда: (i) Покупатель получает от Продавца по электронной почте, факсу или другим телематическим средствам связи письменное подтверждение, соответствующее срокам и условиям заказа; или (ii) в случае, если в отправленном Продавцом подтверждении указаны условия, отличающиеся от условий в заказе Покупателя, если Покупатель письменно принимает это подтверждение или не возражает на него в течение 7 (семи) дней после его получения; или (iii) при отсутствии письменного подтверждения Продавца, в тот момент, когда Продукция передается Покупателю и загружается им.

**A.5.** Покупатель соглашается с необходимостью ограничить территорию продажи продукции Atlas Concorde государственными границами. Продавец считает это правило необходимым элементом, который позволит ему координировать свою коммерческую политику и оптимизировать дистрибутивную сеть посредством предложений, которые будут больше соответствовать потребностям отдельных стран. Аналогично этому, Покупатель соглашается, что эта необходимость представляет собой защиту также и его интересов. Таким образом, Покупатель обязуется реализовывать продукцию, поставленную компанией Ceramiche Atlas Concorde SpA, лишь только в его стране, воздерживаясь от продвижения активной продажи, также онлайновой, клиентам, находящимся на территории другой страны. В операциях триангуляции данное обязательство распространяется на страну, в которой ведется реальная оперативная деятельность Покупателя.

Покупатель сможет перепродать продукцию за пределами своей территории в том случае, если он получит письменное разрешение Продавца, или же в случае перепродажи продукции не первого сорта или снятой с производства.

**В.- ЦЕНЫ**

**В.1.** При отсутствии иных письменных договоренностей согласованные в каждом отдельном случае отпускные цены подразумеваются как цены нетто, за наличный расчет и на условиях поставки франко завод Продавца, указанный в подтверждении заказа.

**C.- ХАРАКТЕРИСТИКИ ПРОДУКЦИИ**

**C.1.** Покупатель заявляет, что он ознакомился и придерживается содержания следующей документации, размещенной на корпоративном сайте в интернете: 1) Руководство по укладке, использованию, чистке и уходу и  2) Технические данные.

**C.2.** Учитывая свойственное непостоянство керамической продукции, характеристики образцов и/ моделей, ранее отправленных Продавцом Покупателю, должны считаться ориентировочными и не обязывающими.

**C.3.** При отсутствии специальных требований, которые должны быть оговорены до подтверждения заказа, Продавец не гарантирует, что заказ на отдельное изделие будет полностью состоять из одной и той же производственной партией.

**D.- СРОКИ ПОСТАВКИ**

**D.1.** Сроки поставки являются ориентировочными: их продление не дает Покупателю права на запрос компенсаций, без каких-либо исключений.

**D.2.** Если по истечении 14 (четырнадцать) дней с даты уведомления о готовности товара Покупатель не заберет материал, Продавец будет вынужден, по причине занимаемой площади, вернуть материал на склад, что приведет к дополнительным расходам; Продавец оставляет за собой право взыскать такие дополнительные расходы с Покупателя.

**E.- ДОСТАВКА И ОТГРУЗКА**

**E.1.** О возможном изменении места назначения Продукции, если оно отличается от места, согласованного в подтверждении заказа, необходимо сообщить Продавцу в письменной форме не позднее, чем за два дня до даты, предусмотренной для вывоза товара с завода Продавца. Продавец оставляет за собой право не принимать изменение места назначения Продукции. Если устанавливается, что фактическое место назначения Продукции отличалось от заявленного Покупателем, то Продавец оставляет за собой право приостановку исполнения текущих поставок и/или на расторжение

текущих договоров без права Покупателя на требование прямого или косвенного возмещения какого-либо типа.

**E.2.** При отсутствии иных договоренностей поставка товара подразумевается на условиях франко-завод (EXW в соответствии с правилами Incoterms 2010), даже если было согласовано, что отгрузка или ее часть должна осуществляться Продавцом по поручению Покупателя. В любом случае риск переходит к Покупателю не позднее чем при передаче товара первому грузоперевозчику. **E.3.** Исходя из того, что Продавец не является стороной договора перевозки, в нососаменте не допускается указание Продавца как "грузоотправителя". Сообщение Продавцом грузоперевозчику веса брутто контейнера не является принятием на себя ответственности в соответствии с конвенцией СОЛАС (Safety Of Life At Sea). Это сообщение не может ни в коем случае толковаться как проверка массы груженых контейнеров VGM (Verified Gross Mass).

**E.4.** Покупатель обязуется направить на склад Продавца транспортное средство, пригодное для погрузки Продукции данного типа. Если прибывшее транспортное средство значительно затрудняет выполнение погрузочных операций, то Продавец оставляет за собой право наложить пени в размере 4% от стоимости продукции за возмещение более высоких логистических расходов. Если согласованное транспортное средство является совершенно неподходящим, Продавец оставляет за собой право отказать в выполнении погрузочных операций, при этом Покупатель не может требовать возмещения вытекающего из этого любого прямого и/или косвенного убытка.

**E.5.** Покупатель обязан поручить грузоперевозчику проверку продукции перед ее погрузкой. Возможные замечания о целостности упаковки и о соответствии загруженных количеств тем, которые указаны в транспортной накладной, должны быть сделаны грузоперевозчиком в момент погрузки. Эти замечания необходимо указать во всех копиях транспортных накладных, в противном случае погруженная продукция считается неповрежденной и комплектной. Из этого следует, что  Продавец не несет никакой ответственности за недостатки или повреждения продукции, не отмеченные грузоперевозчиком.

**E.6.** Кроме того, Покупатель также обязан поручить грузоперевозчику проверку порядка погрузки и стабильности груза в транспортном средстве, чтобы во время перевозки не возникли повреждения, и чтобы были соблюдены все правила безопасности дорожного движения.

**F.- ОПЛАТА**

**F.1.** Любые платежные обязательства должны выполняться по юридическому адресу Продавца.Оплата агентам, представителям или торговым помощникам считается несовершенной до тех пор, пока соответствующие суммы не поступят Продавцу.

**F.2.** Покупателю запрещается выполнять свои обязательства путем оплаты из стран, не являющихся страной, резидентом которой он является, если эти страны не гарантируют адекватный обмен информацией с Италией. В случае нарушения этого запрета Продавец имеет право на расторжение договора с надлежащим правовым основанием, а у Покупателя не возникнет право на получение какого-либо возмещения за понесенный ущерб.

**F.3.** Пошлины и расходы на инкассирование векселей и тратт несет Покупатель. В случае даже частичной задержки платежа по сравнению с  назначенным днем оплаты в пользу Продавца будут начисляться проценты в размере, предусмотренном законодательным декретом от 09/10/2002 № 231.

**F.4.** При отсутствии иных письменных договоренностей Покупатель обязуется не компенсировать никакой кредит по отношению к Продавцу, вне зависимости от причин его возникновения.

**G.- ПРЕТЕНЗИИ**

**G.1.** При получении Продукции Покупатель должен внимательно осмотреть ее в соответствии с указаниями п. 7 стандарта UNI EN ISO 10545-2

**G.2.** При установке и укладке Продукции необходимо внимательно придерживаться рекомендаций по работам, выполняемым до и во время укладки, приведенных в документе 1) Руководство по укладке, использованию, чистке и уходу, размещенном на сайте Продавца в интернете, а также рекомендаций, указанных на упаковке изделия и/или приведенных внутри упаковки. Не считаются дефектами Продукции дефекты, возникшие в результате неправильной установки, отсутствия / неправильного ухода (не в соответствии с указаниями, приведенными в 1) Руководстве по укладке, использованию, чистке и уходу), по причине неподходящей сферы применения и/или обывчного износа с течением времени.

**G.3.** Соблюдая пределы приемлемости, предусмотренные международным стандартом EN 14411 ( ISO 13006), стороны признают как явные дефекты те дефекты Продукции, которые были заметными уже при ее получении, и которые делают материал неподходящим для применения или существенно снижают его ценность. В эту категорию входят дефекты в соответствии с определением, приведенным в

документе 1) Руководство по укладке, использованию, чистке и уходу, размещенном на сайте Продавца в интернете. В качестве неисчерпывающего перечня признаются как явные дефекты следующие: дефекты поверхности, декора, шлифовки/полировки, калибра, плоскостности, ортогональности-прямолинейности, толщины, трещины, сколы, несоответствие тона, смещение тона, а также изделия с дефектами резки и сколами.

**G.4.** Если Покупатель обнаруживает явные дефекты, то он должен предъявить претензию Продавцу в письменном виде в течение 8 (восьми) дней с момента получения Продукции, в противном случае он теряет право на претензию, кроме того, Покупатель должен оставить всю партию материала в распоряжении Продавца. В претензии необходимо указать данные инвойса и точное описание дефекта, сопровождая его, если это возможно, фотографиями. Если претензия окажется необоснованной, то Покупатель должен быть готовым возместить Продавцу расходы, понесенные им в связи с осмотром на месте (экспертизы, проезд и т.д.).

**G.5.** О скрытых дефектах необходимо сообщать Продавцу заказным письмом с уведомлением о вручении в течение не более 8 (восьми) дней с момента обнаружения дефекта, в противном случае гарантия теряет силу.

**G.6.** В любом случае, предоставленная Покупателю гарантия на дефекты теряет силу по истечении 12 (двенадцати) месяцев с момента получения Продукции.

**H.- ГАРАНТИЯ НА ДЕФЕКТЫ**

**H.1.** Гарантия Продавца распространяется только на Продукцию первого сорта, и не распространяется на Продукцию второго, третьего сорта, а также на партии со спецпредложениями, по которым были предложены специальные скидки или цены, отмеченные в примечаниях в подтверждении заказа.

**H.2.** Продавец не гарантирует пригодность Продукции для специальных видов применения, а лишь только ее технические характеристики, размещенные на сайте в интернете, в документе 2) Технические данные. Сфера применения, даже если она указана Продавцом в каталогах и руководствах, должна считаться лишь только ориентировочной. На основании технических характеристик, приведенных в 2) Технические данных, проектировщик обязан оценить пригодность Продукции к конкретным условиям применения, в зависимости от нагрузок и от переменных факторов, которые могут возникнуть в среде применения, изменяя характеристики Продукции, такие как: интенсивность хождения, качество хождения (наличие песка, мусора и т.д.), возможные неблагоприятные климатические условия и любые другие случайные факторы, которые могут оказать воздействие на материал.

**H.3.** В случае установления того факта, что Продукция имеет явные дефекты в соответствии с положениями п. 3 раздела G, Продавец заменит дефектную Продукцию другой, обладающей такими же или более высокими характеристиками. Если это невозможно, то он надлежащим образом снизит цену. В качестве альтернативы после возврата дефектной Продукции Покупатель имеет право на возмещение уплаченной цены и транспортных расходов, при этом исключено возмещение любого другого прямого и/или косвенного ущерба.

**H.4. Гарантия Продавца считается отмененной в случае, если Продукция, частично или полностью имеющая явные дефекты, была использована и/или трансформирована каким-либо образом, поскольку считается, что этими действиями Покупатель (или его клиент) выразил волю принять Продукцию в том состоянии, в котором она находится.**

**H.5. В случае установления того факта, что Продукция имеет скрытые дефекты, гарантия Продавца ограничена заменой материала другим, обладающим такими же или более высокими характеристиками. Если это невозможно, то Продавец возместит уплаченную цену и транспортные расходы. В любом случае, гарантия Продавца на любой прямой и/или косвенный ущерб, вызванный каким-либо образом дефектной Продукцией, ограничена суммой, которая не может превышать больше, чем в два раза, востребованную Продавцом отпускную цену, и лишь только в отношении к дефектной части поставки.**

**H.6.** Если Покупатель перепродает Продукцию лицам, которые защищены Кодексом потребителя (законодательный декрет № 206/2005), то он несет ответственность за предоставляемые условия, если они отличаются от приведенных здесь, кроме того, он обязан удостовериться в том, что права потребителя защищаются с соблюдением мер и сроков, предусмотренных вышеуказанным Кодексом.При наличии соответствующих предпосылок право регресса и/или право на взыскание убытков, которое Покупатель имеет по отношению к Продавцу/производителю, не может превышать исключения и пределы, установленные в п. 1 раздела G и в п. 5 раздела H.

#### Technical Specifications

КОРРЕКТИРОВКА 3 ОТ 1 СЕНТЯБРЯ 2020 Г.

**I. УСЛОВИЯ ОБ ОБЯЗАТЕЛЬНОЙ ОПЛАТЕ (SOLVE ET REPETE) И О ДОСРОЧНОМ ОДНОСТОРОННОМ РАСТОРЖЕНИИ**

**I.1.** В соответствии со ст. 1462 гражданского кодекса Покупатель не вправе ни по какой причине, в том числе в связи с претензиями по поводу качества или дефектности товара, приостанавливать или задерживать оплату вывезенного материала, сохраняя, тем не менее, право требовать возмещение, если он докажет неправомерное взимание оплаты.

**I.2.** В случае изменения имущественного положения Покупателя или даже частичной неоплаты уже поставленной Продукции, Продавец может приостановить исполнение текущих поставок и/или расторгнуть текущие договоры, и Покупатель не имеет права потребовать какого-либо возмещения прямых и/или косвенных убытков.

**L.- ПОЛОЖЕНИЕ О СОХРАНЕНИИ ПРАВА СОБСТВЕННОСТИ**

**L.1.** Поставляемая Продукция будет оставаться в собственности Продавца до тех пор, пока Покупатель полностью не оплатит ее.

**L.2.** В течение этого периода Покупатель несет обязательства и ответственность хранителя и не может уступать, предоставлять в пользование, разрешать наложение имущественного ареста или опись Продукции, не заявив, что она находится в собственности Продавца, и не известив его немедленно заказным письмом с уведомлением о вручении.

**M.- ФОРС-МАЖОР**

**M.1.** Любая из сторон имеет право приостановить исполнение своих контрактных обязательств, если это исполнение стало невозможным или объективно обременительным по причине непредвиденных событий, находящихся вне ее контроля, таких как, например: забастовка, бойкот, локаут, пожар, война (объявленная или нет), гражданская война, бунт, революция, конфискация, эмбарго, энергетическая блокада, непредвиденный выход из строя оборудования, задержки в поставках компонентов или сырья.

**M.2.** Сторона, желающая сослаться на настоящее условие, должна немедленно сообщить в письменной форме другой стороне о возникновении и прекращении форс-мажорных обстоятельств.

**M.3.** Если приостановка в связи с форс-мажорными обстоятельствами продлится более 60 (шестидесяти) дней, то каждая из сторон имеет право расторгнуть настоящий договор, отправив предварительное письменное уведомление об этом другой стороне за 10 (десять) дней.

**N.- ОБЯЗАТЕЛЬСТВО О НЕРАЗГЛАШЕНИИ КОНФИДЕНЦИАЛЬНОЙ ИНФОРМАЦИИ**

**N.1.** Покупатель обязан соблюдать максимальную конфиденциальность о всей информации технического характера (такая как, но не ограничиваясь этим, чертежи, проспекты, документация, формулы и переписка) и коммерческого характера (включая договорные условия, отпускные цены, условия платежа и т.д.), которая попала в его распоряжение в ходе исполнения настоящего договора.

**N.2.** Обязательство о неразглашении конфиденциальной информации действует в течение всего срока действия договора, а также в период после его исполнения.

**N.3.** В случае невыполнения обязательства о неразглашении конфиденциальной информации невыполняющая сторона обязана возместить другой стороне все убытки, вытекающие из ее нарушения.

**O.- ТОРГОВЫЕ МАРКИ И ОТЛИЧИТЕЛЬНЫЕ ЗНАКИ ПРОДАВЦА**

**O.1.** Категорически запрещается использование торговых марок, орнаментальных промышленных образцов и предметов интеллектуальной собственности вообще, в любом виде или форме выражения (например, только в качестве неполного перечня: изображения, фотографии, чертежи, видеосъемки, рисунки, конструкции и т.д.), являющихся интеллектуальной собственностью Продавца, в любых СМИ (например, только в качестве неполного перечня: печать, видеоканалы, радиовещание, интернет, социальные сети, платформы для обмена сообщениями или VoIP-платформы). Любое, даже только частичное отступление от этого запрета должно письменно разрешаться в каждом отдельном случае Генеральной дирекцией Продавца.

**P.- ЯЗЫК ДОГОВОРА, ПРИМЕНИМЫЙ ЗАКОН, ЮРИСДИКЦИЯ И КОМПЕТЕНЦИЯ**

**P.1.** Договор и настоящие условия составлены на итальянском языке, который преобладает в случае разночтений с переводом на другие языки.

**P.2.** Любой спор, каким-либо образом связанный с поставками, регулируется итальянским законом и подлжит юрисдикции Итальянского государства, а территориальная компетенция принадлежит исключительно суду г. Модены, в округе которого Продавец имеет свой юридический адрес.

Больше информации можно найти в Общих условиях продажи по адресу [www.atlasconcorde.com](http://www.atlasconcorde.com)



INDEX



A COMPLETE  
PRODUCT  
SYSTEM



PRODUCT  
FINDER



SURFACE  
RANGE



COMPANY



COLLECTIONS



LARGE SIZES



SLABS FOR  
COUNTERTOPS  
& FURNITURE



SINKS &  
BATHROOM  
FURNISHING



FACADES



TECHNICAL  
SPECIFICATIONS





Flisestudiet A/S • Anelystparken 35 B • 8381 Tilst  
Tlf.: 87245026 • Mail.: flisestudiet@flisestudiet.dk

**[www.flisestudiet.dk](http://www.flisestudiet.dk)**